

DOUGLAS COUNTY MASTER PLAN

2017 Douglas County Transportation Plan

Prepared for



Adopted - April 30, 2019
Douglas County Board of Commissioners

Prepared by

PARSONS

FINAL DRAFT
August 2017

ACKNOWLEDGEMENTS

Douglas County Board of Commissioners

Dave Nelson, Commissioner

John Engels, Commissioner

Larry Walsh, Vice Chairman

Wesley Rice, Commissioner

Barry Penzel, Chairman

Douglas County Planning Commission

Margaret Pross, Chair

Anje de Knijf, Vice Chair

James Beattie

Jo Etta Brown

Bryan Davis

Frank Godecke

James R. Madsen

Douglas County Staff

Larry Werner, County Manager

Mimi Moss, AICP, Director—Community Development Department

Mark B. Jackson, County District Attorney

Erik Nilssen, PE, County Engineer—Community Development Department

Jon Erb, PE, Senior Civil Engineer—Public Works Department

Parsons Team

Jeff Foltz, PE, Project Manager

Sathya Thyagaraj, Traffic Analysis

Bob Scales, Traffic Demand Analysis

Sandi Domingue, Principal Transportation Planner

Walt Allen, Principal Transportation Planner



2017 Douglas County Transportation Plan

CONTENTS

Chapter		Page
1	INTRODUCTION	1
	1.1 Overview	1
	1.2 Updating the 2007 Transportation Plan	1
	1.3 Goals and Policies of the Transportation Plan	2
	1.3.1 Goals	3
	1.3.2 Policies	3
2	HISTORIC AND PROJECTED GROWTH	7
	2.1 Residential Capacity	7
	2.2 Projected Growth	11
	2.3 Commute Patterns within Douglas County and Carson City	15
	2.4 Growth Policies	22
	2.4.1 Evaluate the impacts of current and planned development in Douglas County	22
	2.4.2 Coordinate transportation planning and land use development	22
3	DOUGLAS COUNTY/CARSON CITY TRAVEL DEMAND MODEL	23
	3.1 How Travel Demand Modeling Works	23
	3.2 Overview of the Douglas County/Carson City Model	24
	3.3 Forecasting in the <i>2017 Douglas County Transportation Plan</i>	24
	3.4 Travel Demand Model Policies	26
	3.4.1 Update the travel demand on a regular basis, at least every ten years	26
	3.4.2 Maintain accurate data on population, employment and average daily traffic to facilitate travel model update	26
4	STREETS AND HIGHWAYS	27
	4.1 Assessment of Existing Conditions	27
	4.1.1 Functional Classification	27
	4.1.2 Existing Traffic Levels	29
	4.1.3 Quantitative Evaluation/Level of Service	30
	4.1.4 Existing Performance and Near-Term Challenges	38
	4.2 Vision/Guiding Policies and Principles	39
	4.2.1 Identify high accident locations and take appropriate actions to ensure continued public health and safety	39
	4.2.2 Provide appropriate traffic control devices on new and existing transportation facilities	39
	4.2.3 Protect public safety by removing snow and other hazards from roadways	39
	4.2.4 Post appropriate speed limits based on current speed limit studies..	39



2017 Douglas County Transportation Plan

CONTENTS (Continued)

Chapter		Page
	4.2.5 Remove litter, trash and debris from the roadside and the right-of-way to keep roadways within Douglas County aesthetically pleasant	39
	4.2.6 Implement selected near-term traffic safety and traffic operations improvements from 2017 to 2020	39
	4.2.7 Implement mid-term road improvements to provide acceptable traffic operations from 2017 to 2025	39
	4.2.8 Implement long-term road improvements to provide capacity and mobility from 2026 to 2040	39
	4.2.9 Maintain a level of service “D” on all NDOT roads within Douglas County, consistent with NDOT standards.....	39
	4.2.10 Develop a “pedestrian-friendly” U.S. 395/Main Street corridor through Minden and Gardnerville	40
	4.2.11 Support NDOT projects that maintain traffic flow (high speed and capacity) on U.S. 395 between Minden and Carson City, as identified in the U.S. 395 Southern Sierra Corridor Study (2007) ..	40
	4.2.12 Support possible bypass facilities to keep traffic moving through Minden and Gardnerville	40
	4.2.13 Develop a truck routes plan to keep excessive through traffic out of neighborhoods	41
	4.2.14 Resolve/prevent neighborhood traffic issues by providing adequate through traffic facilities on major collectors and arterials	41
	4.2.15 Provide traffic transitional facilities (such as traffic circles/roundabouts) in the Minden/Gardnerville area	41
	4.2.16 Maintain a current map of proposed Douglas County transportation improvement projects	41
	4.2.17 Maintain current design standards for Douglas County roadway classifications as identified in the <i>Douglas County Design Criteria and Improvements Standard Manual</i>	41
	4.2.18 Maintain a traffic level of service “C” or better on all Douglas County streets and roadways	42
	4.2.19 Provide transitional facilities between higher and lower classes of roadway functional types	42
4.3	Transportation Capital Improvement Projects	42



2017 Douglas County Transportation Plan

CONTENTS (Continued)

Chapter	Page
4.4	Near-Term Improvement Projects Identified in the <i>U.S. 395 Southern Sierra Corridor Study (2007)</i> 43
4.4.1	Acceleration/Deceleration Lanes 45
4.4.2	Access Management 46
4.4.3	Alternate Routes 46
4.4.4	Pavement Markings 46
4.4.5	Roundabouts 46
4.4.6	Traffic Signal Installation and Coordination 47
4.4.7	Implementation of Near-Term Improvements 47
4.4.8	Intersections along U.S. 395 in the Town of Minden 49
4.4.9	Driveways along U.S. 395 in the Towns of Minden and Gardnerville 49
4.4.10	State Route 88 Intersections 50
4.5	Needs Assessment for Future Development 51
4.6	Douglas County Street and Highway Design Standards 59
4.7	Emergency Access Routes and Flooding 59
4.8	Complete Streets 59
5.0	PUBLIC TRANSPORTATION ELEMENT 62
5.1	Existing Public Transportation Services 62
5.1.1	Douglas Area Rural Transit (DART) Dial-A-Ride 62
5.1.2	DART Express 63
5.1.3	BlueGo Transit Service 64
5.1.4	Carson Valley Airporter 67
5.1.5	Eastern Sierra Transit 67
5.2	Evaluating Douglas County Transit Services 68
5.2.1	Performance Measures 69
5.2.2	Performance Indicators 69
5.3	Public Transportation Needs Assessment and Issues 70
5.4	Future Transportation Options 72
5.4.1	Carson Valley/Lake Tahoe Gondola 72
5.4.2	Virginia and Truckee Railroad 74
5.5	Public Transportation Policies 76
5.5.1	Provide general public transit service to Douglas County residents and visitors 76
5.5.2	Provide transit services to the elderly and persons with disabilities, as required by the Americans with Disabilities Act 76



2017 Douglas County Transportation Plan

CONTENTS (Continued)

Chapter		Page
	5.5.3 Provide regional public transit, connecting Douglas County residents and visitors with Carson City, Washoe County and Alpine County (California)	76
	5.5.4 Promote use of local and regional public transit serving Douglas County residents and visitors	76
	5.5.5 Develop public transit goals and objectives to measure the transit system performance	76
	5.5.6 Annually review performance measures and indicators for existing transit services and adjust services accordingly	76
	5.5.7 Prepare a short range transit plan by 2018, including a five-year transit project list, which identifies transit needs and potential service improvements along with a financial plan	76
	5.5.8 Establish and preserve a transportation corridor in the vicinity of the former Virginia & Truckee railroad right-of-way between Minden and the Carson City line, parallel to Heybourne Road	76
	5.5.9 Evaluate the feasibility of providing rubber-tire transit service to initially serve major travel destinations as development occurs along the Heybourne Road corridor. Identify potential private and public funding sources to establish and maintain service	76
	5.6 Public Transportation Financial Considerations	76
6.0	BICYCLE/PEDESTRIAN/TRAILS ELEMENT	77
6.1	Bicycle/Pedestrian/Trails Policies	79
	6.1.1 Maintain and implement the adopted <i>Douglas County Comprehensive Trails Plan</i> to provide opportunity for non-motorized transportation within the county that meets both recreational and commuter needs.	79
	6.1.2 Ensure development and maintenance of multi-purpose (hiking, equestrian, bikeway and off-road bicycle) trail systems throughout Douglas County, connecting with public lands and recreation facilities of local and regional interest	79
	6.1.3 Maintain and implement the <i>Douglas County Bicycle Plan</i>	79
7.0	AVIATION ELEMENT	80
7.1	Aviation Policies	81
	7.1.1 Provide for safe continuation and expansion of the Minden–Tahoe Airport	81
7.2	Aviation Goals	81



2017 Douglas County Transportation Plan

CONTENTS (Continued)

Chapter	Page
8.0 FINANCIAL ELEMENT	82
8.1 Funding for Road Maintenance	82
8.2 Financial Policies	83
8.2.1 Coordinate with the NDOT to implement capital and operational improvements on state facilities in a timely manner	83
8.2.2 Develop funding mechanisms to implement system-wide capacity and operational system improvements to the street and highway network	83
8.2.3 Develop funding mechanisms to maintain the existing street and highway network	83
8.2.4 Develop funding mechanisms to implement public transportation system improvements	83
8.2.5 Develop funding mechanisms to implement improvements to the bicycle/ pedestrian/trails system.	83
8.2.6 Develop funding mechanisms to implement improvements at the Minden–Tahoe Airport	83
8.2.7 Explore the development and implementation of a traffic impact fee program to fund regional capacity improvements on the street and highway network	83
8.2.8 Develop and maintain a coordinated transportation plan of proposed transportation facility improvements in collaboration with adjacent jurisdictions	83
8.2.9 Construct and maintain necessary street and road facilities in rural and urban settings to maintain a high quality-of-life in Douglas County	83
8.3 Funding for Proposed Transportation Projects	84
9.0 LAKE TAHOE ELEMENT	85
9.1 Lake Tahoe Transportation Policies	86
9.2 Lake Tahoe Transportation Actions	86
Appendix A: DOUGLAS COUNTY/CARSON CITY TRAVEL DEMAND MODEL	
Appendix B: V&T RAILROAD RIGHT-OF-WAY MAPS AND SELECTED PLAN SHEETS FROM THE CARSON & EAGLE VALLEY RAILROAD ROUTE ALIGNMENT CONCEPTS REPORT	
Appendix C: COMMENTS RECEIVED REGARDING THE DRAFT TRANSPORTATION PLAN AND FINAL DISPOSITION	
Appendix D: DOUGLAS COUNTY COMPLETE STREET POLICY STATEMENT	



2017 Douglas County Transportation Plan

FIGURES

Figure		Page
2.1	Lake Tahoe/Carson Valley/Carson City 2015 Housing Units	9
2.2	Lake Tahoe/Carson Valley/Carson City 2015 Occupied/Non-Occupied Housing Units	10
2.3	Lake Tahoe/Carson Valley/Carson City 2015 Employment	12
2.4	Douglas County Population Forecasts	13
2.5	Household Growth by Traffic Analysis Zone	18
2.6	Carson Valley Projected Employment Growth by Traffic Analysis Zone	19
2.7	Cumulative Frequency Distribution of Travel Time to Work	22
3.1	Douglas County and Carson City Traffic Analysis Zone Map	25
4.1	Roadway Functional Classification Map	28
4.2	Traffic Level of Service Illustration	36
4.3	Locations of U.S. 395 Safety Improvements Recommended as Near Term in the NDOT U.S. 395 Southern Sierra Corridor Study—2007	44
4.4	Existing Traffic Signals and Potential Future Roundabouts or Traffic Signals in the U.S. 395 Corridor	48
4.5	Map of Proposed Douglas County Transportation Projects—2017 to 2040	56
4.6	Topographic Map of the Carson Valley	57
4.7	Land Ownership and Private Conservation Areas	58
4.8	Map of Douglas County Emergency Access Routes with Primary Flood Zones	60
5.1	DART Service in Effect as of April 2016	63
5.2	DART Express Route Map	63
5.3	BlueGo Transit Map of Routes that Serve Douglas County and the Lake Tahoe Area	65
5.4	Potential Carson Valley/Lake Tahoe Gondola Route	73
5.5	Carson Valley Proposed Railroad Alignments	75



2017 Douglas County Transportation Plan

TABLES

Table	Page
2.1 Comparative Population Figures	7
2.2 Annual Building Permits Issued, Dwelling Units Constructed— 2000 to 2014	8
2.3 Employment by Industry	11
2.4 Douglas County Land Use/Employment Data Traffic Forecast Model— 2014 to 2040	14
2.5 Tentatively Approved Residential Subdivisions—Carson Valley, Topaz/Holbrook, and Tahoe Planning Areas (as of April 2016)	16
2.6 Approved Specific Plans—Carson Valley, Topaz/Holbrook and Tahoe Planning Areas (as of March 15, 2016)	17
2.7 Journey to Work Sorted by Workplace County for Douglas County and Carson City	20
2.8 Journey to Work Sorted by Residence County for Douglas County and Carson City	20
2.9 Means of Transportation to Work (workers 16 years and older)	21
2.10 Travel Time to Work (workers who did not work at home)	21
3.1 External Gateways in the Travel Demand Model	26
4.1 Douglas County Roadway Segment Traffic Volumes	31
4.2 Traffic Level of Service and Vehicle Volume to Capacity Ratio.....	33
4.3 Historic Traffic Levels at Select Locations (Average Daily Traffic)	35
4.4 Level of Service Definitions	36
4.5 Level of Service Threshold Volumes Comparison of Methodologies	37
4.6 Summary of U.S. 395 Safety Improvements Recommended as Near-Term in the NDOT <i>U.S. 395 Southern Sierra Corridor Study</i> —2007, not yet implemented	43
4.7 2025 LOS Deficiencies with Existing Roadway Network (no projects)	51
4.8 2040 LOS Deficiencies with Existing Roadway Network plus Mid-term Project #5 Heybourne Road.....	52
4.9 Proposed Transportation Projects—2017 to 2025 (Mid-term, Phase 1) Needed to Maintain LOS C on Douglas County Roadways and LOS D on NDOT Roadways	53



2017 Douglas County Transportation Plan

TABLES (Continued)

Table		Page
4.10	Proposed Transportation Projects—2026 to 2040 (Long-term, Phase 2) Needed to Maintain LOS C on Douglas County Roadways and LOS D on NDOT Highways	54
4.11	Proposed Transportation Projects—2017 to 2040 Projects for Alternate Local and Regional Access, Not Needed to Maintain LOS Standards	55
5.1	DART Express Schedule	64
5.2	BlueGo Transit Service Schedules of Routes that Serve Douglas County and the Lake Tahoe Area	66
5.3	Carson Valley Airporter Schedule	67
5.4	DART Measures of Effectiveness—FY 2014 to FY 2015	68
5.5	Carson Valley/Lake Tahoe Gondola Cost Estimate	72



2017 Douglas County Transportation Plan

EXECUTIVE SUMMARY

Douglas County is responsible for developing and maintaining a long-term regional transportation plan that coordinates implementation of transportation infrastructure and programs. The county prepared a transportation plan in 1993, which was revised in 1996 and again in 2007 as a part of the county's master plan update. In the interests of maintaining a plan that reflects the current conditions and future needs of the community, Douglas County officials contracted with Parsons in 2015 to assist county staff with updating the transportation plan.

Transportation trends indicate that between 2004 and 2011, vehicle miles traveled (VMT) in Douglas County decreased markedly—by 33.6 percent. From 2011 to 2013, VMT increased slightly by eight percent. According to the Federal Highway Administration (FHWA), these changes can be attributed somewhat to the changing economic situation in the United States. The 2008-2009 recession and prolonged recovery, which continues at the time of the writing of this report, contributed to the decline and then subsequent increase in VMT which continues to the current year. Douglas County population growth slowed considerably during the years 2000-2010, increasing by just 5,800 during those ten years. For this reason, county policymakers decided that the transportation plan update would analyze the need for proposed transportation projects based on population projections using a revised set of growth assumptions.

The *2017 Douglas County Transportation Plan* (the Plan) contains the complete list of goals and policies in Chapter 1, Introduction, with each subsequent chapter listing the goals and policies relevant to that chapter. The Plan identifies transportation improvement projects needed to maintain acceptable transportation levels of service by 2025 and 2040, as well as identifying projects recommended as safety improvements.

The *2017 Douglas County Transportation Plan* uses 2040 as the horizon year for planning purposes. As Douglas County continues to grow beyond that date, new transportation facilities will need to be planned and implemented to accommodate future growth.

Historic and Projected Growth

According to the U.S. Census Bureau, the 2010 Douglas County population was 46,997, an increase of 13.9 percent over the 2000 population of 41,259. This rate of growth is in the middle range of Nevada counties, substantially less than Clark County (41.8 percent), Lyon County (50.7 percent), Nye County (35.3 percent) and Washoe County (24.1 percent), and slightly more than White Pine County (9.3 percent).

Douglas County Community Development issued 4,502 residential building permits from 2000 through 2015. The majority of those permits were issued from 2000 through 2006. The number of permits dropped substantially after 2006. In the past few years the number of permits issued annually has begun to grow. The 2010 census shows an average of 2.39 persons per occupied dwelling unit. For the *2017 Douglas County Transportation Plan*, a 2040 population of 70,400 has been established for the purposes of travel demand forecasting. The 2040 population



2017 Douglas County Transportation Plan

projection reflects a 1.39 percent annually compounded growth rate over the State Demographer estimate of 48,478 for 2013.

Douglas County/Carson City Travel Demand Model

Transportation policy makers rely on travel analysis tools to evaluate the impacts of land use development and the need for infrastructure improvements. A travel demand model is one of the key technical analysis tools used for this evaluation. It uses a complex computer program to provide answers to “what if” questions about the effects of proposed development and land use policies. The model predicts travel behavior and travel demand within a specific area, over a particular time period.

A travel demand model uses a four-step process to create a simulation of current and future travel demands.

- Step 1. Trip generation (how many trips will people make?)
- Step 2. Trip distribution (where will people go?)
- Step 3. Mode choice (which methods will people use to travel?)
- Step 4. Trip assignment (what routes will people use?)

To provide a more accurate evaluation of travel patterns, the model encompasses transportation patterns in both Douglas County and Carson City. In addition to reflecting the regional nature of travel in these two counties, the shared model provides an opportunity to assist policy makers with coordinating proposed land use and transportation improvements.

Comparing the model results with actual traffic counts on the roadways indicates that the model was operating very accurately. This “model validation” took place using traffic counts at 69 locations in Douglas County and 103 locations in Carson City. These were a combination of 2014 Nevada Department of Transportation counts and 2015 counts by Parsons. The counts showed an overall total deviation between the travel model and the actual traffic counts of about three to eight percent (AM/PM, off peak and daily), which is within allowable tolerances for planning purposes as described in Appendix A, Douglas County/Carson City Travel Demand Model report.

In addition to validating the model for the base year 2015, Parsons ran the traffic model for the years 2025 and 2040 to determine the transportation system needs in the future. Based on the model results, completing the lists of proposed projects in Chapter 4 will allow Douglas County to maintain an acceptable traffic level of service (LOS) C at all of the critical locations on county roads for each of those planning years.

Streets and Highways Element

Chapter 4, the Streets and Highways section of the *2017 Douglas County Transportation Plan* discusses the existing and proposed future transportation network. This section explains the



2017 Douglas County Transportation Plan

methods used for quantifying the transportation network, such as traffic counts on Douglas County streets and highways, classification of streets into arterials, collectors and roadways; and methods for determining the traffic level of service. The section also discusses the major roadway issues in Douglas County, along with specific policies to maintain and improve the transportation network. Finally, this section includes two lists of capacity-improving projects; one for construction between 2017 and 2025, and another for construction between 2026 and 2040. Figure ES.1 provides a map of the Douglas County roadway network indicating the functional classification of the roads.

A significant transportation issue in Douglas County is the concern about traffic safety and capacity along the U.S. 395 corridor through the towns of Gardnerville and Minden. U.S. 395 is the primary corridor through Carson Valley, with a limited number of parallel roads that could absorb any through traffic. In addition, U.S. 395 transitions into historic Main Street through the towns of Gardnerville and Minden. The County and the towns all want a more pedestrian-friendly downtown.

Douglas County has grown slowly over the past 10 years. Although there are currently failures in the Level of Service on U.S. 395 between Minden and Carson City (LOS lower than level D), the existing County-maintained transportation infrastructure has been able to adequately cope with the effects of this growth, maintaining traffic flow with LOS C or better. The additional trips created by new development in both Douglas County and Carson City will add to existing traffic volumes, causing some additional roadway segments to fall below acceptable Levels of Service unless new transportation projects are constructed.

Public Transportation Element

Public transportation is an important part of the overall transportation system, providing mobility to residents who do not have access to private vehicle usage, such as low income persons, the elderly, and persons with disabilities. In addition to providing mobility within Douglas County, public transit allows residents to access regional employment, education and health care services located in the Carson City and Reno/Sparks area. Public transit also has the potential to reduce roadway congestion by reducing the number of vehicles on the road.

Douglas County operates the Douglas Area Rural Transit (DART) Dial-A-Ride service, which carries passengers between the southernmost and northernmost points of the county along the U.S. 395 corridor. It also operates DART Express, a fixed route with a fixed schedule serving the Minden-Gardnerville and Gardnerville Ranchos areas. Douglas County provides transit service in the Lake Tahoe area under a private contract. The BlueGo Bus Service operates along U.S. 50 from Zephyr Cove to Stateline and along the Kingsbury Grade. The Regional Transportation Commission of Washoe County funds and operates an intercity bus service between north Douglas County and the Meadowood Mall, the Reno/Tahoe Airport and downtown Reno.

Figure ES.1: Douglas County Roadway Network Functional Classifications

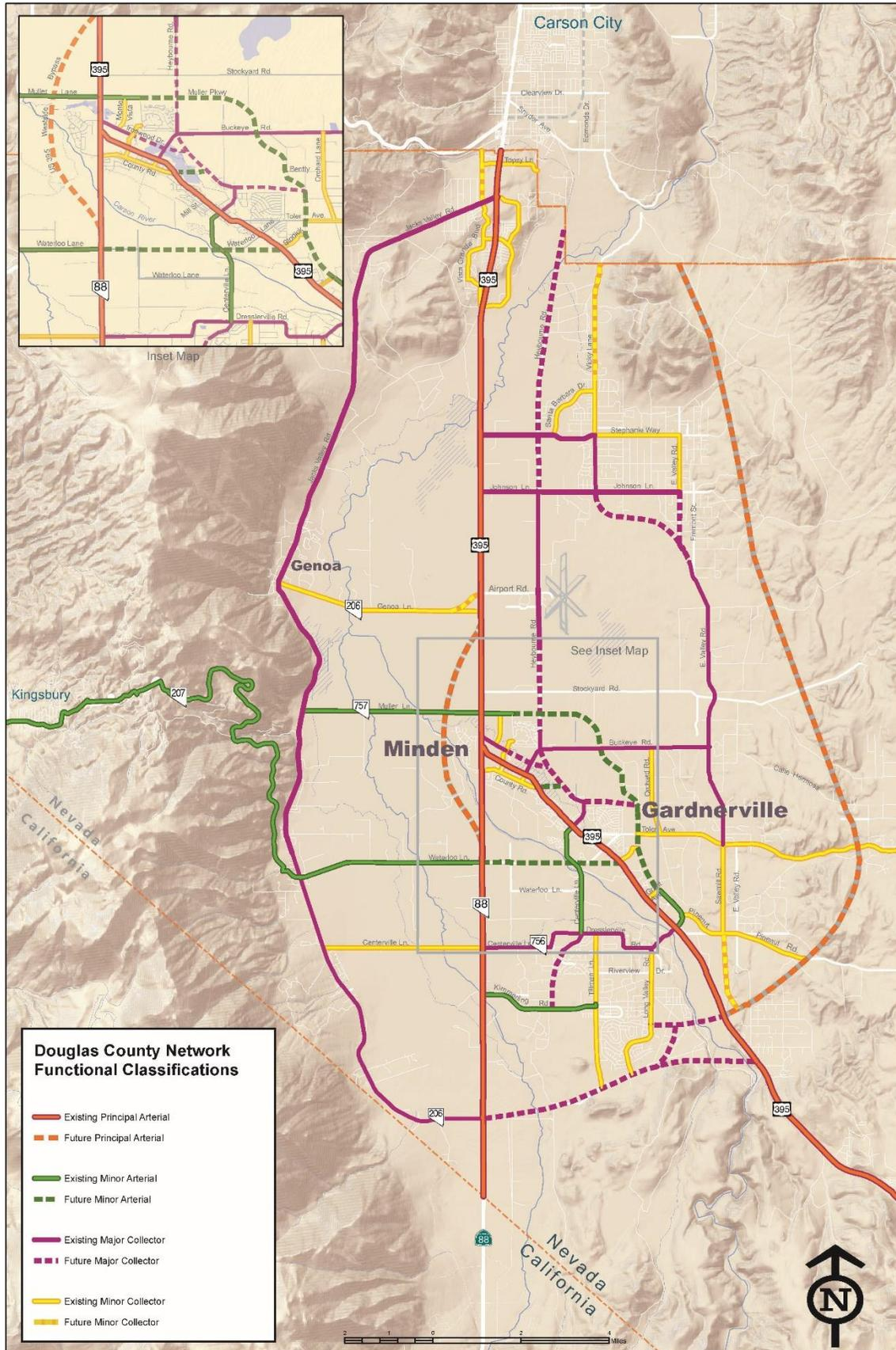



2017 Douglas County Transportation Plan

As Douglas County continues to focus growth in the Minden/Gardnerville area and along U.S. 395, residents will expect and need a more active transit service in this corridor. The estimated increase in population to 70,400 by 2040 will likely require the development of more frequent fixed route service and demand responsive service covering a wider geographical area. Increased tourist and employment activity in the Lake Tahoe and Carson Valley areas will also provide opportunities for increased use of public transportation in Douglas County.

This plan recommends that Douglas County prepare a short-range transit plan to determine the costs, benefits and logistics of improving local transit services. The proposed transit plan should include evaluation of the existing and future transit projects identified in the County's 5-Year Transportation Plan, and should consider expanded transit service hours, area and frequency of service, and compliance with the Americans with Disabilities Act.

Bicycle/Pedestrian/Trails Element

The *2003 Douglas County Bicycle/Pedestrian/Trails Plan* and the *2014 Douglas County Bicycle Plan* are separate documents that are incorporated by reference in their entirety into the *2017 Douglas County Transportation Plan*.

Aviation Element

The *2008 Minden–Tahoe Airport Plan* is a separate document, which is incorporated by reference in its entirety into the *2017 Douglas County Transportation Plan*.

Financial Element

The Financial Element lists the financial policies approved in the Transportation Element (Chapter 5) of the 2011 Master Plan. The discussion of funding options has been removed from this 2017 update to the Douglas County Transportation Plan.

Lake Tahoe Element

The *2007 Douglas County Transportation Plan* did not address the Lake Tahoe area, nor does this updated plan evaluate the need for projects within the Lake Tahoe Basin. Nevertheless, to provide for continuity with the Transportation Element (Chapter 5) of the 2011 Master Plan, and to provide a complete list of the Transportation policies in this document, the Lake Tahoe Element has been added to this 2017 plan which lists the policies and actions from the 2011 Master Plan relative to the Tahoe area. This element also references the planning agencies and planning documents for the area.



2017 Douglas County Transportation Plan

Chapter 1 INTRODUCTION

1.1 Overview

Douglas County is located in northern Nevada just south of the state capital, Carson City, and about 35 miles south of the state's third largest city, Reno. Containing 735 square miles of valley floor, rolling hills and steep mountains, Douglas County is less than 130 miles from the Sacramento metropolitan area and less than 220 miles from the San Francisco/San Jose metropolitan area. The rural character, excellent climate and beautiful scenery make Douglas County a desirable place to live.

The county has grown from a small, predominantly agricultural community in the 1960's to an urbanized population center today. Douglas County population grew most rapidly during the 1970's, experiencing steady growth until 2000. From 2000 to 2010, population growth in the county slowed significantly, increasing by just 5,800 during those ten years. The U.S. Census Bureau's estimated 2014 population figures indicate that Nevada is the second-fastest growing state in the nation, with a total population of 2.8 million people. Based on a 2013 population of 48,478 (State Demographer's estimate) and an increase of 1.39 percent per year (the historic growth rate identified in the 2011 Master Plan), compounded annually, the 2040 population of Douglas County will be approximately 70,400 persons.

Transportation trends reported by the Nevada Department of Transportation indicate that between 2004 and 2011, vehicle miles traveled (VMT) in Douglas County decreased markedly—by 33.6 percent. From 2011 to 2013, VMT increased slightly by eight percent. According to the Federal Highway Administration (FHWA), these changes can be attributed somewhat to the changing economic situation in the United States. The 2008–2009 recession and prolonged recovery, which continues at the time of the writing of this report, contributed to the decline and then subsequent increase in VMT which continues to the current year.

For this reason, county policymakers decided that the transportation plan update would analyze the need for proposed transportation projects based on revised population projections using an updated travel demand model.

The *2017 Douglas County Transportation Plan* contains the complete list of goals and policies in Chapter 1, Introduction, with each subsequent chapter listing the goals and policies relevant to that chapter.

1.2 Updating the 2007 Transportation Plan

Douglas County is responsible for developing and maintaining a long-term regional transportation plan that coordinates implementation of transportation infrastructure and programs. Douglas County prepared a transportation plan in 1993, which was revised in 1996



2017 Douglas County Transportation Plan

as a part of the county's master plan update. In 2005, county officials contracted with Parsons to update the transportation plan for 2007. Parsons has again been designated to update the Transportation Plan section of the Douglas County Master Plan for the year 2017.

The *2017 Douglas County Transportation Plan* update began in 2015 with the collection of traffic data on every arterial and collector in the Carson Valley. It continued with a roadway capacity analysis to determine the existing traffic level of service (LOS) on major arterial streets in Douglas County during morning and evening peak periods. Using U.S. census data, Douglas County tax parcel information, state provided employment records and land use information, Parsons updated the traffic demand model they developed in 2007 to simulate travel between traffic analysis zones. Using projections about future growth levels from the county's land use plans and information on approved projects, the travel model shows where people travel now and predicts where they will travel in the future.

Knowing where and when people will travel allows transportation planners to determine which transportation facility improvements are required to keep traffic flowing at an acceptable level of service, which is LOS C for Douglas County maintained roads, and LOS D for Nevada Department of Transportation roads. The Plan was then updated to identify of specific projects with timeframes for completion to maintain acceptable levels of service. By linking transportation improvements to areas of increasing population, Douglas County residents will continue to enjoy relatively free flowing traffic conditions.

The most recent version of the traffic model is based on land use decisions made by Douglas County officials and assumptions made by Douglas County staff. As land use decisions change and different projects are completed on different time schedules, county staff will be able to monitor population, employment and travel data. Future transportation plan updates will adjust the traffic model to reflect these changes. The travel forecast model also takes into account the existing and future traffic patterns of areas outside Douglas County. By examining the land use and traffic patterns of the adjacent governmental entities including Carson City, Washoe County and Lyon County, the Douglas County model more accurately reflects the current and future traffic conditions.

1.3 Goals and Policies of the Transportation Plan

The goals and policies represent the guiding principles of the transportation plan for Douglas County in the Carson Valley and Topaz planning areas. Goals, policies and objectives for the Lake Tahoe planning area are contained in the *Lake Tahoe Regional Plan*, prepared by the Tahoe Regional Planning Agency and approved in February 2013.



2017 Douglas County Transportation Plan

1.3.1 GOALS

The following are the overarching goals of the Transportation Plan:

- GOAL 1: Provide and maintain an integrated transportation system for the safe, efficient movement of people and goods throughout Douglas County.
- GOAL 2: Provide appropriate transportation facilities to ensure a high quality-of-life for Douglas County residents.

1.3.2 POLICIES

The following policies form the basis for implementation of the goals identified above. These policies are also identified in the chapters that follow.

Chapter 2: Historic and Projected Growth

- 2.3.1 Evaluate the impacts of current and planned development in Douglas County.
- 2.3.2 Coordinate transportation planning and land use development.

Chapter 3: Travel Demand Model

- 3.4.1 Update the travel demand model on a regular basis, at least every ten years.
- 3.4.2 Maintain accurate data on population, employment and average daily traffic to facilitate travel model update.

Chapter 4: Streets and Highways Element

- 4.2.1 Identify high accident locations and take appropriate actions to ensure continued public health and safety.
- 4.2.2 Provide appropriate traffic control devices on new and existing transportation facilities.
- 4.2.3 Protect public safety by removing snow and other hazards from roadways.
- 4.2.4 Post appropriate speed limits based on current speed limit studies.
- 4.2.5 Remove litter, trash and debris from the roadside and the right-of-way to keep roadways within Douglas County aesthetically pleasant.
- 4.2.6 Implement near-term traffic safety and traffic operations improvements from 2017 to 2020.
- 4.2.7 Implement mid-term road improvements to provide acceptable traffic operations from 2017 to 2025.
- 4.2.8 Implement long-term road improvements to provide capacity and mobility from 2025 to 2040.



2017 Douglas County Transportation Plan

- 4.2.9 Maintain a traffic level of service “D” on all NDOT roads within Douglas County, consistent with NDOT standards.
- 4.2.10 Develop a “pedestrian-friendly” U.S. 395/Main Street corridor through Minden and Gardnerville.
- 4.2.11 Support NDOT projects that maintain traffic flow (high speed and capacity) on U.S. 395 between Minden and Carson City, as identified in the U.S. 395 Southern Sierra Corridor Study (2007).
- 4.2.12 Support possible bypass facilities to keep traffic moving through Minden and Gardnerville.
- 4.2.13 Develop a truck routes plan to keep excessive through traffic out of neighborhoods.
- 4.2.14 Resolve/prevent neighborhood traffic issues by providing adequate through traffic facilities on major collectors and arterials.
- 4.2.15 Provide traffic transitional facilities (such as traffic circles/roundabouts) in the Minden/Gardnerville area.
- 4.2.16 Maintain a current map of proposed Douglas County transportation improvement projects.
- 4.2.17 Maintain current design standards for Douglas County roadway classifications as identified in the Douglas County Design Criteria and Improvements Standard Manual.
- 4.2.18 Maintain a level of service “C” or better on all Douglas County streets and roadways.
- 4.2.19 Provide transitional facilities between higher and lower classes of roadway functional types.

Chapter 5: Public Transportation Element

- 5.5.1 Provide general public transit service to Douglas County residents and visitors.
- 5.5.2 Provide transit services to the elderly and persons with disabilities, as required by the Americans with Disabilities Act (ADA).
- 5.5.3 Provide regional public transit, connecting Douglas County residents and visitors with Carson City, Washoe County and Alpine County (California).
- 5.5.4 Promote use of local and regional public transit serving Douglas County residents and visitors.
- 5.5.5 Develop public transit goals and objectives to measure and evaluate transit system performance.
- 5.5.6 Annually review performance measures and indicators for existing transit services and adjust services accordingly.



2017 Douglas County Transportation Plan

- 5.5.7 Prepare a short range transit plan, including a five-year transit project list, which identifies transit needs, and potential service improvements along with a financial plan.
- 5.5.8 Establish and preserve a transportation corridor in the vicinity of the former Virginia & Truckee Railroad right-of-way between Minden and the Carson City line, parallel to Heybourne Road.
- 5.5.9 Evaluate the feasibility of providing rubber-tire transit service to initially serve major travel destinations as development occurs along the Heybourne Road corridor. Identify potential private and public funding sources to establish and maintain service.

Chapter 6: Bicycle/Pedestrian/Trail Element

- 6.1.1 Maintain and implement the adopted Douglas County Comprehensive Trails Plan to provide opportunities for non-motorized transportation within the county that meets both recreational and commuter needs.
- 6.1.2 Ensure development and maintenance of multi-purpose (hiking, equestrian, bikeway and off-road bicycle) trail systems throughout Douglas County, connecting with public lands and recreational facilities of local and regional interest.
- 6.1.3 Maintain and implement the adopted Douglas County Bicycle Plan.

Chapter 7: Airport Element

- 7.1.1 Provide for safe continuation and expansion of the Minden–Tahoe Airport.

Chapter 8: Financial Element

- 8.1.1 Coordinate with the NDOT to implement capital and operational improvements on state facilities in a timely manner.
- 8.1.2 Develop funding mechanisms to implement system-wide capacity and operational system improvements to the street and highway network.
- 8.1.3 Develop funding mechanisms to maintain the existing street and highway network.
- 8.1.4 Develop funding mechanisms to implement public transportation system improvements.
- 8.1.5 Develop funding mechanisms to implement improvements to the bicycle/pedestrian/trails system.
- 8.1.6 Develop funding mechanisms to implement improvements at the Minden–Tahoe Airport.



2017 Douglas County Transportation Plan

- 8.1.7 Explore the development and implementation of a traffic impact fee program to fund regional capacity improvements on the street and highway network.
- 8.1.8 Develop and maintain a coordinated transportation plan of proposed transportation facility improvements in collaboration with adjacent jurisdictions.
- 8.1.9 Construct and maintain necessary street and road facilities in rural and urban settings to maintain a high quality-of-life in Douglas County. (See Complete Streets Policy dated January 19, 2016.)

Chapter 9: Lake Tahoe Element

LT Policy 1: Participate and support the planning, design and implementation of transportation projects and transit improvements at Lake Tahoe consistent with the Tahoe Revitalization initiative of the County Economic Vitality Plan and other needs identified through the annual update of the County 5-Year Transportation Plan, County Transportation Plan, and plans of the TRPA, TMPO and TTD.



2017 Douglas County Transportation Plan

Chapter 2 HISTORIC AND PROJECTED GROWTH

The *2017 Douglas County Transportation Plan* incorporates information about current land use development and the existing transportation network along with projections about future development and improvements. To develop this information, Parsons collected data from the U.S. Census Bureau, the Nevada State Demographer, and the Nevada Department of Employment, Training and Rehabilitation (DETR). The Plan uses 2040 as the horizon year for population forecasts and transportation project development.

2.1 Residential Capacity

According to the U.S. Census Bureau, the 2010 Douglas County population was 46,997, an increase of 13.9 percent over the 2000 population of 41,259. This rate of growth is in the middle range of Nevada counties, substantially less than Lyon County (50.7 percent), Clark County (41.8 percent), and Nye County (35.3 percent); and more than Elko County (7.8 percent) and Carson City (5.4 percent). Table 2.1 provides the comparative population figures for all Nevada counties from 2000 to 2010.

Table 2.1: Comparative Population Figures

STATE/COUNTY	2000 POPULATION*	2010 POPULATION**	PERCENT INCREASE (2000–2010)
State of Nevada	1,998,257	2,700,551	35.15%
Carson City	52,457	55,274	5.37%
Churchill County	23,982	24,877	3.73%
Clark County	1,375,765	1,951,269	41.83%
Douglas County	41,259	46,997	13.91%
Elko County	45,291	48,818	7.79%
Esmeralda County	971	783	-19.36%
Eureka County	1,651	1,987	20.35%
Humboldt County	16,106	16,528	2.62%
Lander County	5,794	5,775	-0.33%
Lincoln County	4,165	5,345	28.33%
Lyon County	34,501	51,980	50.66%
Mineral County	5,071	4,772	-5.90%
Nye County	32,485	43,946	35.28%
Pershing County	6,693	6,753	0.90%
Storey County	3,399	4,010	17.98%
Washoe County	339,486	421,407	24.13%
White Pine County	9,181	10,030	9.25%

Sources: * U.S. Census Bureau—April 1, 2000

** U.S. Census Bureau—April 1, 2010



2017 Douglas County Transportation Plan

As indicated above, the U.S. Census Bureau reported that the growth rate from 2000 to 2010 was 13.9 percent. This historic growth rate was also noted in the 2011 Douglas County Master Plan, Volume II, Chapter 2, Population. In 2013, the State Demographer’s Office projected that Douglas County’s population would grow at a rate of only 0.1 percent. Both estimates are below the 2.0 percent growth rate projected in the *2007 Douglas County Master Plan*.

During the 16-year period from 2000 to 2015, the County issued 4,502 single family residential building permits, 67 multi-family residential permits (for construction of 444 dwelling units), 13 duplex permits (26 dwelling units), and 178 mobile home permits. In total, 4,760 building permits were issued that resulted in the construction of 5,159 dwelling units, an average of 322 dwelling units per year during that time period. (Refer to Table 2.2.) The 2010 U.S. Census shows an average of 2.39 persons per occupied dwelling unit. Figure 2.1 summarizes the locations of existing housing in the Lake Tahoe/Carson Valley/Carson City area in 2015, while Figure 2.2 shows the split between occupied and non-occupied housing in the Carson Valley.

During the 10-year period from 2005 through 2014, overall employment within the County declined by approximately 18 percent. Of the ten industries identified in Table 2.3 *Employment by Industry*, only three had increases in employment during that time period. Those were professional and business services, education and health services, and other services. The local unemployment rate at the end of 2014 was 7.0 percent of the workforce. Figure 2.3 shows the employment locations in the Carson Valley.

Table 2.2: Annual Building Permits Issued, Dwelling Units Constructed—2000 to 2015

YEAR	SINGLE FAMILY RESIDENTIAL	MULTI-FAMILY RESIDENTIAL PERMITS (dwelling units)	DUPLEX PERMITS (dwelling units)	MOBILE	TOTAL ISSUED PERMITS (dwelling units)	DWELLING UNITS ALLOWED BY GROWTH ORDINANCE*
2000	542	4 (64)	0 (0)	29	575 (635)	N/A
2001	560	1 (9)	4 (8)	40	605 (617)	N/A
2002	672	0 (0)	2 (4)	37	711 (713)	N/A
2003	517	24 (104)	2 (4)	27	570 (652)	N/A
2004	505	10 (50)	2 (4)	19	536 (578)	N/A
2005	537	16 (74)	1 (2)	11	565 (624)	N/A
2006	418	0 (0)	1 (2)	4	423 (424)	N/A
2007	145	5 (77)	0 (0)	2	152 (224)	317
2008	48	3 (20)	0 (0)	1	52 (69)	323
2009	43	0 (0)	0 (0)	3	46 (46)	330
2010	35	2 (21)	0 (0)	1	38 (57)	336
2011	35	0 (0)	0 (0)	1	36 (36)	343
2012	49	0 (0)	0 (0)	0	49 (49)	350
2013	107	2 (34)	0 (0)	1	110 (142)	357
2014	151	0 (0)	0 (0)	0	151 (151)	364
2015	138	0 (0)	1 (2)	2	141 (142)	371
Total	4,502	67 (444)	13 (26)	178	4,760 (5,159)	N/A

Source: Douglas County Building Division (amounts figured by calendar year)

Note: Average number of dwelling units constructed each year between 2000 and 2015 is 322.

* The Growth Ordinance refers to Douglas County Title 20, Chapter 20.560

Figure 2.1: Lake Tahoe/Carson Valley/Carson City 2015 Housing Units

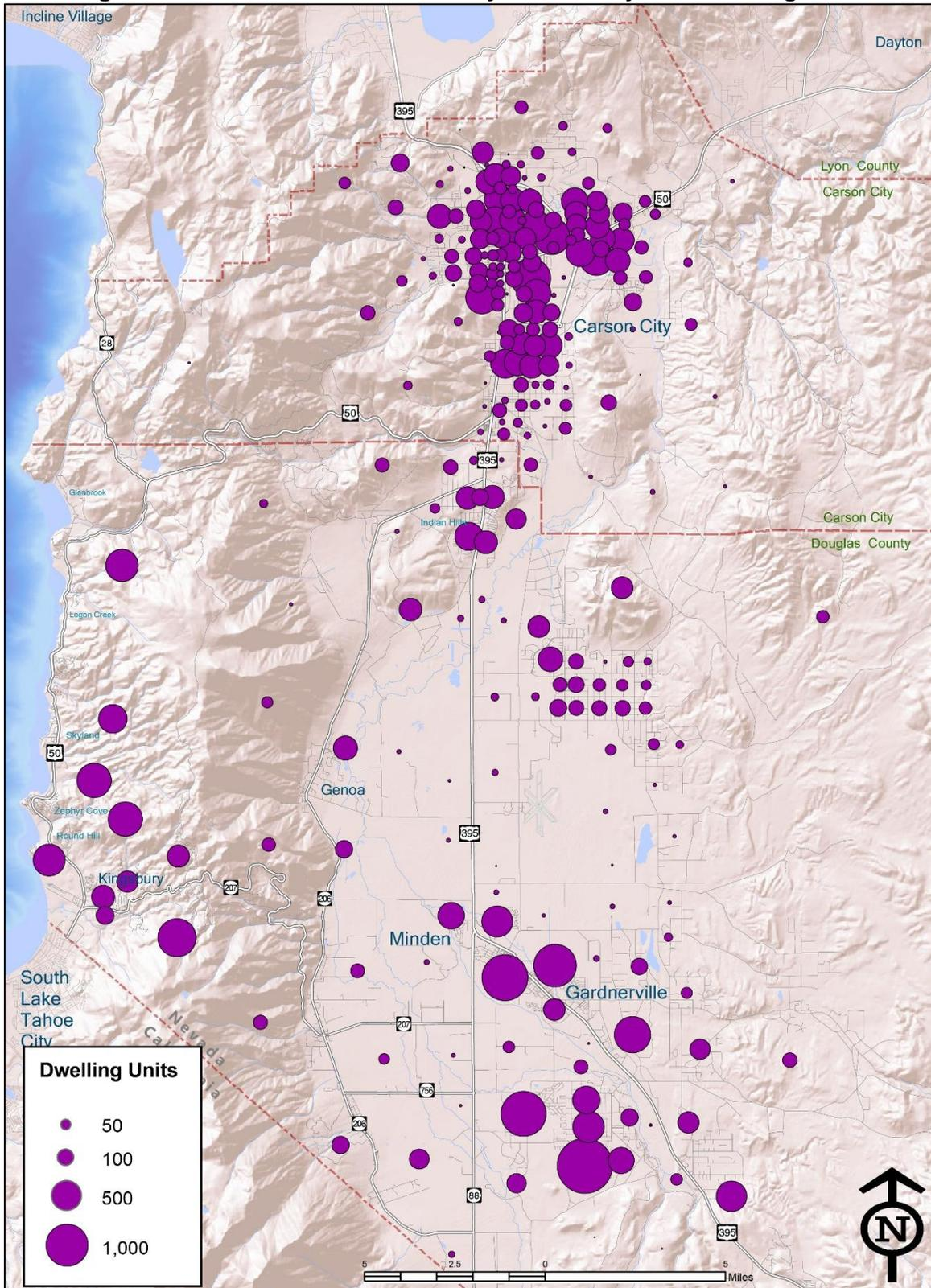

Source: 2010 U.S. Census data, City Building Permits

2017 Douglas County Transportation Plan

Figure 2.2: Lake Tahoe/Carson Valley/Carson City 2015 Occupied/Non-Occupied Housing Units

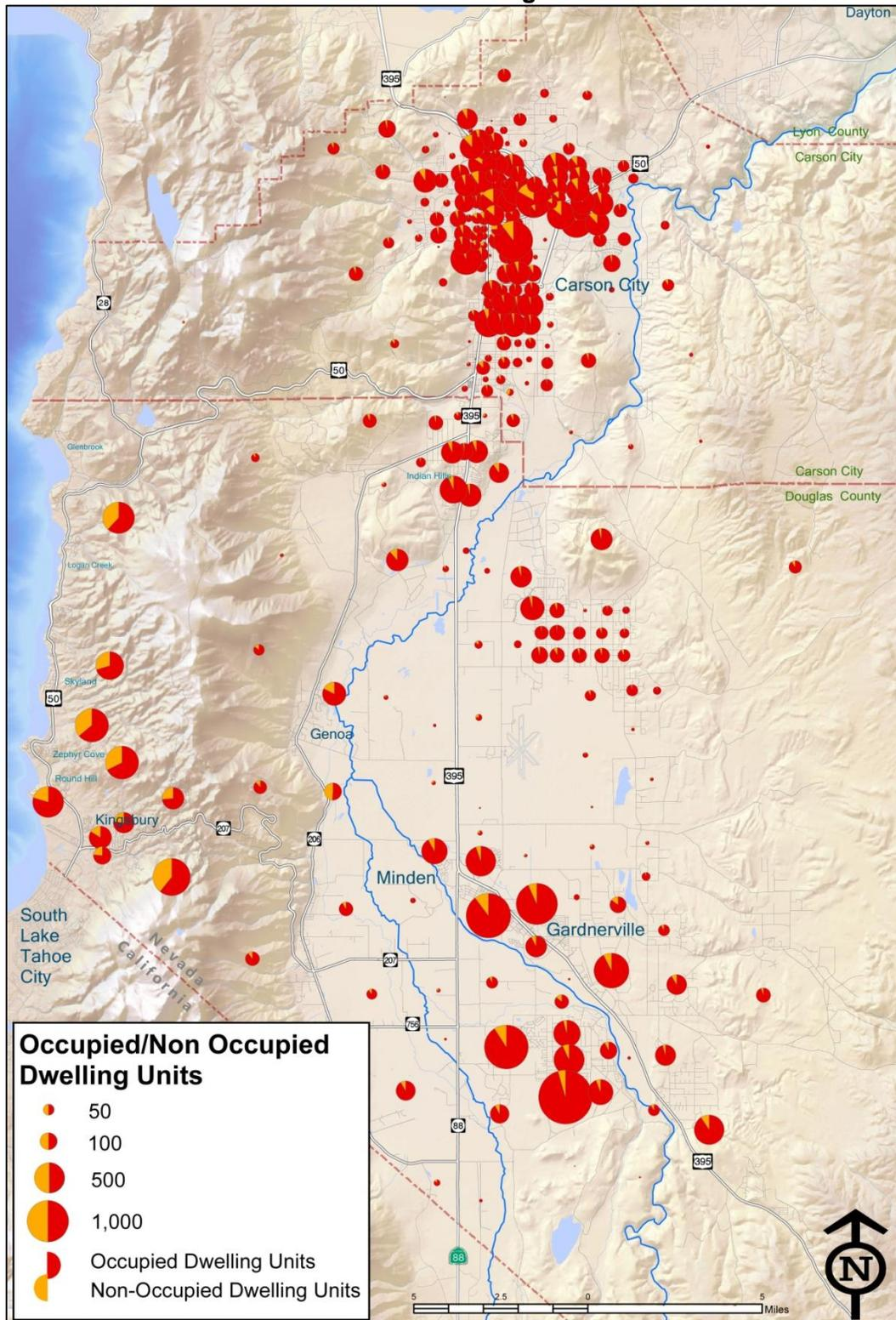



2017 Douglas County Transportation Plan

Table 2.3: Employment by Industry

INDUSTRY	2005	2006	2007	2008	2009	2010	2011	2012	2013	2014
Mining	185	175	161	149	137	138	134	137	135	132
Construction	2,038	2,092	1,903	1,423	1,015	775	768	752	808	991
Manufacturing	1,727	1,788	1,922	2,029	1,835	1,673	1,694	1,786	1,652	1,677
Trade, Transportation and Utilities	2,754	2,808	2,788	2,642	2,423	2,362	2,335	2,401	2,693	2,683
Information	206	231	204	169	142	135	131	125	127	139
Finance, Insurance and Real Estate	847	791	824	797	761	718	760	752	725	694
Professional and Business Services	1,533	1,688	1,672	1,636	1,480	1,501	1,499	1,453	1,593	1,596
Education and Health Services	1,019	1,120	1,165	1,216	1,249	1,246	1,296	1,352	1,416	1,444
Leisure and Hospitality	8,831	8,520	8,231	7,691	6,456	5,997	6,087	5,904	6,006	5,983
Other Services	364	369	354	369	342	342	351	365	400	400
Government	2,263	2,276	2,292	2,317	2,287	4,100*	2,204	2,158	2,208	2,215
Total	21,767	21,858	21,516	20,438	18,127	18,987	17,259	17,185	17,763	17,954

Source: State of Nevada Department of Employment, Training and Rehabilitation, 2016.

*Spike in government employment likely related to decadal hiring of temporary census workers.

2.2 Projected Growth

The United States Census Bureau (2000), projected that the rate of growth for the state of Nevada would be higher than any other state in the U.S. between 2000 and 2030. The Bureau projected that the state would gain 2,283,845 people by 2030, reaching a population of 4,282,102. This represents an increase of 114 percent during this 30-year period. The population of Nevada was 2,700,551 in 2010. The 2010 U.S. Census does not provide a projection for the year 2040. The process of selecting a population growth rate began by considering four potential growth rates. Those growth rates were:

- Very Slow Growth = 0.1 percent (from the State Demographer’s Office, 2013)
- Slow Growth = 1.0 percent (established by Douglas County)
- Historic Growth = 1.39 percent (2010 U.S. Census data and 2011 Master Plan)
- Maximum Growth = 2.0 percent (Douglas County Title 20, Chapter 20.560).

The Nevada State Demographer’s Office, in a report dated October 2013, established the 2013 Douglas County population as 48,478. Using this population as the starting point and the above growth rates, Figure 2.4 shows population projections for Douglas County up to 2040. The impacts of these four growth rates on the transportation network were then modeled using the projected 2040 populations and the existing roadway network. The model results were then reviewed with Douglas County Community Development staff, and the Historic Growth Rate of 1.39 percent was established as the rate to be used for all subsequent modeling.

Figure 2.3: Lake Tahoe/Carson Valley/Carson City 2015 Employment

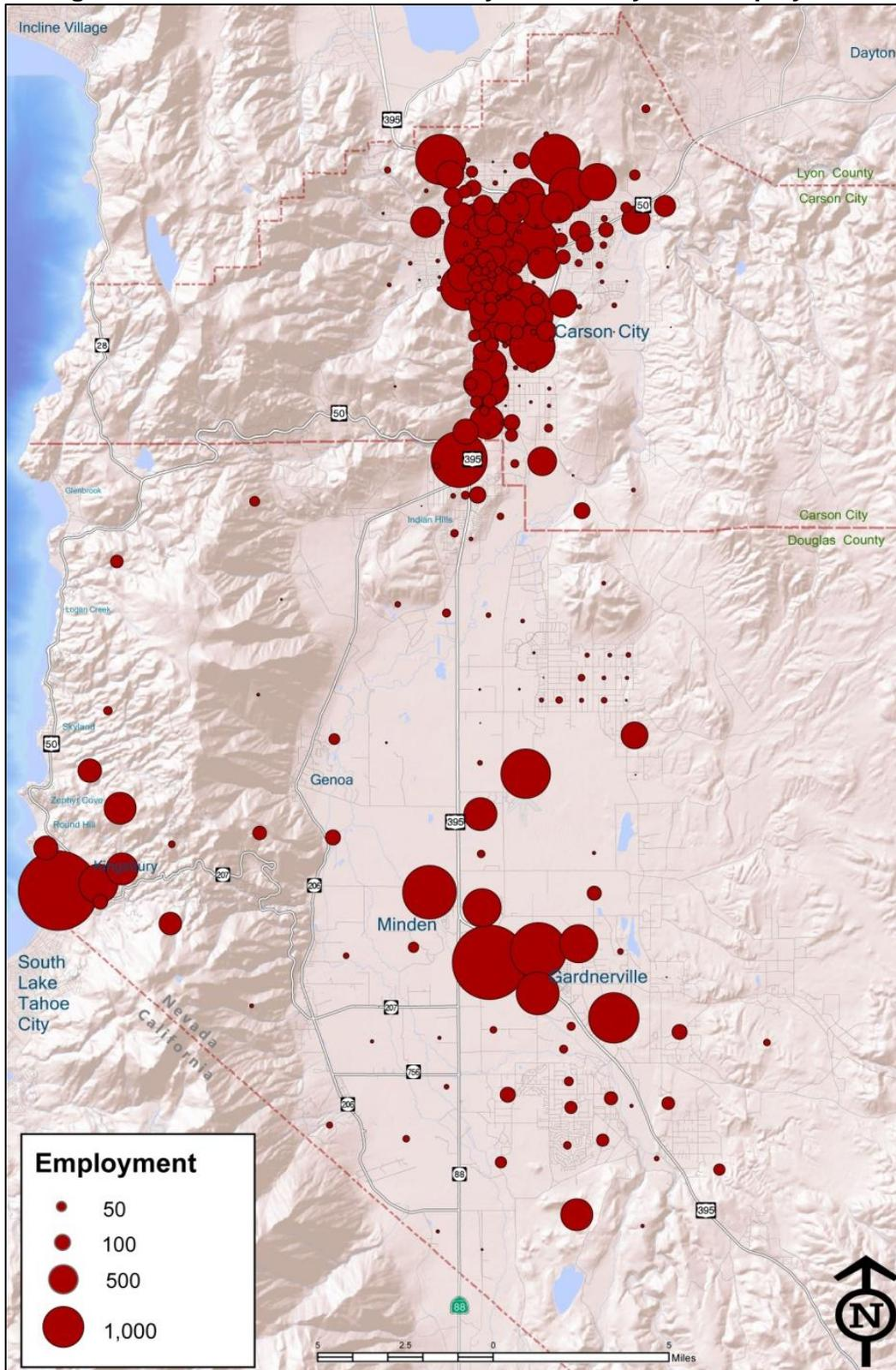

Source: 2014 Nevada Department of Employment, Training and Rehabilitation

2017 Douglas County Transportation Plan

Figure 2.4: Douglas County Population Forecasts

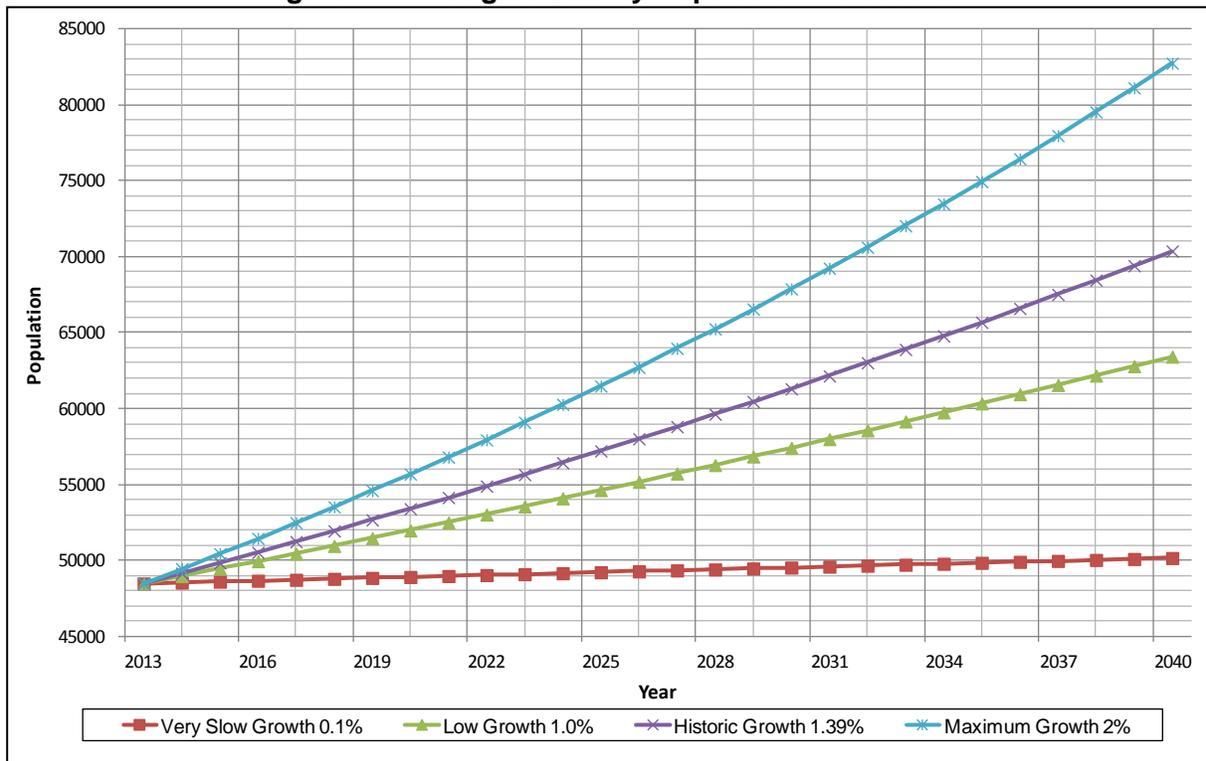

Source of the 2013 population of 48,478 is the Nevada State Demographer's report *Nevada County Population Projections 2014–2033*, dated October 1, 2014

Use of the Historic Growth Rate of 1.39 percent has a number of benefits compared to the previously used 2.0 percent growth rate:

- Based on past growth, it should approximate future growth more closely than the 2.0 percent growth rate used in 2007 Transportation Plan.
- It appears to be conservative in that it is higher than the rate experienced since 2010.
- For the 2040 scenario, it generates an estimated population of 70,400. This is slightly higher than the buildout population (66,803) identified in the 2011 Douglas County Master Plan Population and Housing–Technical Report based on maximum density associated with unimproved acreage. Accordingly, it anticipates that Master Plan amendments might be approved that would increase densities.

The 2040 population estimate of 70,400 is considerably lower than the estimate of 83,689 reflected in the 2007 Transportation Plan for the planning horizon year 2030. As a result, this 2017 Transportation Plan identifies fewer capacity improvement projects needed to maintain level of service standards than the 2007 Plan.

Douglas County voters approved the Sustainable Growth Initiative in November 2002, limiting the number of building permits that the county can issue to 280 per year. Implementation of



2017 Douglas County Transportation Plan

this ordinance was delayed due to legal actions at the State Supreme Court and District Court levels. In June 2007, the Douglas County Board of Commissioners approved a Growth Management Ordinance that revoked the initiative and established a two percent compounded growth rate for residential building permits over the next 50 years. The ordinance allows Douglas County to issue up to a maximum of 386 residential building permits in 2017 and up to 609 permits in 2040. However, the actual number of permits issued since the Growth Management Ordinance went into effect in 2007 has been well below the maximum allowed. Refer to Table 2.2, Annual Residential Permits Issued—2000 to 2015.

A travel forecast model is the tool commonly used to determine future traffic levels on the street system. For the purpose of the *2017 Douglas County Transportation Plan*, the travel forecast model developed for the 2007 Transportation Plan has been updated to reflect the current population, employment and highway network information for Carson City and Douglas County.

The updated travel forecast model includes both Douglas County and Carson City because these counties are connected geographically and economically. The residential and commercial growth in one area affects the growth and development of the adjacent area as people constantly travel between counties for housing, employment, health care and recreation. Table 2.4 shows the residential and employment data for 2014 and projections for 2040 that are used in the model. The table provides a summary of planning variables used in the model for the Douglas County portion of the two-county model.

Table 2.4: Douglas County Land Use/Employment Data Traffic Forecast Model—2014 to 2040

	DOUGLAS COUNTY LAND USE DATA					
	2014 MODEL*	2025 HISTORIC GROWTH**	2040 HISTORIC GROWTH**	2040 VERY SLOW GROWTH**	2040 LOW GROWTH**	2040 MAXIMUM GROWTH**
Population	46,931	57,214	70,376	50,161	63,419	82,747
Dwelling units	23,640	28,096	33,607	25,096	30,694	38,788
Occupied dwelling units	19,610	23,791	29,128	20,927	26,307	34,145
Total employment	19,761	24,608	30,812	21,281	27,533	36,644
Hotel employment	3,283	3,525	3,834	3,359	3,670	4,125
Office employment	3,953	5,675	7,880	4,493	6,715	9,952
Industrial employment	3,590	4,588	5,866	3,903	5,191	7,068
Retail employment	4,146	5,848	8,028	4,583	6,876	9,003
Retail shop employment	1,953	1,999	2,058	1,967	2,027	2,113
Commercial shop employment	1,593	2,535	3,741	1,888	3,104	4,874
Other retail employment	600	1,314	2,229	824	1,745	3,088
Non-retail employment	4,789	4,971	5,204	4,846	5,081	5,424
Elementary and middle school	5,144	6,271	7,714	5,497	6,951	9,070
High school enrollment	1,785	2,176	2,677	1,908	2,412	3,147
College enrollment	705	859	1,057	753	953	1,243

* Data from 2010 U.S. Census

** Growth rates applied to Nevada State Demographer 2013 data.



2017 Douglas County Transportation Plan

The Douglas County travel demand model reflects a 55.9 percent growth in employment from 2013 to 2040. Table 2.4 depicts employment by model category as the number of employees increase from 19,761 to 30,812. While the Nevada DETR reports an employment count of 17,954 non-farm jobs within Douglas County for 2014 (Table 2.3), 19,761 jobs were located geographically (based on the midpoint of employer specific count ranges), and assigned to a traffic analysis zone for traffic modeling purposes.

The following assumptions are included in the travel forecast model:

- Employment in Douglas County is expected to increase, in spite of the declining trend observed from 2005 to 2014.
- Population and employment growth has been distributed to traffic analysis zones based on the Master Plan land use designations in effect in 2015. Population growth has been distributed primarily to the receiving areas, while employment growth has been distributed to known areas of existing or planned employment.
- The travel model includes the housing developments approved by Douglas County and listed in Table 2.5 as projects with vesting for the administration of Building Permit Allocation and Growth Management Ordinance. The travel model also includes the future development associated with the North Douglas County Specific Plan identified in Table 2.6, Approved Specific Plans.

Most of the residential growth in the County is expected to be located in the Minden/Gardnerville area, generally bounded by Johnson Lane on the north, East Valley Road on the east, the Gardnerville Ranchos to the south, and SR 88 and U.S. 395 north of Buckeye Road on the west. Table 2.5 provides a list of tentatively approved subdivisions county-wide. The building permit allocations identified in the table are built into the travel demand model as future residential units for the years 2025 and 2040. These future units are reflected on Figure 2.5 which illustrates the projected residential growth in Carson Valley from 2010 to 2040.

Figure 2.6 illustrates the projected employment growth in Carson Valley from 2010 to 2040. The majority of the projected employment growth occurs in and around the Minden/Gardnerville area, including the area around the Minden–Tahoe Airport. A minor amount of new commercial development is projected for the area south of Gardnerville along U.S. 395. Additional commercial developments are planned for the northern most part of the county along U.S. 395.

2.3 Commute Patterns within Douglas County and Carson City

There is a fairly even balance between Douglas County in-commuting and out-commuting. The 2010 U.S. Census “Journey to Work” report data shows 7,528 commuters leaving Douglas County for work and 7,854 commuters coming into Douglas County for work. The largest numbers of out-commuters (4,394) travel to Carson City. The largest numbers of in-commuters (4,046) travel from El Dorado County, primarily to work for employers in the Lake Tahoe area.



2017 Douglas County Transportation Plan

Table 2.5: Tentatively Approved Residential Subdivisions—Carson Valley, Topaz//Holbrook, and Tahoe Planning Areas (as of May 2016)

PROJECT NAME	VESTED LOTS (Resolution #200R-082)	LOTS PLATTED THROUGH APRIL 2016	LOTS BUILT OUT	STATUS	VESTED ALLOCATIONS REMAINING	COMMUNITY
Rain Shadow (Aloha) Ranch (PD 04-002-1)	43	17	7	Partially expired	10	GV Ranchos
Anker Park/Ranch at Gardnerville (PD04-008-04)	633	71	70	Active	562	Minden/Gardnerville
Arbor Gardens (LDA 07-040)	160	160	160	Built-out	0	Minden/Gardnerville
Ashland Park (H&S) (PD 05-013)*	292	0	0	Expired	0	East Valley
Cedar Creek PD (PD 04-009) **	67	67	27	Active	40	GV Ranchos
Chichester Estates†	785	764	763	Active	1	Minden/Gardnerville
Clear Creek LLC (Master Plan approved 11/2003)	384	0	0	Active	384	Sierra
Eagle Ridge PD (PD 04-001)	58	55	6	Active	52	Genoa
Faiss (Sorensen Subdivision) (LDA 05-075)	7	7	7	Built-out	0	GV Ranchos
Finch Ranch (Serial TPM, LDA 04-088, -089)	14	14	1	Active	13	Fish Springs
Genoa Lakes PD	220	220	208	Active	12	Genoa
Grandview Estates PD‡	182	64	5	Active	59	East Valley
Huntsinger PD	5	5	1	Active	4	East Valley
James Canyon PD/Montana	395	217	138	Active	257	Genoa
Jilk (Saddlerock) (LDA 06-030, -070, -071)	7	7	0	Active	7	Ruhenstroth
Job's Peak Ranch PD	122	122	61	Active	61	Genoa
Kahn PD	6	0	0	Active	6	Topaz Lake
Kit Carson PD ***	59	59	11	Active	48	GV Ranchos
La Costa PD (NV Northwest) (PD 02-004)****	138	71	46	Active	25	Minden/Gardnerville
Landmark Communities PD (PD 04-007)*	31	0	0	Expired	0	Minden/Gardnerville
Mason (Morgan Meadows) (LDA 05-085)	9	9	4	Active	5	Indian Hills
Mica Dr. LLC (Cottages at Indian Hills) (PD 05-002)	48	24	0	Active	48	Indian Hills
Monterra PD (Park Place)*****	270	118	90	Active	28	Minden/Gardnerville
Mossdale PD (NV Northwest)*	37	0	0	Expired	0	Minden/Gardnerville
Nevada Northwest (Specific Plan adopted 11/1/2001)	303	0	0	Active	303	Minden/Gardnerville
Parkhaven (Armill)	21	0	0	Expired	0	Johnson Lane
Pleasantview (currently in Phase 7)	199	195	194	Active	1	GV Ranchos
Ranchos Sierra LLC PD (PD 05-009)*	302	0	0	Expired	0	GV Ranchos
Rocky Terrace Estates PD	90	90	55	Active	35	GV Ranchos
Sage Crest PD	13	13	0	Active	13	Johnson Lane
Saratoga Springs PD (Phase 8)	543	543	489	Active	54	Johnson Lane
SDB, LLC PD	8	8	0	Active	8	East Valley
Settelmeyer PD (PD 04-006)*	84	0	0	Expired	0	Ruhenstroth
Sikora*	10	0	0	Expired	0	GV Ranchos
Silveranch Estates	141	135	135	Active	6	GV Ranchos
Skyline Ranch§	132	131	130	Active	1	East Valley
Sterling Ranch Estates PD	32	32	30	Active	2	Gardnerville
Stodick Estates South PD	121	121	121	Built-out	0	Minden/Gardnerville
Stone Creek LLC*	72	0	0	Expired	0	GV Ranchos
Sunridge Heights III (currently in Phase 7)	278	278	272	Active	6	Indian Hills
Valley Vista I (currently in Phase 7)	261	225	225	Active	36	Indian Hills
Virginia Ranch (Specific Plan adopted 2/2/2004)	1,020	0	0	Active	1,020	Minden/Gardnerville
Totals	7,602	3,842	3,249		3,114	

Source: Douglas County Assessor/GIS Division/Community Development Department

Notes: PD = planned development; last recorded map phase is indicated in parentheses ()

*Expired projects. Available allocations have been changed to zero for projects that have expired.

**Does not include the clubhouse lot, which will require a building permit allocation.

***Excluding 140-unit Heritage NV senior housing project, which has expired.

****La Costa—71 of the 138 lots were recorded prior to expiration.

*****Monterra PD—118 lots were recorded prior to expiration.

†764 platted lots

‡Phase 2 expired; 64 vested allocations remain

§131 platted lots



2017 Douglas County Transportation Plan

Table 2.6: Approved Specific Plans—Carson Valley, Topaz/Holbrook and Tahoe Planning Areas (as of March 15, 2016)

SPECIFIC PLAN	COMMUNITY	ALLOWED NUMBER OF UNITS	MINUS UNITS/ LOTS RECORDED OR TENTATIVELY APPROVED	EXPIRED UNITS/ LOTS	TOTAL REMAINING UNITS/ LOTS TO RECORD
North Douglas County Specific Plan (adopted September 7, 2000)	Indian Hills	834	0	0	834
Corley Ranch Master Plan amendment (May 5, 2015)	Gardnerville	250	0	0	250
Total		1,084	0	0	1,084

Source: Douglas County Community Development Department

Carson City had 12,559 commuters enter from other counties, most significantly Douglas County (4,394), Lyon County (4,013) and Washoe County (3,576). There were 5,376 Carson City residents who left the county for work. Of these, 2,318 commuters went to Washoe County and 2,097 residents traveled to Douglas County.

Tables 2.7 and 2.8 provide a detailed breakdown of the commute patterns within Douglas County and Carson City as taken from the U.S. census data. These commute patterns indicate that a substantial amount of employment related travel occurs between Douglas County, Carson City and Washoe County. Due to the land use patterns and the limited number of parallel routes, much of this traffic is funneled through the U.S. 395 corridor.

U.S. census data within Douglas County and Carson City provide information on the mode of travel to work. Table 2.9 provides separate totals of modes of travel to work for Nevada, Douglas County, Carson City, and the two counties combined. The ratios of each transportation mode for the two counties are similar to the state averages in almost all categories. The main exception is the category of public transit, where Douglas County and Carson City average 0.8 percent use compared to the statewide average of 3.8 percent. The main users of the transit service in the study area are the elderly and persons with disabilities. Due to the rural nature of this area, transit service is not geared toward transporting working persons. Since the 2000 U.S. Census, Jump Around Carson has provided regular transit service in Carson City, which should increase the percentage of public transit use in the area.

Two interesting statistics emerge from Table 2.9: (1) 13 percent of the work trips involve a two-or-more person carpool and (2) 3.4 percent of the work trips are made by walking or bicycling. This data indicates that a significant number of commuters are already using alternatives to the single-occupant vehicle, with minimal marketing or external incentive.

Figure 2.5: Household Growth by Traffic Analysis Zone

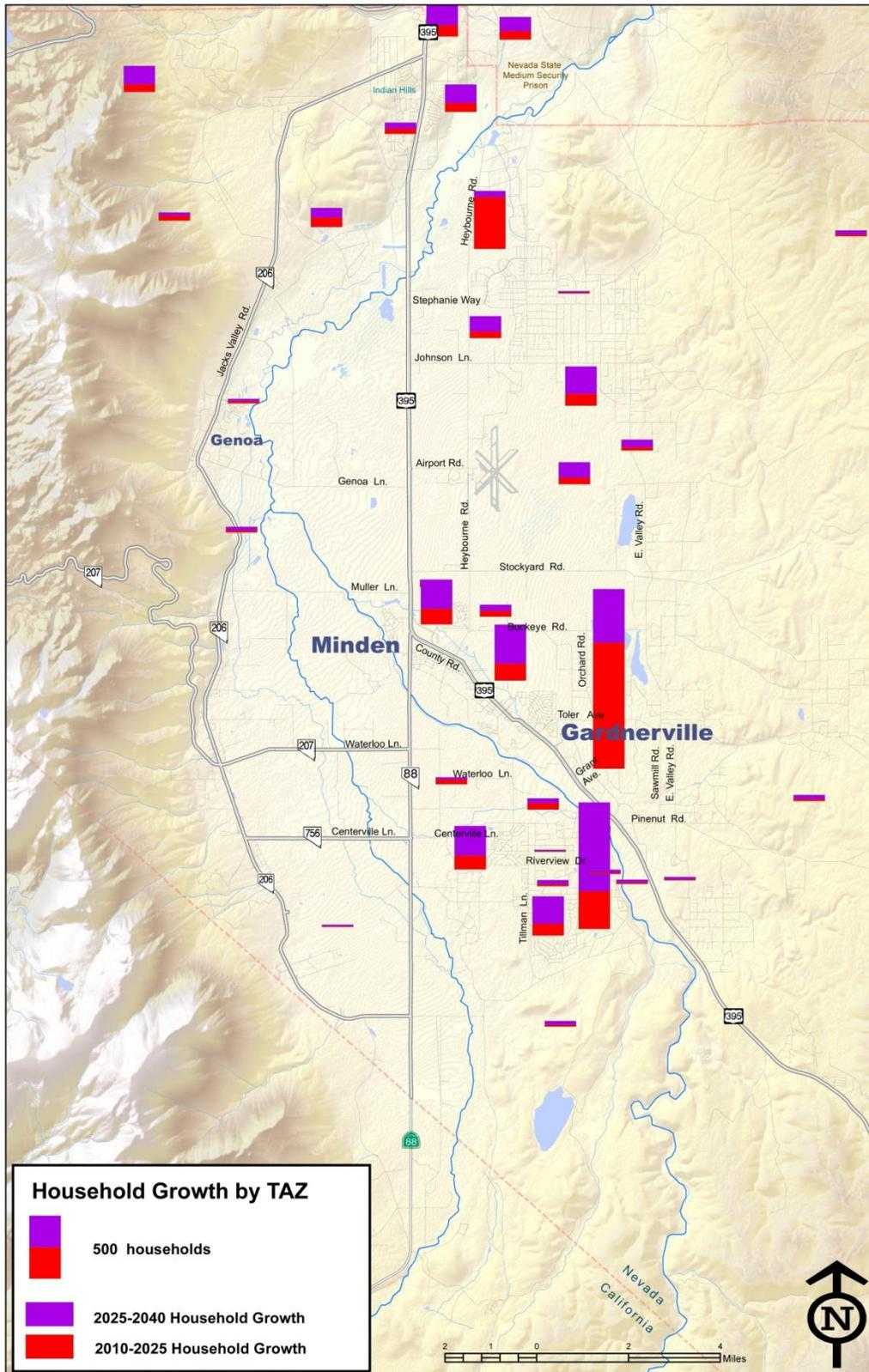
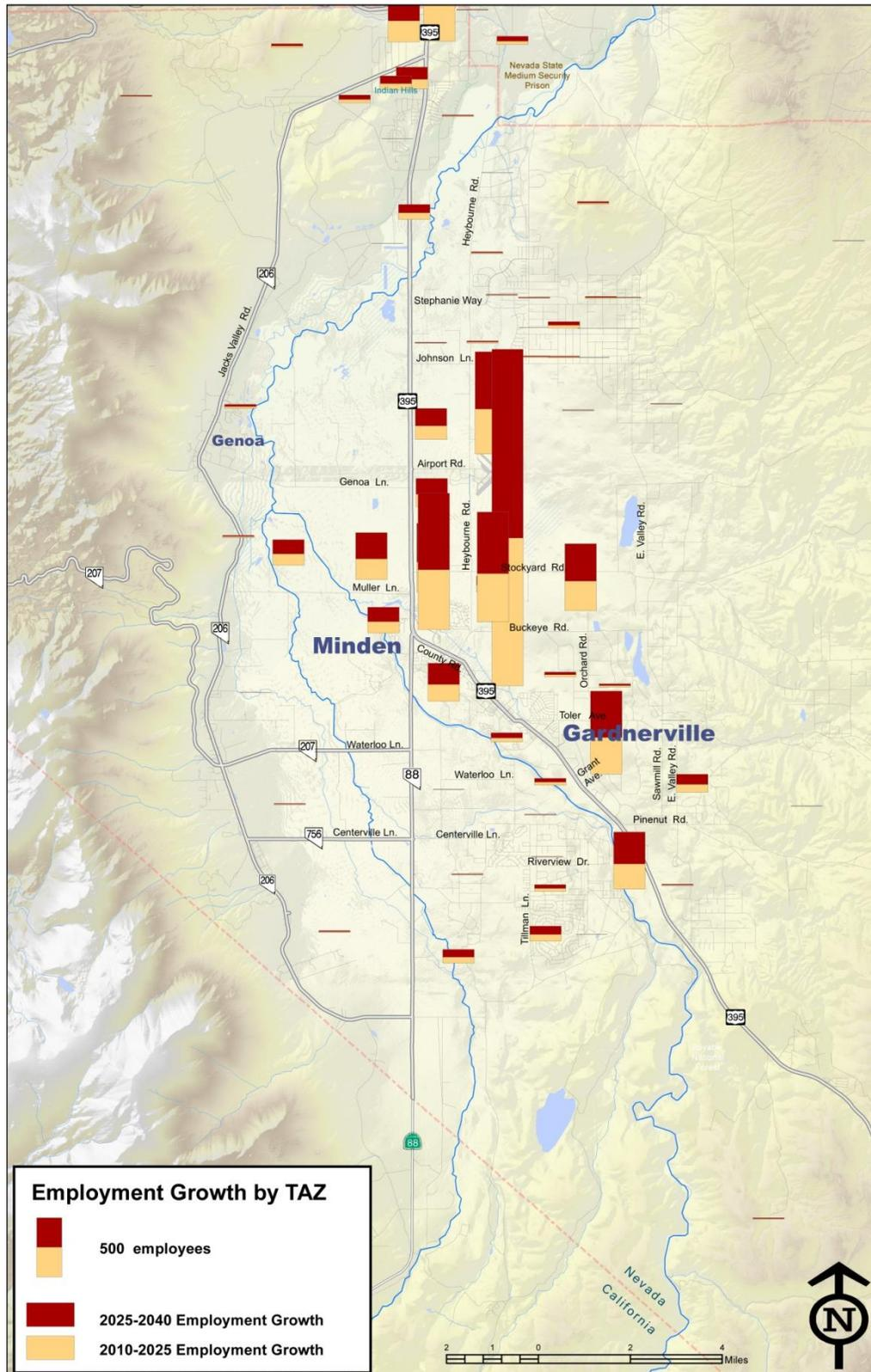

Figure 2.6 Carson Valley Projected Employment Growth by Traffic Analysis Zone





2017 Douglas County Transportation Plan

Table 2.7: Journey to Work Sorted by Workplace County for Douglas County and Carson City

RESIDENCE COUNTY	WORKPLACE COUNTY	COUNT
Total Douglas County Commuters		21,772
Douglas County, Nevada	Douglas County, Nevada	13,918
Commuters entering into Douglas County from other counties		7,854
*El Dorado County, California	Douglas County, Nevada	4,046
*Carson City, Nevada	Douglas County, Nevada	2,097
*Lyon County, Nevada	Douglas County, Nevada	652
*Washoe County, Nevada	Douglas County, Nevada	564
Commuters entering Douglas County from * areas		7,359
Commuters entering Douglas County from other areas		495
RESIDENCE COUNTY	WORKPLACE COUNTY	COUNT
Total Carson City Commuters		31,214
Carson City, Nevada	Carson City, Nevada	18,655
Commuters entering into Carson City from other counties		12,559
*Douglas County, Nevada	Carson City, Nevada	4,394
*Lyon County, Nevada	Carson City, Nevada	4,013
*Washoe County, Nevada	Carson City, Nevada	3,576
Commuters entering Carson City from * areas		11,983
Commuters entering Carson City from other areas		576

Source: 2010 U.S. Census

Table 2.8: Journey to Work Sorted by Residence County for Douglas County and Carson City

RESIDENCE COUNTY	WORKPLACE COUNTY	COUNT
Total Douglas County Commuters		21,446
Douglas County, Nevada	Douglas County, Nevada	13,918
Commuters leaving Douglas County to other counties		7,528
Douglas County, Nevada	*Carson City, Nevada	4,394
Douglas County, Nevada	*Washoe County, Nevada	1,058
Douglas County, Nevada	*El Dorado County, California	983
Commuters leaving Douglas County to * areas		6,435
Commuters leaving Douglas County to other areas		1,093
RESIDENCE COUNTY	WORKPLACE COUNTY	COUNT
Total Carson City Commuters		24,031
Carson City, Nevada	Carson City, Nevada	18,655
Commuters leaving Carson City to other counties		5,376
Carson City, Nevada	*Washoe County, Nevada	2,318
Carson City, Nevada	*Douglas County, Nevada	2,097
Carson City, Nevada	*Lyon County, Nevada	731
Commuters leaving Carson City to * areas		5,146
Commuters leaving Carson City to other areas		230

Source: 2010 U.S. Census



2017 Douglas County Transportation Plan

Table 2.9: Means of Transportation to Work (workers 16 years and older)

TRANSPORTATION MODE	NEVADA		DOUGLAS COUNTY		CARSON CITY		COMBINED CARSON CITY AND DOUGLAS COUNTY	
	Estimate	Percent	Estimate	Percent	Estimate	Percent	Estimate	Percent
Drove alone	700,085	74.4%	14,775	75.6%	22,410	79.2%	37,185	77.7%
2-person carpool	111,620	11.9%	2,125	10.9%	3,110	11.0%	5,235	10.9%
3-or-more-person carpool	28,660	3.0%	380	1.9%	670	2.4%	1,050	2.2%
Bus or trolley bus	35,645	3.8%	245	1.3%	125	0.4%	370	0.8%
All other transit	460	0.0%	10	0.1%	0	0.0%	10	0.0%
Bicycle or walked	30,205	3.2%	690	3.5%	920	3.3%	1,610	3.4%
Taxicab, motorcycle, or other mode	11,035	1.2%	175	0.9%	275	1.0%	450	0.9%
Worked at home	23,875	2.5%	1,150	5.9%	780	2.8%	1,930	4.0%
Totals	941,585	100%	19,550	100%	28,290	100%	47,840	100%

Source: 2000 U.S. Census – most recent data available as of 2016.

Table 2.10 provides detailed information on travel times to work within the state of Nevada, Douglas County and Carson City. The greatest share of commuters (25 percent) in the study area travel between 10 and 14 minutes to work, with most commuters (89 percent) traveling between 5 and 44 minutes. Figure 2.7 illustrates that Douglas County and Carson City share a similar commute pattern, with a 5 to 10 minute shorter commute than the statewide average, which is heavily influenced by Clark County travel patterns.

Chapter 3 provides a more extensive discussion of the travel forecast model and its use in developing the transportation system reflected in the Transportation Plan.

Table 2.10: Travel Time to Work (workers who did not work at home)

	NEVADA		DOUGLAS COUNTY		CARSON CITY	
	Estimate	Percent	Estimate	Percent	Estimate	Percent
Less than 5	24,695	2.7	1,105	6.0	1,060	3.9
5 to 9	89,890	9.8	2,520	13.7	4,985	18.1
10 to 14	139,740	15.2	4,355	23.7	7,085	25.8
15 to 19	169,305	18.4	3,295	17.9	4,245	15.4
20 to 29	235,470	25.7	2,930	15.9	3,935	14.3
30 to 44	168,750	18.4	2,510	13.6	3,725	13.5
45 to 59	39,075	4.3	750	4.1	1,345	4.9
60 or more	50,790	5.5	935	5.1	1,135	4.1
Mean travel time (minutes)	23.4	(X)	20.7	(X)	19.5	(X)
Median travel time (minutes)	20.2	(X)	15.4	(X)	15.2	(X)

Source: 2000 U.S. Census – most recent data available as of 2016.

Figure 2.7: Cumulative Frequency Distribution of Travel Time to Work

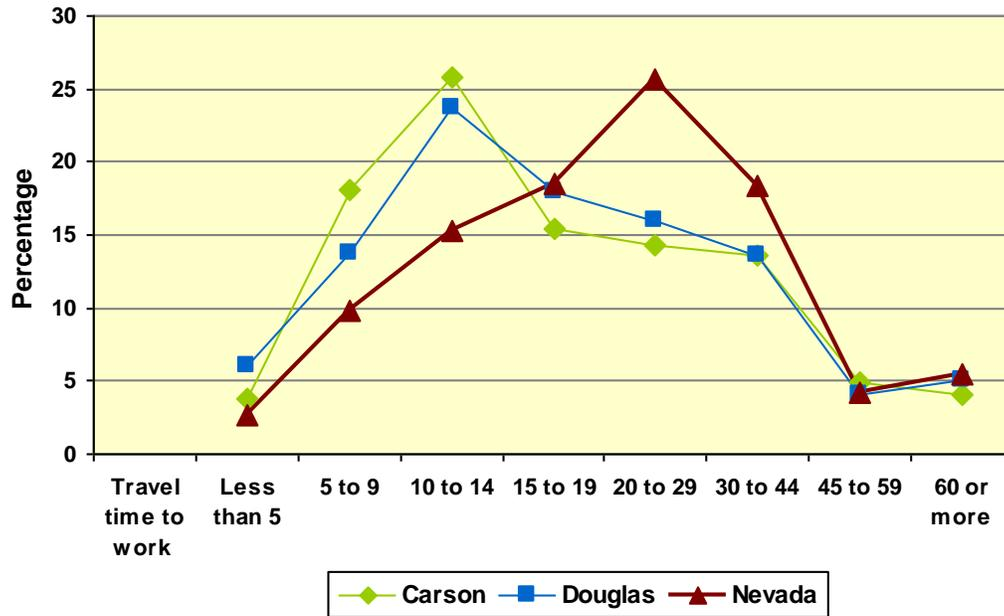

2.4 Growth Policies

- 2.4.1 Evaluate the impacts of current and planned development in Douglas County.
- 2.4.2 Coordinate transportation planning and land use development.

**Chapter 3****DOUGLAS COUNTY/CARSON CITY TRAVEL DEMAND MODEL**

Transportation policy makers rely on travel analysis tools to evaluate the impacts of land use development and the need for infrastructure improvements. A travel demand model is one of the key technical analysis tools used for this evaluation. It uses a complex computer program to provide answers to “what if” questions about the effects of proposed development and land use policies. The model predicts travel behavior and travel demand within a specific area, over a particular time period.

3.1 How Travel Demand Modeling Works

A travel demand model uses a four-step process to create a simulation of current and future travel demands.

- Step 1. Trip generation (how many trips will people make?)
- Step 2. Trip distribution (where will people start and end their trips?)
- Step 3. Mode choice (which methods will people use to travel?)
- Step 4. Trip assignment (what routes will people take?)

To account for land use development, the study area is broken into individual traffic analysis zones, which are assigned a specific number of origin and destination trips based on such factors as residential, employment and retail activities. Once the travel model is developed, transportation planners can create a simulation of existing travel patterns. The model is then checked or “validated” to ensure that the assumptions are correct. When the model is sufficiently calibrated to accurately account for current travel patterns, it can be used to forecast future travel based on proposed changes to the land use or infrastructure.

For example, when a new residential development is proposed, the model can predict the number of people who will travel on local and regional streets to reach their school, shopping, recreation and/or employment destinations. If a specific roadway is added to the existing network, or an existing road is widened, the model predicts how many trips will travel on the newly improved facility. In this way, transportation improvements can be designed and constructed to coordinate with the needs of the new development.



3.2 Overview of the Douglas County/Carson City Model

The Douglas County/Carson City travel demand model is designed to operate with TransCAD[®] software, which is used by the Nevada Department of Transportation (NDOT) for planning projects throughout the state. The detailed description of the modeling assumptions and analysis is available in a separate document, allowing Douglas County and NDOT model users to revise the model for future project analysis.

To provide a more accurate evaluation of travel patterns, the model encompasses transportation patterns in both Douglas County and Carson City. In addition to reflecting the regional nature of travel in these two counties, the shared model provides an opportunity for assisting policy makers with coordinating proposed land use and transportation improvements.

The travel demand model divides the two-county area into 324 internal traffic analysis zones and seven external traffic analysis zones for travel forecasting purposes. Figure 3.1 illustrates these boundaries on a map of the two counties. To increase model accuracy, traffic analysis zones that are located in urban areas have a smaller geographical area than those located in rural areas.

Some of the trips begin or end outside of the model area. These trips are assigned to locations where roads leave the county, called “external gateways.” Table 3.1 lists the locations of the external gateways used in the model.

The model identifies the streets and highways that people use for travel. Appendix A, the Travel Demand Model, Figure 3.1 shows the 2014 Base Highway Network with the streets identified according to their functional classification (see Chapter 4 for more detail on the classification system). This network contains all major streets in the study area and their characteristics, such as the number of lanes and the historical traffic counts. Because of the technical requirements of the travel demand model, this map shows a slightly different functional classification network than the Douglas County map.

3.3 Forecasting in the 2017 Douglas County Transportation Plan

The Douglas County/Carson City travel demand model is a new and improved version of the travel forecasting models and model components previously developed for Douglas County and Carson City. To develop an accurate database for the model development, staff obtained residential data from the Douglas County Assessor’s office and employment data from the Nevada Department of Employment, Training and Rehabilitation. Median income data was obtained from the 2000 census data at the block group level and was appropriately distributed at the traffic analysis zone level. All data was adjusted for the model base year 2014.

[®] TransCAD is a registered trademark of Caliper Corporation.

Figure 3.1: Douglas County and Carson City Traffic Analysis Zone Map

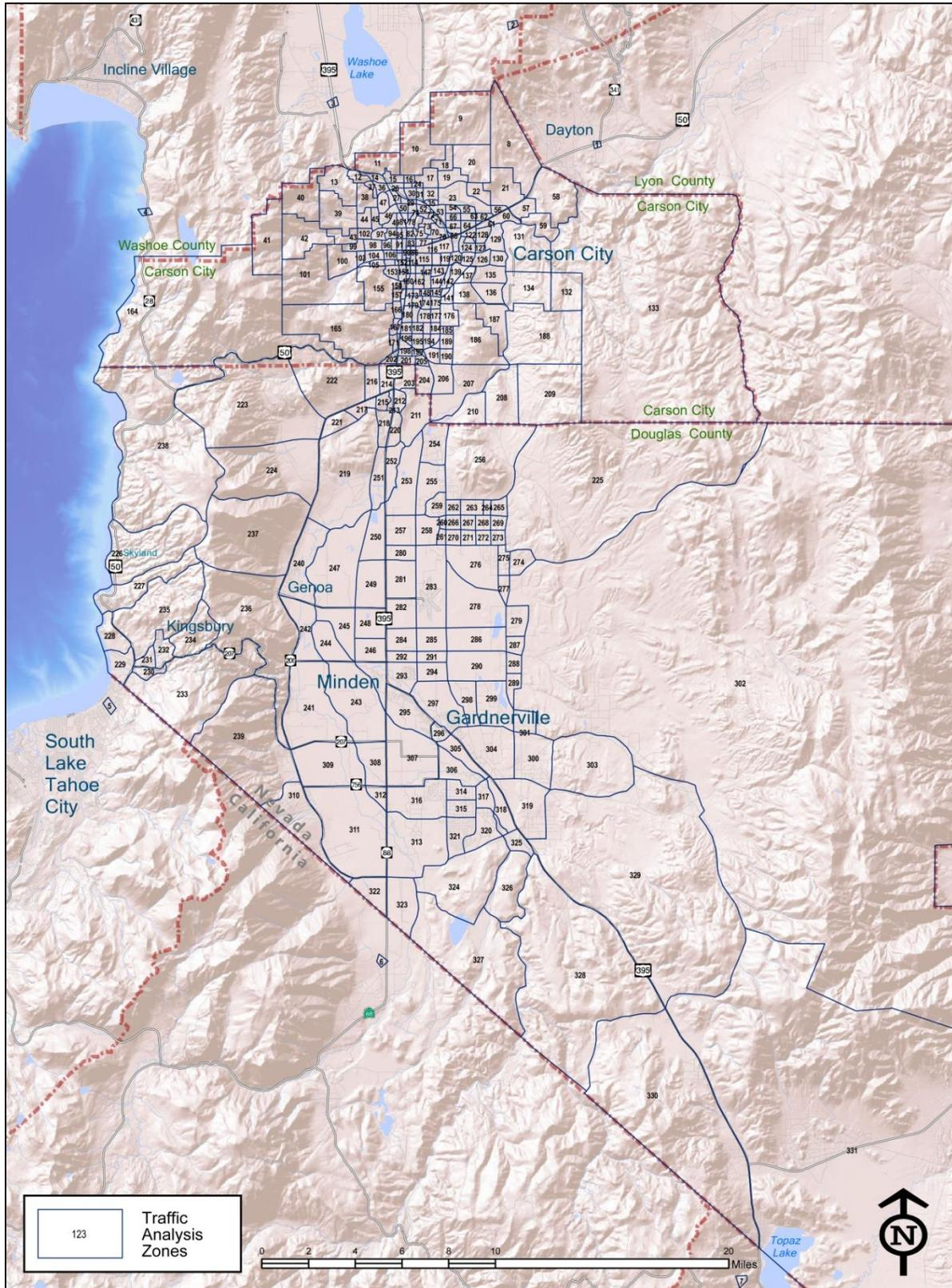



2017 Douglas County Transportation Plan

Table 3.1: External Gateways in the Travel Demand Model

GATEWAY/TAZ NO.	ROADWAY	LOCATION
1	U.S. 50	East end of Carson City
2	Goni Road	North end of Carson City
3	U.S. 395	North end of Carson City
4	State Route 28	West end of Carson City
5	U.S. 50	West end of Carson City
6	State Route 88	South end of Douglas County
7	U.S. 395	South end of Douglas County

Comparing the model results with actual traffic counts on the roadways indicated that the model was operating very accurately. This “model validation” took place using traffic counts at 69 locations in Douglas County and 103 locations in Carson City. The comparison was made for morning peak, evening peak, off-peak and daily traffic volumes. These were a combination of 2014 Nevada Department of Transportation counts and 2015 counts by Parsons. The counts showed an overall total deviation between the travel model and the actual traffic counts of three percent for morning peak travel, eight percent for evening peak travel, two percent for the off-peak travel and three percent for the daily travel. These variations are considered within allowable tolerances for planning purposes as described in Appendix A, Douglas County/Carson City Travel Demand Model report.

After validating the model for the base year 2014, Parsons ran the traffic model for the years 2025 and 2040 to determine the transportation system needs in the future. Please see Appendix A, *Douglas County/Carson City Travel Demand Model*, for a complete documentation of the travel demand model.

3.4 Travel Demand Model Policies

- 3.4.1 Update the travel demand on a regular basis, at least every ten years.
- 3.4.2 Maintain accurate data on population, employment and average daily traffic to facilitate travel model update.



2017 Douglas County Transportation Plan

Chapter 4 STREETS AND HIGHWAYS

The Streets and Highways section provides a detailed discussion of the existing and proposed transportation network. This section explains the methods used for quantifying the transportation network, including traffic counts on Douglas County streets and highways, classification of streets into arterials, collectors and roadways, and methods for determining the traffic level of service. The section also discusses the major roadway issues in Douglas County, along with specific policies to maintain and improve the transportation network. This section includes three lists of projects. These lists are sorted by timeframe and need: (a) projects needed by 2025 to maintain LOS C on County roads and LOS D on Nevada Department of Transportation (NDOT) roads, (b) projects needed by 2040 to maintain LOS C on County roads and LOS D on NDOT roads, and (c) projects that provide alternate local and regional access.

4.1 Assessment of Existing Conditions

4.1.1 FUNCTIONAL CLASSIFICATION

The first step in developing the transportation plan is to assess the condition of the existing street and highway network. Roadways are classified by the character of service they provide. Grouping types of roads based on their function allows for the development of road standards to meet travelers' mobility requirements. A brief discussion of the *Douglas County Engineering Design Criteria and Improvement Standards Manual* is included at the end of this section. A complete version of this document is available on the Douglas County website. To account for the technical requirements of the travel model, the roadway functional classification utilized in the model is slightly different from the highway network map shown on Figure 4.1. The following functional classification definitions are consistent with those adopted by the Nevada Department of Transportation (NDOT) in conformance with the United States Federal Aid Highway Law.

Principal Arterials

The rural principal arterial system consists of a connected rural network of continuous routes which serve corridor movements having trip lengths and travel density characteristics indicative of substantial state-wide or interstate travel. In addition, the rural principal arterial system serves essentially all urban areas with a population of 50,000 and over, and the majority of those with populations of 25,000 and over. The rural arterial system provides an integrated network without stub connections except where unusual geographic or traffic flow conditions dictate otherwise.

The rural principal arterial system is classified into the interstate system and other principal arterials. Within Douglas County, there are no roadways that are part of the interstate system, but there are several state highways that have been classified as other principal arterials. These roadways include U.S. 50, U.S. 395, State Route (SR) 28, SR 208, and SR 88. All of these roadways are maintained under the jurisdiction of NDOT.

Figure 4.1: Roadway Functional Classification Map

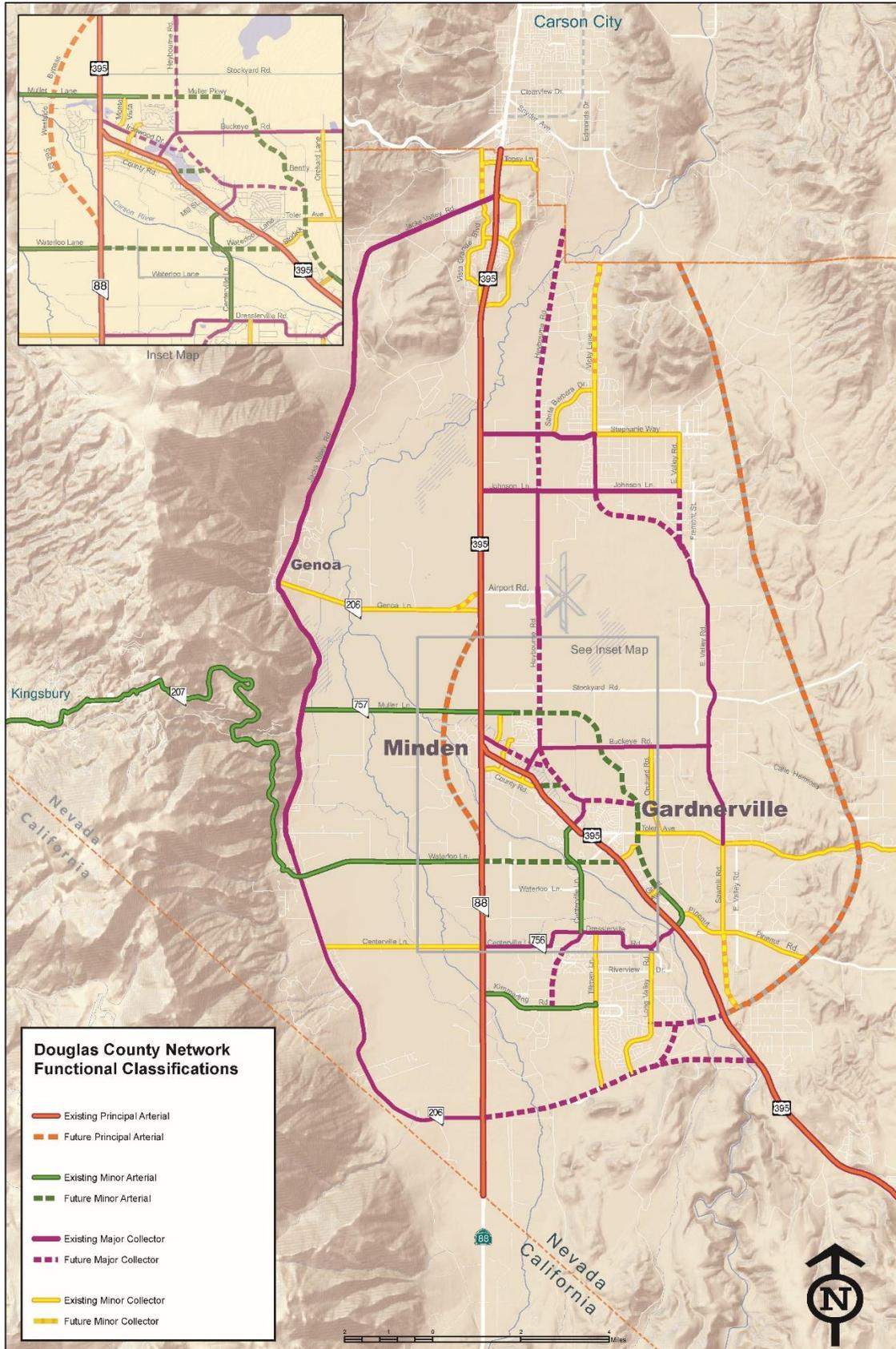



2017 Douglas County Transportation Plan

Minor Arterials

The minor arterial street system interconnects with and augments the principal arterial system and provides service to trips of moderate length at a somewhat lower level of travel ability than the principal arterials. In addition, this system distributes travel to geographic areas smaller than those identified within the principal arterial system. Minor arterial street systems include all arterials not classified as principal and contain facilities that place more emphasis on land access than the principal arterial system. Minor arterial systems typically carry local bus routes and provide inter-community continuity, but ideally do not penetrate identifiable neighborhoods. The minor arterial street system includes urban connections to rural collector roads where such connections have not been classified as principal arterials.

Rural/Urban Major Collector

The rural/urban major collector system provides service to any central business district not on an arterial route, and into the larger towns not directly served by higher systems. In addition, major collector roads provide service to traffic generators of equivalent intra-county importance such as consolidated schools, county parks, important mining areas, etc. The rural/urban major collector roads link these places with nearby larger towns or cities or with routes of higher classifications. Rural/urban major collector roads serve the more important intra-county travel corridors.

Rural/Urban Minor Collectors

The rural/urban minor collector roadways are laid out consistent with population density in order to collect traffic from local roads and bring all developed areas within a reasonable distance of the collector road. In addition, they provide service to the remaining smaller communities and link locally important traffic generators within their rural areas.

Rural/Urban Local Roadway

The local street system comprises all facilities not on one of the higher systems. The local roadway system provides direct access to abutting land and access to higher order systems.

Figure 4.1 shows the Roadway Functional Classification for streets and highways as determined by the Douglas County Community Development Department. Rural and urban local streets and roads are not illustrated on this graphic.

4.1.2 EXISTING TRAFFIC LEVELS

The second step in developing the transportation plan is to inventory the volume of traffic using the existing transportation network. To undertake this inventory, data was collected from NDOT and field counts were taken at 26 road segments in Douglas County and Carson City during 2015. These traffic volume counts were taken 24 hours per day for a period of seven days. Peak hour traffic counts were also taken at 10 intersections as directed by County staff.



2017 Douglas County Transportation Plan

Tables 4.1 and 4.2 provide a.m. and p.m. peak hour traffic data along certain Douglas County road segments. The tables allow for traffic flow in two possible directions: north-south **OR** east-west. When reading the tables, one must first determine the directional orientation of the road. On a north/south oriented road, the left column provides information for the northbound direction and the right column provides the southbound traffic data. On a roadway with an east/west orientation, the left column provides data for the eastbound traffic; the right column provides data for the westbound traffic.

Table 4.3 shows historical trends of average daily traffic on selected county roadways from 2005 to 2014. Traffic during this period has generally decreased, with traffic volumes at a few locations remaining nearly unchanged.

4.1.3 QUANTITATIVE EVALUATION/LEVEL OF SERVICE

Level of service (LOS) is the term used by traffic engineers to explain how effectively a roadway segment or intersection is operating as perceived by the transportation system user. Similar to the grading system used in schools where “A” is the best and “F” is the worst, the six traffic levels of service range from LOS A (high speed and high residual capacity with minimal delay) to LOS F (low speed and no residual capacity with high levels of delay). Figure 4.2 illustrates levels of service at an urban intersection and Table 4.4 describes the conditions experienced at different levels of service at signalized intersections.

Existing traffic levels of service for Douglas County’s streets and highways were determined by comparing daily traffic volumes to typical roadway capacities. The vehicle volume to roadway capacity compares roadway demand (vehicle volumes) with roadway supply (carrying capacity). This measure can alert transportation planners to areas where traffic mitigation measures should be considered. Volume to roadway capacity is often associated with determining the traffic level of service. While the levels of service may be estimated based on daily volumes and capacities, the ratings refer to peak hours of the day (typically morning and evening commute hours). During other hours, better levels of service would prevail.

Table 4.2 lists the traffic level of service and the vehicle volume-to-capacity ratio observed for the street segments which were counted for both morning and evening peak hours.

The roadway improvements described in this transportation plan are designed to maintain LOS C or better on all County-maintained roads, and LOS D or better on roads maintained by the Nevada Department of Transportation.



2017 Douglas County Transportation Plan

Table 4.1: Douglas County Roadway Segment Traffic Volumes

ROADWAY SEGMENTS	STATION NUMBER	AM PEAK HOUR		PM PEAK HOUR	
		North/East	South/West	North/East	South/West
Airport Road/SR 759–0.1 mile east of U.S. 395	50032	88	88	102	102
Buckeye Road east of U.S. 395	999999	238	266	283	345
Centerville Lane–175 feet east of Foothill Road	50062	74	74	92	92
Centerville Lane/SR 756–0.25 miles west of U.S. 395	50016	101	212	262	189
Centerville Lane/SR 756–550 feet east of SR 88	50018	114	160	228	151
County Road–300 feet east of SR 88	50064	119	119	167	167
Dresslerville Road–1,360 feet west of Tillman Lane	50074	98	98	130	130
Dresslerville Road–360 feet west of Tillman Lane	50075	199	199	292	292
Dump Road south of Pinenut Avenue	999999	72	82	76	70
East Valley Road–600 feet north of Pinenut Road	50051	31	31	41	41
East Valley Road north of Buckeye Road	999999	59	91	102	114
East Valley Road north of Fish Springs Road	999999	74	80	73	103
Fish Springs Road east of Valley Road	999999	61	103	114	66
Fish Springs Road west of Windmill Road	999999	24	43	45	31
Foothill Road/SR 206–0.1 mile north of Kingsbury Grade	50025	69	79	90	98
Foothill Road/SR 206–1.97 miles north of Muller Lane	50027	52	58	75	72
Foothill Road/SR 206–3.9 miles south of Centerville Lane	50022	27	12	11	22
Foothill Road/SR 207–775 feet south of Kingsbury Grade	50023	55	153	141	79
Fremont Avenue–0.5 miles south of Johnson Lane	50086	50	50	60	60
Genoa Lane/SR 206–400 feet west of U.S. 395	50028	47	50	43	70
Heybourne Road south of Johnson Lane	999999	79	69	50	91
Jacks Valley Rd–0.1 mile south of Alpine View Court	50048	61	61	66	66
Jacks Valley Rd–0.15 mile west of U.S. 395	50034	228	186	287	440
Jacks Valley Rd–0.4 miles north of Genoa Lane	50049	71	83	88	81
Johnson Lane–0.125 miles east of U.S. 395	50052	196	196	223	223
Kimmerling Road–150 feet east of Short Court	50066	171	171	264	264
Kimmerling Road east of Rubio	999999	177	494	453	221



2017 Douglas County Transportation Plan

Table 4.1: Douglas County Roadway Segment Traffic Volumes

ROADWAY SEGMENTS	STATION NUMBER	AM PEAK HOUR		PM PEAK HOUR	
		North/East	South/West	North/East	South/West
Kingsbury Grade/SR 207–0.3 miles west of Foothill Road	50024	254	177	171	310
Long Valley Road between Rancho Road and Watshemu Drive	50053	77	77	124	124
Long Valley Road south of Dresslerville	999999	264	224	257	467
Lucerne Street east of Ironwood Road	999999	114	148	105	131
Mica Drive west of U.S. 395	999999	120	142	140	183
Mottsville Lane–900 feet west of SR 88	50013	129	139	139	204
Muller Lane/SR 757–846 feet west of U.S. 395	50026	62	62	62	62
North Sunridge Drive–650 feet north of South Sunridge Drive	50084	27	27	39	39
Palomino Lane–0.123 miles east of U.S. 395	50071	32	32	43	43
Pinenut Road–0.5 miles east of U.S. 395	50050	71	71	86	86
Pinto Circle–255 feet north of Palomino Lane	50072	30	30	38	38
Plymouth Drive west of U.S. 395	999999	32	48	72	39
Riverview Drive–0.33 miles east of Dresslerville Road	50076	251	251	353	353
Stephanie Lane– 760 feet east of U.S. 395	50077	218	218	294	294
Stodick Lane east of U.S. 395	999999	64	104	120	87
Tillman Lane–500 feet north of Kimmerling Road	50073	81	81	220	220
Toler Avenue–150 feet east of Elges Avenue	50058	93	93	130	130
Toler Lane–1.3 miles east of Elges Avenue	50080	67	67	94	94
Vicki Lane–420 feet north of Johnson lane	50079	28	28	50	50
Vista Grande Boulevard west of Tourmaline Way	999999	139	80	116	176
Waterloo Lane–725 feet east of U.S. 395	50056	123	203	289	215
Waterloo Lane west of U.S. 395	999999	262	256	381	335
Zerolene Road east of U.S. 395	999999	8	8	11	15

Source: 2015 Parsons traffic counts (stations 999999) and 2014 Nevada Department of Transportation traffic counts

* ADT = average daily traffic



2017 Douglas County Transportation Plan

Table 4.2: Traffic Level of Service and Vehicle Volume to Capacity Ratio

ROADWAY SEGMENT	STATION NUMBER	AM PEAK HOUR				PM PEAK HOUR			
		North/East		South/West		North/East		South/West	
		LOS*	V/C**	LOS	V/C	LOS	V/C	LOS	V/C
Airport Road/SR 759–0.1 mile east of U.S. 395	50032	A	0.13	A	0.13	A	0.15	A	0.15
Buckeye Road east of U.S. 395	999999	A	0.34	A	0.38	A	0.4	A	0.49
Centerville Lane–175 feet east of Foothill Road	50062	A	0.09	A	0.09	A	0.12	A	0.12
Centerville Lane/SR 756–0.25 miles west of U.S. 395	50016	A	0.14	A	0.3	A	0.37	A	0.27
Centerville Lane/SR 756–550 feet east of SR 88	50018	A	0.16	A	0.23	A	0.33	A	0.22
County Road–300 feet east of SR 88	50064	A	0.2	A	0.2	A	0.28	A	0.28
Dresslerville Road–1,360 feet west of Tillman Lane	50074	A	0.14	A	0.14	A	0.19	A	0.19
Dresslerville Road–360 feet west of Tillman Lane	50075	A	0.28	A	0.28	A	0.42	A	0.42
Dump Road south of Pinenut Avenue	999999	A	0.1	A	0.12	A	0.11	A	0.1
East Valley Road–600 feet north of Pinenut Road	50051	A	0.04	A	0.04	A	0.05	A	0.05
East Valley Road north of Buckeye Road	999999	A	0.07	A	0.11	A	0.13	A	0.14
East Valley Road north of Fish Springs Road	999999	A	0.09	A	0.1	A	0.09	A	0.13
Fish Springs Road east of Valley Road	999999	A	0.08	A	0.13	A	0.14	A	0.08
Fish Springs Road west of Windmill Road	999999	A	0.03	A	0.05	A	0.06	A	0.04
Foothill Road/SR 206–0.1 mile north of Kingsbury Grade	50025	A	0.09	A	0.1	A	0.11	A	0.12
Foothill Road/SR 206–1.97 miles north of Muller Lane	50027	A	0.07	A	0.07	A	0.09	A	0.09
Foothill Road/SR 206–3.9 miles south of Centerville Lane	50022	A	0.03	A	0.02	A	0.01	A	0.03
Foothill Road/SR 207–775 feet south of Kingsbury Grade	50023	A	0.07	A	0.19	A	0.18	A	0.1
Fremont Avenue–0.5 miles south of Johnson Lane	50086	A	0.08	A	0.08	A	0.1	A	0.1
Genoa Lane/SR 206–400 feet west of U.S. 395	50028	A	0.07	A	0.07	A	0.06	A	0.1
Heybourne Road south of Johnson Lane	999999	A	0.1	A	0.09	A	0.06	A	0.11
Jacks Valley Road–0.1 mile south of Alpine View Court	50048	A	0.08	A	0.08	A	0.08	A	0.08
Jacks Valley Road–0.15 mile west of U.S. 395	50034	A	0.16	A	0.13	A	0.21	A	0.31
Jacks Valley Road–0.4 miles north of Genoa Lane	50049	A	0.09	A	0.1	A	0.11	A	0.1
Johnson Lane–0.125 miles east of U.S. 395	50052	A	0.28	A	0.28	A	0.32	A	0.32
Kimmerling Road–150 feet east of Short Court	50066	A	0.29	A	0.29	A	0.44	A	0.44



2017 Douglas County Transportation Plan

Table 4.2: Traffic Level of Service and Vehicle Volume to Capacity Ratio

ROADWAY SEGMENT	STATION NUMBER	AM PEAK HOUR				PM PEAK HOUR			
		North/East		South/West		North/East		South/West	
		LOS*	V/C**	LOS	V/C	LOS	V/C	LOS	V/C
Kimmerling Road east of Rubio	999999	A	0.3	D	0.82	C	0.76	A	0.37
Kingsbury Grade/SR 207–0.3 miles west of Foothill Road	50024	A	0.32	A	0.22	A	0.21	A	0.39
Long Valley Road between Rancho Road and Watshemu Drive	50053	A	0.13	A	0.13	A	0.21	A	0.21
Long Valley Road south of Dresslerville	999999	A	0.44	A	0.37	A	0.43	C	0.78
Lucerne Street east of Ironwood Road	999999	A	0.19	A	0.25	A	0.18	A	0.22
Mica Drive west of U.S. 395	999999	A	0.2	A	0.24	A	0.23	A	0.31
Mottsville Lane–900 feet west of SR 88	50013	A	0.18	A	0.2	A	0.2	A	0.29
Muller Lane/SR 757–846 feet west of U.S. 395	50026	A	0.09	A	0.09	A	0.09	A	0.09
North Sunridge Drive–650 feet north of South Sunridge Drive	50084	A	0.05	A	0.05	A	0.07	A	0.07
Palomino Lane–0.123 miles east of U.S. 395	50071	A	0.05	A	0.05	A	0.07	A	0.07
Pinenut Road–0.5 miles east of U.S. 395	50050	A	0.1	A	0.1	A	0.12	A	0.12
Pinto Circle–255 feet north of Palomino Lane	50072	A	0.05	A	0.05	A	0.06	A	0.06
Plymouth Drive west of U.S. 395	999999	A	0.05	A	0.08	A	0.12	A	0.07
Riverview Drive–0.33 miles east of Dresslerville Road	50076	A	0.36	A	0.36	A	0.5	A	0.5
Stephanie Lane–760 feet east of U.S. 395	50077	A	0.36	A	0.36	A	0.49	A	0.49
Stodick Lane east of U.S. 395	999999	A	0.11	A	0.17	A	0.2	A	0.15
Tillman Lane–500 feet north of Kimmerling Road	50073	A	0.14	A	0.14	A	0.37	A	0.37
Toler Avenue–150 feet east of Elges Avenue	50058	A	0.13	A	0.13	A	0.19	A	0.19
Toler Lane–1.3 miles east of Elges Avenue	50080	A	0.1	A	0.1	A	0.13	A	0.13
Vicki Lane–420 feet north of Johnson lane	50079	A	0.04	A	0.04	A	0.07	A	0.07
Vista Grande Boulevard west of Tourmaline Way	999999	A	0.23	A	0.13	A	0.19	A	0.29
Waterloo Lane–725 feet east of U.S. 395	50056	A	0.18	A	0.29	A	0.41	A	0.31
Waterloo Lane west of U.S. 395	999999	A	0.37	A	0.37	A	0.54	A	0.48
Zerolene Road east of U.S. 395	999999	A	0.01	A	0.01	A	0.02	A	0.03

Source: 2015 Parsons traffic counts (stations 999999) and 2014 Nevada Department of Transportation traffic counts

* LOS = level of service

** V/C = volume to capacity



2017 Douglas County Transportation Plan

Table 4.3: Historic Traffic Levels at Select Locations (Average Daily Traffic)

LOCATION	2005	2006	2007	2008	2009	2010	2011	2012	2013	2014
Airport Road—0.1 mile east of U.S. 395	2,700	2,550	3,000	2,500	2,600	2,300	2,500	2,200	2,200	2,200
Centerville Lane north of Dresslerville Road	8,800	8,850	8,700	8,500	8,500	8,300	8,200	8,000	7,400	7,500
Centerville Lane—175 feet east of Foothill Road	2,450	1,900	2,500	2,400	2,300	2,200	2,200	1,900	1,900	2,100
Centerville Lane—550 feet east of SR 88	4,300	4,250	4,200	3,900	3,800	4,000	3,800	4,000	3,900*	4,200
County Road—300 feet east of SR 88	3,150	3,100	4,100	3,700	3,600	3,700	3,500	3,100	3,400	3,200
Genoa Lane—400 feet south of U.S. 395	1,450	1,450	1,500	1,500	1,300	1,400	1,500*	1,300	1,100	1,500*
Jacks Valley Road—0.15 mile west of U.S. 395	11,000	11,100	10,000	9,400	8,600	8,500*	8,400	8,300*	8,600	8,300*
Johnson Lane—0.125 mile east of U.S. 395	7,250	7,250	6,600	5,700	5,900	5,100	4,600	5,000	5,200	5,200
Kimmerling Road—50 feet east of Short Court	7,300*	6,900*	6,600	6,200	6,200	5,700	5,900	5,600	5,600	5,600
Kingsbury Grade—0.3 mile west of Foothill Road	5,700	5,700	5,700*	5,700	5,100	5,000*	4,200	4,300	5,100	5,900
Kingsbury Grade—350 feet east of U.S. 50	14,600*	14,300*	13,000	14,000	13,000	14,000	14,000*	12,000*	12,000	12,000*
Mottsville Road—900 feet west of SR 88	4,050	4,050	4,100	4,600	4,300	4,000	4,000*	3,700	3,600	4,000
Muller Lane Parkway—846 feet west of U.S. 395	1,500*	1,650*	1,500	1,700	1,500	1,000	1,500	1,200	1,300	1,500
Pinenut Road—0.5 mile east of U.S. 395	3,300	3,250	3,600	3,300	3,000	2,600	2,500	2,000	2,300	2,500
SR 208—1 mile east of U.S. 395	4,100	4,150	4,000*	3,600	3,800	3,400	3,200	3,000	3,100	3,100*
SR 756 (Centerville)—0.25 mile west of U.S. 395	6,600	6,650	5,400	5,600	5,500	5,100	5,300*	5,200	4,900	5,300
SR 88—0.6 mile south of County Road	12,000	12,100*	13,000	12,000	12,000	11,000	11,000	11,000	11,000	11,000*
Toler Avenue—150 feet east of Elges Road	3,900	4,050	4,200	4,000	4,000	3,700	3,300	3,400	3,200	3,100
U.S. 395—0.25 mile south of Muller Lane Parkway	32,500	32,000	29,000	28,000	28,000	27,000	26,000*	26,000*	27,000	28,000
U.S. 395—0.4 mile north of Jacks Valley Road	45,500	46,000	44,000*	41,000	40,000	38,000	37,000	36,000*	36,000*	38,500
U.S. 395—700 feet south of SR 88	27,700	25,900	26,000	24,000	24,000	24,000	23,000*	23,000*	22,000	21,500
U.S. 50—300 feet east of SR 207	27,700	23,700	20,000	20,000	21,000	22,000*	24,000	21,000	22,000	25,000
Waterloo Lane—0.275 mile east of SR 88	2,200	2,250	2,100	2,100	2,000	1,900	1,700	1,400	1,400	1,800
Waterloo Lane—725 feet east of U.S. 395	6,900	7,400	7,200	7,200	7,400	6,600	6,400	5,900	5,800	5,600

Source: Nevada Department of Transportation

* Data adjusted or estimated.

2017 Douglas County Transportation Plan

Figure 4.2: Traffic Level of Service Illustration



Source: City of San Jose

Table 4.4: Level of Service Definitions

LOS	SIGNALIZED INTERSECTION	UNSIGNALIZED INTERSECTION	ROADWAY (DAILY)
A	Uncongested operations; all queues clear in a single signal cycle. <i>Average Delay < 5 sec</i>	Little or no delay. 0 to 4 second average delay	Free flow
B	Uncongested operations; all queues clear in a single cycle. <i>Average Delay 5 < 15 sec</i>	Short traffic delays. 5 to 9 second average delay	Free flow, presence of other vehicles noticeable.
C	Light congestion, occasional backups on critical approaches. <i>Average Delay 15 < 25 sec</i>	Average traffic delays. 10 to 19 seconds average delay	Ability to maneuver and select operating speed affected.
D	Significant congestions of critical approaches, but intersection functional. Cars must wait more than one cycle during short peaks. No long queues formed. <i>Average Delay 25 < 40 sec</i>	Long traffic delays. 20 to 29 seconds average delay	Unstable flow, speeds and ability to maneuver restricted.
E	Severe congestion; long queues on critical approaches. Blockage of intersection if no protected turning movements. Traffic queue may block nearby intersections upstream of critical approaches. <i>Average Delay 40 < 60 sec</i>	Very long traffic delays, failure, extreme congestion. More than 30 seconds average delay	At or near capacity, flow quite unstable.
F	Total breakdown, stop-and-go operation. <i>Average Delay > 60 sec</i>	Intersection blocked by external causes.	Forced flow, breakdown.

Source: 2010 Highway Capacity Manual



2017 Douglas County Transportation Plan

Table 4.5 compares Douglas County’s threshold volumes for LOS A through LOS E with the Florida Department of Transportation, a widely used reference, and Parsons’ standard for rural areas that are transitioning into urban areas. This table is used to evaluate the future level of service on roadways with different functional classifications. Generally, the Douglas County threshold is a slightly lower number than the other standards, resulting in facilities being rated at a lower level of service than similar facilities in other areas with the same traffic volume. This differential is only minor, indicating that Douglas County’s level of service threshold volumes are appropriate for this area.

Table 4.5: Level of Service Threshold Volumes Comparison of Methodologies

ROADWAY TYPE		MAXIMUM TOTAL DAILY VEHICLES IN BOTH DIRECTIONS (ADT)				
		A	B	C	D	E
6-lane freeway	Parsons	67,500	78,750	90,000	101,250	112,500
	Florida DOT*	NA	65,100	85,600	102,200	111,000
	Douglas County	NA	NA	NA	NA	NA
	2014 Thresholds	67,500	78,750	90,000	101,250	112,500
4-lane freeway	Parsons	45,000	52,500	60,000	67,500	75,000
	Florida DOT	NA	44,100	57,600	68,900	71,700
	Douglas County	NA	NA	NA	NA	NA
	2014 Thresholds	45,000	52,500	60,000	67,500	75,000
4-lane expressway	Parsons	28,800	33,600	38,400	43,200	48,000
	Florida DOT**	NA	35,300	49,600	62,900	69,600
	Douglas County	NA	NA	NA	NA	NA
	2014 Thresholds	28,800	33,600	38,400	43,200	48,000
6-lane major arterial	Parsons	36,000	42,000	48,000	54,000	60,000
	Florida DOT†	NA	NA	52,100	53,500	NA
	Douglas County	NA	NA	36,000	43,200	48,000
	2014 Thresholds	28,000	32,000	36,000	43,200	48,000
4-lane major arterial	Parsons	24,000	28,000	32,000	36,000	40,000
	Florida DOT†	NA	NA	34,000	35,500	NA
	Douglas County	NA	NA	24,000	28,800	32,000
	2014 Thresholds	18,000	20,000	24,000	28,800	32,000
4-lane minor arterial	Parsons	21,600	25,200	28,800	32,400	36,000
	Florida DOT‡	NA	NA	22,700	28,800	31,600
	Douglas County	NA	NA	21,000	NA	28,000
	2014 Thresholds	15,000	18,000	21,000	25,000	28,000
4-lane collector	Parsons	18,000	21,000	24,000	27,000	30,000
	Florida DOT	NA	NA	11,500	25,500	28,900
	Douglas County	NA	NA	21,000	NA	28,000
	2014 Thresholds	15,000	18,000	21,000	25,000	28,000
2-lane collector	Parsons	9,000	10,500	12,000	13,500	15,000
	Florida DOT¶	NA	NA	4,200	9,600	12,100
	Douglas County	NA	NA	10,500	NA	14,000
	2014 Thresholds	7,500	9,000	10,500	12,500	14,000

* Areas transitioning into urbanized areas
 ** Uninterrupted flow highways
 † 0.00 to 1.99 signalized intersections per mile
 ‡ 2.00 to 4.50 signalized intersections per mile
 ¶ Non-state roadways in Florida



2017 Douglas County Transportation Plan

For example, a 4-lane minor arterial reaches the Douglas County level of service maximum of LOS C at 21,000 ADT. For the same type of facility, Parsons recommends a 28,800 vehicle maximum and the Florida Department of Transportation allows a maximum of 22,700 vehicles. Douglas County has a stricter designation of what constitutes a significant level of delay caused by traffic than the comparison areas. The travel demand model and ADT volumes indicate that all of the County-maintained roadways are currently operating at LOS B or better during peak times, except Riverview Drive and Stephanie Way from U.S. 395 to South Santa Barbara Drive, which are operating at LOS C. All of the NDOT-maintained roads are currently operating at LOS D or better, except U.S. 395 from Mica Drive to I-580 in Carson City which is operating at LOS F, and U.S. 395 from Muller Parkway to SR 88, which is operating at LOS E.

The 2014 level of service thresholds, shown in **bold** text in Table 4.5, are the thresholds used in the Douglas County/Carson City Travel Demand Model to evaluate the level of service for Douglas County based on the functional classifications established by the County and shown on Figure 4.1.

4.1.4 EXISTING PERFORMANCE AND NEAR-TERM CHALLENGES

At the current time, a significant transportation issue in Douglas County is the concern about traffic safety and capacity along the U.S. 395 corridor through the towns of Gardnerville and Minden. U.S. 395 is the primary corridor through Carson Valley, with a limited number of parallel roads that could absorb any through traffic. In addition, U.S. 395 transitions into historic Main Street through the towns of Gardnerville and Minden, where many local commercial and retail businesses front on the highway. People and vehicles accessing those businesses have conflicts with the motorists who want to travel through these commercial areas as quickly as possible. Another consequence of through traffic being funneled onto U.S. 395/Main Street is that pedestrians and bicyclists have difficulty crossing the highway safely.

In 2007, NDOT completed the *U.S. 395 Southern Sierra Corridor Study*, which considers many of these issues. The study recommends working closely with Douglas County to implement roadway safety and capacity improvement projects.

Douglas County grew steadily from 1990 through 2005. Since that time, growth has slowed considerably, but has recently begun to accelerate. (Refer to Table 2.2, Annual Residential Permits Issued, Dwelling Units Constructed.) The existing transportation infrastructure has been able to cope with the effects of this growth, preserving acceptable traffic flow (LOS C on Douglas County facilities, LOS D on NDOT facilities) on most roadways.



2017 Douglas County Transportation Plan

Under existing road network and traffic conditions, the travel demand model and ADT volumes indicate that two road segments are currently experiencing level of service (LOS) deficiencies:

Existing LOS Deficiencies with Existing Road Network (no projects)

Road Segment	LOS
U.S. 395 from U.S. 50 to Mica Drive	F
U.S. 395 Muller Lane to SR 88	E

Given the magnitude of the projects needed address these LOS deficiencies, it is virtually impossible that they can be addressed in the short-term. Accordingly, the projects needed to address these deficiencies are included in the list of project for completion by 2025. Nevertheless, it should be noted that the County’s 2017 5-Year Transportation Plan indicates that Buckeye Road is planned to be connected to U.S. 395 north of Minden via Heybourne Road and Muller Parkway no later than 2017. Although this connection is not anticipated to improve the LOS on U.S. 395 from Muller Lane to SR 88, it will provide an alternate route for some drivers.

4.2 Vision/Guiding Policies and Principles

The 2007 Douglas County Transportation Plan identified the following policies:

- 4.2.1 *Identify high accident locations and take appropriate actions to ensure continued public health and safety.*
- 4.2.2 *Provide appropriate traffic control devices on new and existing transportation facilities.*
- 4.2.3 *Protect public safety by removing snow and other hazards from roadways.*
- 4.2.4 *Post appropriate speed limits based on current speed limit studies.*
- 4.2.5 *Remove litter, trash and debris from the roadside and the right-of-way to keep roadways within Douglas County aesthetically pleasant.*
- 4.2.6 *Implement selected near-term traffic safety and traffic operations improvements from 2017 to 2020.*
- 4.2.7 *Implement mid-term road improvements to provide acceptable traffic operations from 2017 to 2025.*
- 4.2.8 *Implement long-term road improvements to provide capacity and mobility from 2026 to 2040.*
- 4.2.9 *Maintain a traffic level of service “D” on all NDOT roads within Douglas County, consistent with NDOT standards.*
- 4.2.10 *Develop a “pedestrian-friendly” U.S. 395/Main Street corridor through Minden and Gardnerville. (See Complete Streets Policy dated January 19, 2016.)*



2017 Douglas County Transportation Plan

- 4.2.11 *Support NDOT projects that maintain traffic flow (high speed and capacity) on U.S. 395 between Minden and Carson City, as identified in the U.S. 395 Southern Sierra Corridor Study (2007).*

Douglas County and the Carson Valley are closely tied with the Carson City area, and U.S. 395 is the main travel corridor connecting these two areas. It will be necessary to make improvements to this highway as new development creates additional trips. In addition, it may be necessary to construct grade-separated interchanges at specific locations.

- 4.2.12 *Support possible bypass facilities to keep traffic moving through Minden and Gardnerville.*

The U.S. 395/Main Street corridor is important to the vitality and the sense of community in Douglas County. As the largest towns in the county, Minden and Gardnerville have a strong desire to preserve their identity and character. Local residents developed the *Minden Plan for Prosperity* (2003) and the *Gardnerville Plan for Prosperity* (2006) along with *Design Guidelines* to address their most important issues. The plans made the following recommendations:

- Provide traffic signals at selected intersections to allow pedestrian crossings of U.S. 395.
- Provide medians and crosswalks to facilitate pedestrian and bicycle connections.
- Use traffic calming devices to slow traffic through towns for safe access to local businesses.
- Improve the image of U.S. 395 by creating walkable streetscapes.

Construct the following projects (if needed):

- In the north part of Minden, west of U.S. 395, near the intersection with SR 88, construct a connection from U.S. 395 to SR 88 which bypasses the existing Ironwood development and the Douglas High School.
- On SR 88, from the bypass of the Ironwood/Douglas High School area to Kimmerling Road and the extension of Dressler Lane from SR 88 to U.S. 395, increase capacity from two lanes to four lanes.
- In the south part of Carson Valley, south of Dresslerville, from U.S. 395 to SR 88, construct a two-lane collector generally running in an east-west direction as an extension of Dressler Lane.
- Other projects identified by NDOT to provide highway bypass facilities consistent with the guiding principles stated in this section.

- 4.2.13 *Develop a truck routes plan to keep excessive through traffic out of neighborhoods.*

Current truck levels are not excessive in Douglas County; however, the county needs to plan for future growth in the area.



2017 Douglas County Transportation Plan

County Code Title 10 Vehicles and Traffic, Section 10.08 Control Devices has recently been updated to more clearly address truck traffic restrictions in Douglas County. Refer to 10.08.040 Vehicle restrictions on highways or streets, and 10.08.050 Vehicle restriction exceptions, both updated in 2016. Also refer to 10.08.020 Placement of traffic control devices in general improvement districts.

4.2.14 *Resolve/prevent neighborhood traffic issues by providing adequate through traffic facilities on major collectors and arterials.*

As the levels of traffic increase, there are more conflicts between vehicles and neighborhood residential uses. Arterial and collector streets should be designed to provide sufficient capacity to reduce through traffic on local streets. Traffic calming measures may be employed in a supporting role where required.

The fundamental challenge is to develop an adequate county-wide transportation network that will service traffic needs within the Minden/Gardnerville area and will provide adequate traffic capacity for movement to the Carson City area. Douglas County will continue to explore ways to provide north–south and east–west collectors and arterials, including providing additional capacity on Heybourne Road, Vicky Lane, Stephanie Way and Johnson Lane.

In 2025 with the existing roadway network (i.e., without construction of Muller Parkway), U.S. Highway 395 is anticipated to experience localized LOS failures in the downtown area and from SR 88 north to Muller Parkway. Completion of a two-lane Muller Parkway from Pinenut Road with a posted speed limit of 45 mph (the design speed) provides a very attractive alternative to U.S. 395 through the downtown area. These improvements result in acceptable LOS on U.S. 395 but LOS E and F on Muller Parkway from Toler Lane to Heybourne Road. Accordingly a 4-lane Muller is recommended for construction by 2025.

4.2.15 *Provide traffic transitional facilities (such as traffic circles/roundabouts) in the Minden/Gardnerville area.*

4.2.16 *Maintain a current map of proposed Douglas County transportation improvement projects.*

4.2.17 *Maintain current design standards for Douglas County roadway classifications as identified in the Douglas County Design Criteria and Improvement Standards Manual.*

4.2.18 *Maintain a level of service “C” or better on all Douglas County streets and roadways.*

The 1996 Douglas County Master Plan and the 2007 Transportation Plan stated that the minimum standard for the county road network is LOS C, which indicates stable-flowing traffic with acceptable delays. The 2014 and 2015 traffic counts and the travel demand model indicate that the current level of service is C or better on all



2017 Douglas County Transportation Plan

County-maintained streets and highways in Douglas County. Constructing the capacity-increasing projects identified in Tables 4.7 and 4.8 will keep the traffic level of service from falling below LOS C on County-maintained roads.

4.2.19 *Provide transitional facilities between higher and lower classes of roadway functional types.*

As roadway facilities are improved or developed in Douglas County, transitions are needed between higher capacity, higher speed facilities and lower capacity, lower speed facilities. In Minden, for example, a transition is needed between the north-south alignment of U.S. 395, which is currently a four-lane divided highway functioning much like a freeway, and the northwest-southeast alignment of U.S. 395 through Minden and Gardnerville. Traffic signals may be installed as an interim traffic control device.

It could be beneficial to install a traffic circle/roundabout at the intersection of Muller Lane and U.S. 395 at some point in the future. These types of transitional facilities are more effective than traffic signals when used in areas where the traffic volumes are greater than what a traffic signal would typically accommodate. Traffic is able to move through this type of facility more quickly and with fewer accidents than a conventional signalized intersection, while also serving as a transition between higher and lower speed facilities.

4.3 Transportation Capital Improvement Projects

The existing transportation plan has guided infrastructure improvement since 2007. The *2017 Douglas County Transportation Plan* lists the street and highway projects needed to accommodate planned growth in Douglas County up to the year 2040. These projects are identified in Tables 4.7 and 4.8. These projects have been incorporated into the travel demand model to determine the phasing necessary to maintain LOS standards. The travel demand model indicates that by completing these projects, the travel network will be able to accommodate the estimated traffic volumes in 2025 and 2040 and maintain traffic level of service C on Douglas County roadways, and LOS D on NDOT roadways. The county can then adopt projects from Plan into the Douglas County 5-Year Transportation Plan.



2017 Douglas County Transportation Plan

4.4 Near-Term Improvement Projects identified in the *U.S. 395 Southern Sierra Corridor Study (2007)*

System-wide transportation improvements are generally quite expensive, costing millions of dollars and often taking 10 to 20 years to complete. By contrast, near-term safety improvements can improve traffic safety and operations at a substantially lower cost and with a quicker implementation schedule. This report section contains projects that were listed in previous documents—the *U.S. 395 Southern Sierra Corridor Study (2007)* and the *2007 Douglas County Transportation Plan*.

Simultaneous with developing the *2007 Douglas County Transportation Plan*, Parsons prepared the *U.S. 395 Southern Sierra Corridor Study* for the NDOT. A significant part of the study was the 2007 public outreach effort, known as the traffic safety charrette, which generated numerous near-term safety recommendations for specific projects within the U.S. 395 corridor and at selected intersections. The corridor study recommended implementing these safety improvements within three to five years. NDOT representatives provided the cost and schedule estimates in 2006. The estimated project schedule is effective from the date of NDOT approval and funding.

Table 4.6 summarizes the near term recommendations from 2007 that were identified in the corridor study that have not yet been implemented. The locations of these improvements are shown in Figure 4.3. Additional information regarding these improvements follows Figure 4.3.

Table 4.6: Summary of U.S. 395 Safety Improvements Recommended as Near Term in the *U.S. 395 Southern Sierra Corridor Study (2007)*, not yet implemented

PROJECT	LIMITS AND ACTIONS	SCHEDULE	COST ESTIMATE*
Corridor Improvements			
1. Widen roadway markings	Entire corridor	6 months	\$ 36,000
Acceleration/Deceleration Lanes			
2. Jacks Valley Road	Extend three lanes southbound through intersection	18-36 months	\$480,000
3. Mica Drive	Add truck climbing lane to Sunridge Drive	18-36 months	\$720,000
4. South Sunridge Drive	Add northbound acceleration and deceleration lanes	18-36 months	\$480,000
5. Silver City RV Resort	Add northbound acceleration and deceleration lanes	18-36 months	\$570,000
6. Johnson Lane	Add northbound acceleration lane	18-36 months	\$780,000
Other Intersection Improvements			
7. Muller Lane	Install traffic signal	18-36 months	N/A
8. Ironwood Drive	Remove eastbound/westbound left-turns	18-36 months	N/A
Roundabouts			
9. Ironwood Drive	Construct roundabout	24-48 months	N/A
10. SR 88	Construct roundabout	24-48 months	N/A
Project Evaluations/Studies			
11. Roadway Access Management Study		6-18 months	\$ 20,000
12. Traffic Signal Installation and Coordination Study		18 months	\$420,000

* Cost estimate from 2007 *U.S. 395 Southern Sierra Corridor Study*, updated to 2016 dollars

2017 Douglas County Transportation Plan

Figure 4.3: Locations of U.S. 395 Safety Improvements Recommended as Near Term in the NDOT U.S. 395 Southern Sierra Corridor Study (2007) (Reference Table 4.6)





2017 Douglas County Transportation Plan

4.4.1 ACCELERATION/DECELERATION LANES

High-speed traffic makes entering and exiting U.S. 395 a difficult task. Adding or extending acceleration/deceleration lanes at intersections and driveways would improve this situation.

Jacks Valley Road

Currently, the right travel lane on southbound U.S. 395 becomes a right-turn only lane at the intersection of Jacks Valley Road. The 2007 Corridor Study recommends continuation of this lane through the intersection, ending south of the shopping center driveway south of Jacks Valley Road. It may be feasible to complete this project when future development occurs.

Mica Drive

Northbound trucks must come to a complete stop for the traffic signal at Mica Drive/Sunridge Drive, and their slow start-up speeds cause traffic to back up. It was recommended in the 2007 report that Douglas County pursue a project with NDOT to construct a truck climbing lane from Mica Drive to Sunridge Drive. The lane would allow for a right-turn lane to serve the residential area access from Sunridge Drive. Implementation would take between 18 and 36 months from the time of NDOT approval and funding.

South Sunridge Drive

New home construction in this area has increased the number of vehicles turning into and out of this street. Currently, vehicles must enter the outside travel lane to travel northbound. Northbound traffic must reduce its speed within the northbound outside travel lane to make a right-turn onto South Sunridge Drive. The 2007 Corridor Study recommends that Douglas County pursue a project with NDOT to add northbound acceleration and deceleration lanes to serve this traffic. The project would take between 18 and 36 months to complete from the time of NDOT approval and funding.

Silver City Recreational Vehicle Resort

Large recreational vehicles (RV) access a commercial site via a private driveway on U.S. 395 near South Sunridge Drive. Due to the size of the vehicles and the distance needed to decelerate for the approach or accelerate into traffic, longer deceleration and acceleration lanes are needed. Participants in the 2007 outreach effort recommended that Douglas County pursue a project with NDOT to lengthen the deceleration lane, add an acceleration lane, and lengthen the southbound left-turn lane into the RV park. The project would take between 18 and 36 months to complete from the time of NDOT approval and funding.

Johnson Lane

There is a need for an acceleration lane to facilitate traffic turning right from Johnson Lane onto U.S. 395. To widen U.S. 395 at this point, right-of-way is needed to relocate irrigation ditches and head gates. In addition, Johnson Lane should also be widened 14 feet to the north to allow for a right-turn lane. It was recommended in 2007 that Douglas County pursue a project with NDOT to make these changes. It would take an estimated 18 to 36 months to complete the project from the time of NDOT approval and funding, not including right-of-way acquisition.



2017 Douglas County Transportation Plan

4.4.2 ACCESS MANAGEMENT

It is necessary to manage the points where traffic enters and exits U.S. 395, which could be accomplished by eliminating or consolidating openings and moving traffic to grade-separated interchanges or newly constructed parallel routes. An Access Management Assessment was recommended in 2007. This detailed study would determine the number of approaches with median openings that should be combined, modified or removed. The study could be completed by NDOT staff at a cost of about \$20,000 in 6 to 18 months from the time of NDOT approval and funding.

4.4.3 ALTERNATE ROUTES

Suggestions for frontage roads and connections within existing county road systems were expressed during the 2007 traffic safety charrette process. Some people advocated for a new freeway alignment, while others envisioned new routes for local traffic that would preserve U.S. 395 for regional traffic. Realizing that these new roadways are expensive and require a long time to complete, these projects are listed in Section 4.5 Needs Assessment for Future Development along with other mid-term or long-term projects.

4.4.4 PAVEMENT MARKINGS

The 2007 Corridor Study recommended that NDOT replace faded markings with 8-inch-wide lines to improve visibility. The faded pavement markings have been replaced with standard width (6-inch) lines, not the wider 8-inch lines.

4.4.5 ROUNDABOUTS

Roundabouts are circular intersections with channelized approaches. In a roundabout, entering traffic yields to circulating traffic. Speeds are controlled by the design, and generally range from 15 to 27 mph. Roundabouts can be single or multiple lanes. The primary benefit of roundabouts is improved safety. Single and multiple lane roundabouts have fewer crashes with less severe injuries than signalized intersections and provide greater traffic capacity. Roundabouts are aesthetically pleasing and are sometimes used to create a gateway, or entrance, to communities.

Muller Lane

The characteristics of the U.S. 395 corridor become more suburban south of Muller Lane. During the public outreach for the 2007 update members of the public expressed the need for a gateway, or entrance, into the Minden area that would alert motorists of the need to slow down, using signs or a traffic signal. In 2007 the consultant team suggested consideration of a roundabout at this site. In 2016 the Town of Minden constructed gateway improvements (landscaping) at the U.S. 395/SR88 intersection.



2017 Douglas County Transportation Plan

Ironwood Drive

The 2007 Corridor Study recommended eliminating the left turn from the Ironwood Center onto U.S. 395 to reduce conflicts at this intersection. NDOT should partner with Douglas County to work with affected parties to ensure access needs are met.

4.4.6 TRAFFIC SIGNAL INSTALLATION AND COORDINATION

The 2007 Corridor Study recommended a Traffic Signal Installation and Corridor Study for the U.S. 395 corridor. Signal coordination is the process of timing traffic signals along a corridor to allow multiple signals to operate together as a group. It provides a means by which the sequence of green lights is established along a series of traffic signals to provide a consistent flow of traffic through a corridor.

Figure 4.4 shows the locations of existing signalized intersections in the U.S. 395 corridor through Minden and Gardnerville, as well as locations for potential future roundabouts or traffic signals. The estimated cost for completing the signal coordination project is \$420,000. The project could be completed within 18 months of initiation.

4.4.7 IMPLEMENTATION OF NEAR-TERM IMPROVEMENTS

The 2007 Corridor Study public outreach effort resulted in numerous recommendations to improve safety on U.S. 395 between U.S. 50 and the Nevada/California state line over the next three to five years, most of which are located in Douglas County. Strategies for implementation are dependent on the type of process and available funding applicable to each recommendation.

According to NDOT procedures, Douglas County must submit an application for each individual project to NDOT. Once NDOT determines that the project application is complete, the project is ranked against other projects in the state. NDOT implements these projects as funding becomes available. Project steps include securing funding, working with Douglas County and property owners, and scheduling the work.

Some recommended improvements qualify for the NDOT Safety Improvement Program or as District II maintenance projects. Those include:

- Restripe shoulders and lanes with 8-inch wide markings
- Conduct access management assessment
- Eliminate left-turn lane at Ironwood Drive

Figure 4.4: Existing Traffic Signals and Potential Future Roundabouts or Traffic Signals in the U.S. 395 Corridor

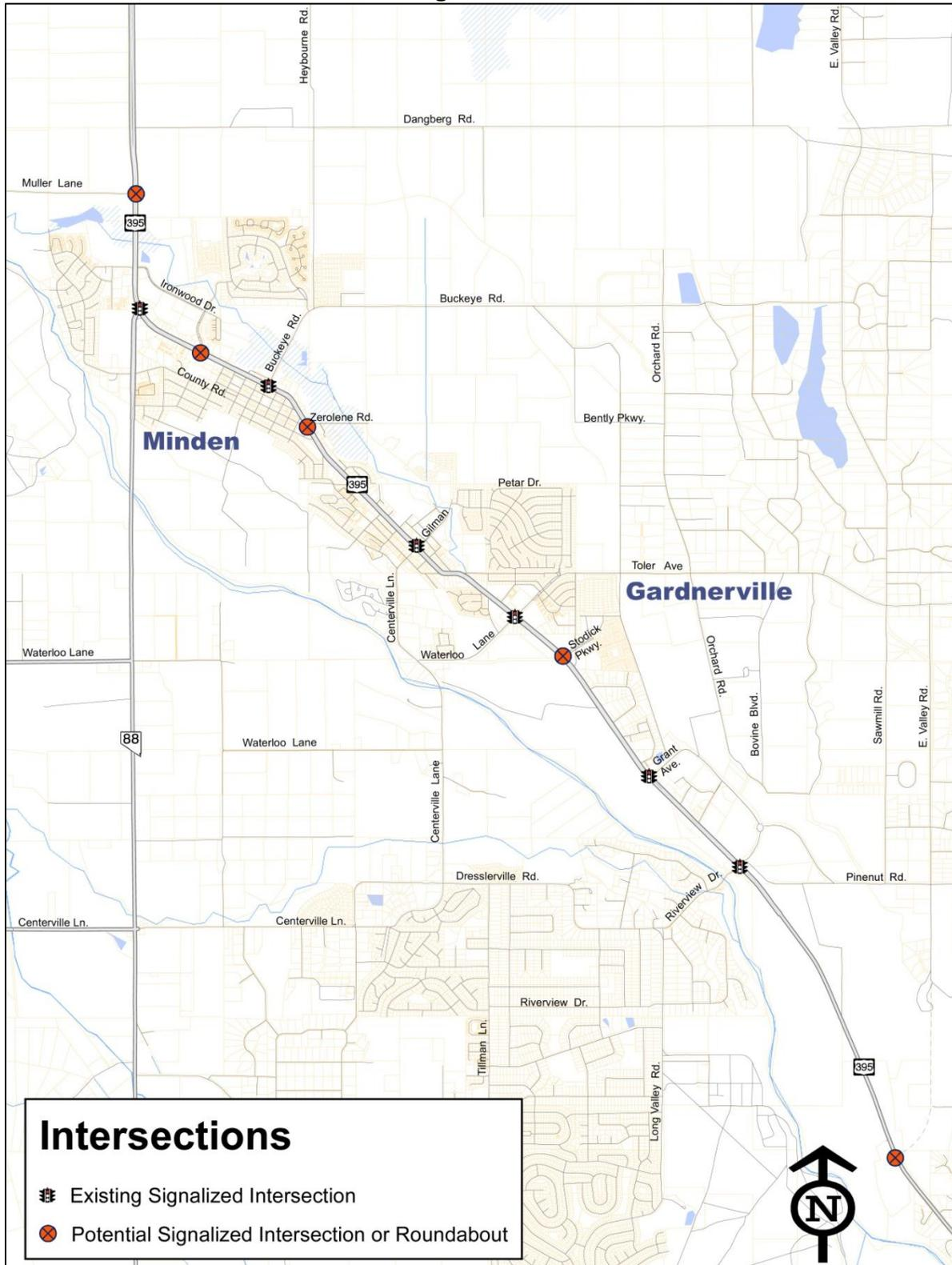



2017 Douglas County Transportation Plan

The projects listed below must go through a project development process as required by the Nevada Legislature.

- Install acceleration/deceleration lanes
- Install truck climbing lane from Mica Drive to Sunridge Drive
- Extend third lane past Jacks Valley Road
- Lengthen right-turn pocket on Johnson Lane

The following short-term improvement projects are taken from the *2007 Douglas County Transportation Plan* and remain current in this updated Plan.

4.4.8 INTERSECTIONS ALONG U.S. 395 IN THE TOWN OF MINDEN

The 2007 Corridor Study noted that, as redevelopment occurs on parcels adjacent to the intersections of U.S. 395 with Esmeralda Avenue and Mono Avenue in Minden, there will be opportunities to acquire right-of-way to realign the intersections as perpendicular intersections. If right-of-way can be acquired, Douglas County can design and construct these improvements, similar to the realignment of County Road at U.S. 395.

4.4.9 U.S. 395 IN THE TOWNS OF MINDEN AND GARDNERVILLE

Goal 2 of the County's Valley Vision Plan (2013) reads "*Address noise, air quality, congestion, and traffic safety issues by diverting large truck traffic out of downtown areas.*" Additionally, both the Gardnerville Plan for Prosperity (2006) and the Minden Plan for Prosperity (2003) speak to the issue of traffic on U.S. 395 in the downtown area. Section One of the Gardnerville Plan states "*The increasing dependence on U.S. 395 to carry local and regional traffic has a negative impact on Minden's and Gardnerville's main street appeal*" while Section Two indicates that the public wants traffic calming and improved pedestrian access along the highway through Town. Section Two of the Minden Plan indicates that access to downtown, by cars and pedestrians, is enhanced by providing parking and pedestrian improvements, and Section Three includes an action item for downtown streetscaping.

Recent (2015) counts provided by the Nevada Department of Transportation show an average of 669 heavy (semi and multiple trailer) trucks per day travelling through the downtown area. This is approximately three percent of the total traffic volume.

Diverting trucks from downtown requires the establishment of a route around the downtown area that is available to trucks and convenient for their use. One such route could be Waterloo Lane Extension from U.S. 395/Stodick Parkway due west to SR 88, with designation as an "express route" for trucks and cars. This improvement would also provide a much-needed east/west route for trucking of construction materials. Although it would reduce overall downtown traffic somewhat, it would not eliminate the need for Muller Parkway to reduce congestion on U.S. 395 through Minden and Gardnerville.



2017 Douglas County Transportation Plan

The Town of Gardnerville supports the construction of Muller Parkway as a means of removing trucks from downtown. In fact, the Town’s Strategic Plan contains the action item “*Work with other agencies to make Muller Parkway a truck bypass. After bypass is complete work to create a center median on Main Street to beautify the downtown.*” However, this is in direct opposition to action previously taken by the Board of Commissioners. On January 6, 2005 the Board approved the current Muller Parkway alignment with the understanding that heavy trucks would be prohibited from the roadway except for local deliveries. The action taken by the Board is recorded in the minutes of the meeting as, “MOTION by Kite/Smith to approve the report as it was sent to the Planning Commission and to confirm the previous adoption of the resolution with the addition of language it is not to be a truck route and with the understanding that local deliveries would be acceptable; carried with Commissioner Johnson voting Nay and Commissioner Etchegoyhen abstaining.”

When evaluating these two potential options for removal of trucks from the downtown area, the pros and cons of each project should be considered. The Waterloo Extension from SR 756 (Centerville Road) to SR 88 would provide a truck route around the downtown area, but this project would have no appreciable impact on LOS on U.S. 395 through the towns, or elsewhere. It would serve only this one purpose. Muller Parkway, on the other hand, is needed regardless of whether or not Waterloo Lane Extension is constructed. It is needed to address future LOS deficiencies at a number of locations, including U.S. 395 through town, U.S. 395 north of the SR 88 intersection, and on Buckeye Road. Should the Board desire to reverse its 2005 action designating Muller Parkway as “not a truck route” (local deliveries allowed), Parsons recommends that the County solicit input from the public on this issue prior to making its decision.

Traffic congestion in the downtown area could also be improved by providing alternative modes of transportation, and by enhancing existing services. DART, BlueGo and the Carson Valley Airporter currently operate in the downtown area and beyond. The County could consider expanding the DART service to provide reduced headways (i.e., more frequent pickup and drop-off times.) Trolleys, either on-street with rubber tires or operating on fixed rails, could provide alternatives to travel by automobile while enhancing the experience of visitors and residents alike. (Detailed maps showing potential future alignments for the V&T Railroad in the downtown area are included in Appendix B.) Landscape, sidewalk and lighting improvements would improve walkability and encourage more pedestrian activity downtown. Finally, a traffic signal study that evaluates signal timing and the potential for traffic signal coordination should be considered for U.S. 395 corridor from Riverview Drive to SR 88.

As redevelopment occurs on parcels adjacent to U.S. 395 in Minden and in Gardnerville, site plans should be reviewed to identify opportunities to consolidate and organize driveway access locations. Implementation of these driveway modifications will improve safety and traffic flow within the corridor.



2017 Douglas County Transportation Plan

4.4.10 STATE ROUTE 88 INTERSECTIONS

Douglas County will continue to coordinate with NDOT to monitor traffic volumes and intersection delays at critical locations (County Road, Waterloo Lane, Centerville Road, Kimmerling Road). If localized intersection improvements are warranted, Douglas County will coordinate with NDOT to implement intersection improvements.

4.5 Needs Assessment for Future Development

Recent development approvals indicate the potential for substantial new residential development in the next 10 to 15 years. (Refer to Table 2.5, Tentatively Approved Residential Subdivisions, and Table 2.6, Approved Specific Plans.) The additional trips created by new development in both Douglas County and Carson City will add to existing traffic volumes, causing some County roadway segments to fall below LOS C, and some additional NDOT segments to fall below LOS D unless new transportation projects are constructed.

While land developers construct local transportation improvements in the vicinity of their projects, local growth has a regional impact on the transportation network. These regional impacts will not be mitigated by the current inventory of local roadway improvements. Therefore, a primary objective of the *2017 Douglas County Transportation Plan* is to identify regional infrastructure improvements that will preserve a high quality-of-life for Douglas County’s current and future generations of residents as development continues.

If residential and commercial development continues at the Historic Growth Rate of 1.39 percent through 2025 and no capacity increasing projects are implemented, the traffic level of service on roadway segments in Douglas County will fall below acceptable LOS standards as shown below. Projects are listed in decreasing order of LOS failure, worst first.

Table 4.7 2025 LOS Deficiencies with Existing Road Network (no projects)

ROAD SEGMENT	ALLOWABLE LOS	ANTICIPATED LOS
U.S. 395 from U.S. 50 to Mica Drive	D	F
U.S. 395 from Muller Lane to Ironwood Drive	D	F
U.S. 395 from Mica Drive to Stephanie Way	D	E
U.S. 395 from Ironwood Drive to SR 88	D	E
U.S. 395 from Cemetery Lane to Gilman Road	D	D/E
Stephanie Way from U.S. 395 to Heybourne Road	C	D
Riverview Drive from Dresslerville Road to U.S. 395	C	C/D

As the current population of Douglas County grows to the projected population of 70,400 in 2040, and if no capacity increasing projects during that time, the number and magnitude of the deficiencies will continue to grow. The following table shows the anticipated deficiencies in 2040 with the existing road network plus completion of Heybourne Road from Buckeye Road to Meridian Boulevard.



2017 Douglas County Transportation Plan

Table 4.8 2040 LOS Deficiencies with Existing Roadway Network plus Mid-term Project #5 Heybourne Road

ROAD SEGMENT	ALLOWABLE LOS	ANTICIPATED LOS
U.S. 395 from U.S. 50 to Stephanie Way	D	F
U.S. 395 from Muller Lane to Ironwood Drive	D	F
Riverview Drive from Dresslerville Road to U.S. 395	C	E/F
U.S. 395 from Ironwood Drive to SR 88	D	E
Buckeye Road from U.S. 395 to Heybourne Road	C	E
SR 756 (Centerville Lane) from S. Waterloo Lane to N. Waterloo Lane	D	E
U.S. 395 from Cemetery Lane to Toler Lane	D	D/E
Stephanie Way from U.S. 395 to Heybourne Road	C	D
Buckeye Road from Heybourne Road to Sanford Street	C	D
Heybourne Road from Buckeye Road to Stockyard Road	C	D
Dresslerville Road from Riverview Drive to Long Valley Road	C	C/D

Table 4.9 lists the mid-term, Phase 1 projects needed to maintain LOS C on roads maintained by Douglas County and LOS D on roads maintained by the Nevada Department of Transportation through 2025. The projects are listed in order of importance, most important first, as determined by the severity of the LOS deficiency that each project addresses. For example, the first four projects in table 4.9 are needed to address the worst anticipated 2025 deficiencies (LOS F) in table 4.7. The last project in table 4.9 addresses the least (and last) of the deficiencies identified in table 4.7.

Table 4.10 lists the Long-term, Phase 2 projects planned for Douglas County by 2040, needed to maintain LOS C on roads maintained by Douglas County and LOS D on roads maintained by the Nevada Department of Transportation through 2040.

Table 4.11 lists projects identified to provide alternate local and regional access that are not needed to maintain LOS standards within the 2040 planning horizon. Many of these projects were identified in the 2007 Plan as being needed to maintain LOS standards. However, the updated growth rate of 1.39 percent generates lower populations and lower traffic volumes compared to the 2.0 percent growth rate utilized in the 2007 Transportation Plan. As a result, many of the projects that were identified in the 2007 Transportation Plan are not needed to maintain LOS standards in this updated plan within the 2040 planning horizon.

Three of the projects in Table 4.11 were identified in the public input process for the 2007 Plan and were not deemed necessary to maintain LOS standards. Those are the Vicky Lane Extension to the Carson Freeway, the Heybourne Road Extension to the Carson Freeway, and the Carson Valley Eastside Bypass to the Carson Freeway. Figure 4.5 maps the locations of all of the projects listed in tables 4.9, 4.10 and 4.11.



2017 Douglas County Transportation Plan

The 2017 Douglas County Transportation Plan uses 2040 as the horizon year for planning purposes. As Douglas County continues to grow beyond that date, new transportation facilities will need to be planned and developed to accommodate future growth.

Many of the transportation projects identified on Figure 4.5 involve establishment of alignments for new roads. The alignments shown for these projects are conceptual. floodplains, steep topography, land ownership and restrictions on land use can impact projects costs, and all of these should be considered when establishing final alignments associated with new road construction. Current FEMA floodplain information can be found on the FEMA website at <https://msc.fema.gov/portal/search>. Figure 4.6 shows the topography of the Carson Valley. Figure 4.7 shows land ownership by State and Federal agencies, as well as Native American owned lands and land that is subject to conservation restrictions.

Table 4.9: Proposed Transportation Projects—2017 to 2025 (Mid-term) Needed to Maintain LOS C on Douglas County Roadways and LOS D on NDOT Roadways

ID #	ROAD	SEGMENT	IMPROVEMENTS	ESTIMATED COST**
1	U.S. 395	I-580/US50 to Jacks Valley Road	Segment 1 freeway improvements identified in the U.S. 395 Southern Sierra Corridor Study (U.S. 395 SSCS)*; overpasses at Old Clear Creek Road and Topsy Lane; interchange at Jacks Valley Road; frontage roads on both sides of freeway	\$256,600,000
2	U.S. 395	Jacks Valley Road to South Sunridge/Plymouth Drive	Segment 2 freeway improvements identified in the U.S. 395 SSCS*; overpass at Mica Drive; interchange at South Sunridge/Plymouth Drive; frontage roads on both sides of freeway	\$ 73,900,000
3	Muller Parkway	Monte Vista Avenue to Pinenut Road	Construct new 4-lane arterial	\$ 39,400,000
4	Heybourne Road	Monterra Drive to Meridian Boulevard	Construct new 2-lane collector	\$ 25,400,000
5	U.S. 395	South Sunridge/Plymouth Drive to Johnson Lane	Segment 3 freeway improvements identified in the U.S. 395 SSCS*; overpass at Stephanie Way; interchange at Johnson Lane; frontage roads on both sides	\$ 87,400,000
6	Stephanie Way	U.S. 395 to S. Santa Barbara Drive	Widen existing road from 2 lanes to 4 lanes	\$ 11,200,000
7	Riverview Drive	Dresslerville Road to U.S. 395	Widen existing road from 2 lanes to 4 lanes	\$ 10,000,000
Total				\$503,800,000

* U.S. 395 Southern Sierra Corridor Study, 2007 (NDOT)

** Estimated costs are based on the U.S. 395 SSCS (2007) costs, adjusted for inflation to 2016 using CPI data (average 2%/year)



2017 Douglas County Transportation Plan

Table 4.10: Proposed Transportation Projects—2026 to 2040 (Long-term) Needed to Maintain LOS C on Douglas County Roadways and LOS D on NDOT Roadways

ID #	ROAD	SEGMENT	IMPROVEMENTS	ESTIMATED COST**
8	U.S. 395	Jacks Valley Road to Mica Drive	Widen freeway to 6 lanes to match the 6 lanes north of Jacks Valley Road	\$ 6,000,000
9	U.S. 395	Johnson Lane to Muller Parkway	Segment 4 freeway improvements identified in the U.S. 395 SSCS*; interchanges at Airport Road/Genoa Lane; interchange or roundabout at Muller Parkway	\$147,300,000
10	Genoa Lane	West of U.S. 395	Realign Genoa Lane to meet Airport Road to facilitate a single interchange for both roads	\$ 4,000,000
11	U.S. 395	Muller Parkway to SR 88	Segment 5 improvements identified in the U.S. 395 SSCS*; widen U.S. 395 from 4 lanes to 6 lanes	\$ 12,400,000
12	U.S. 395	Riverview Drive/Muller Parkway to Rockbottom Road	Segment 7 improvements identified in the U.S. 395 SSCS*; widen from 2 lanes to 4 lanes with a continuous center left turn lane	\$ 34,800,000
13	Heybourne Road	Buckeye Road south to Gilman Avenue	Construct new 2-lane collector	\$ 14,500,000
14	Heybourne Road	Gilman Avenue east to Muller Parkway	Construct new 2-lane collector	\$ 11,500,000
15	Dresslerville Road	Riverview Drive to Long Valley Road	Widen from 2 lanes to 4 lanes	\$ 7,400,000
Total Project Cost				\$238,000,000

* U.S. 395 Southern Sierra Corridor Study, 2007 (NDOT)

** Estimated costs are based on the U.S. 395 SSCS (2007) costs, adjusted for inflation to 2016 using CPI data (average 2%/year)



2017 Douglas County Transportation Plan

Table 4.11: Proposed Douglas County Transportation Projects Needed for Alternate Local and Regional Access

ID #	ROAD	SEGMENT	IMPROVEMENTS	ESTIMATED COST**
16	Vista Grande Extension	Jacks Valley Road to Topsy Lane	Construct new 2-lane collector	\$ 3,600,000
17	North Valley Road	Topsy Lane to North Sunridge Drive	Construct new 2-lane road	\$ 7,300,000
18	Waterloo Lane Extension	U.S. 395/Stodick Parkway to SR 88	Construct new 2-lane collector	\$ 28,200,000
19	Heybourne Road	Stephanie Way to Johnson Lane	Construct new 2-lane collector	\$ 7,200,000
20	Ironwood Drive Extension	Lucerne Street to Heybourne Road	Construct new 2-lane collector	\$ 5,000,000
21	Zerolene Road	U.S. 395 to Heybourne Road	Construct new 2-lane collector	\$ 4,600,000
22	East Valley Road Connection	Fremont Street to Vicky Lane	Construct new 2-lane collector	\$ 19,000,000
23	High School Street	Gilman Avenue to Courthouse Street	Construct new 2-lane local road	\$ 3,000,000
24	Sawmill Road	Toler Lane to Aervoe Pacific	Construct new 2-lane collector	\$ 6,500,000
25	Drayton Boulevard	Pleasantview Drive to Kimmerling Road	Construct new 2-lane collector	\$ 8,100,000
26	Sawmill Road Extension	Pinenut Road south to Eastside Bypass/U.S.395	Construct new 2-lane collector	\$ 10,000,000
27	East Ranchos Connection	U.S. 395 to Long Valley Road	Construct new 2-lane collector	\$ 17,900,000
28	South Ranchos Connection	E. Ranchos Connection to Dressler Lane Connection	Construct new 2-lane collector	\$ 7,900,000
29	U.S. 395***	Rockbottom Road to Double Springs	Segment 8 improvements identified in the U.S. 395 SSCS*; extend southbound truck climbing lane 10 miles	\$ 10,200,000
30	U.S. 395 Westside Bypass	Genoa Lane to Mottsville Lane	Segment 9 improvements identified in the U.S. 395 SSCS*; Construct new 4-lane bypass	\$ 47,200,000
31	SR 88	U.S. 395 to Kimmerling Road	Segment 10 improvements identified in the U.S. 395 SSCS*; widen from 2 lanes to 4 lanes	\$ 30,000,000
32	Dressler Lane Connection	U.S. 395 to SR88/Fairview Lane	Segment 11 improvements identified in the U.S. 395 SSCS; Construct new 2-lane collector	\$ 48,600,000
33	U.S. 395 Carson Valley Eastside Bypass	U.S. 395 to I-580 Freeway	Segment 12 improvements identified in the U.S. 395 SSCS*; Construct new 2-lane arterial	\$320,000,000
34	Vicky Lane Extension	Vicky Lane to I-580 Freeway	Construct new 2-lane collector	\$116,800,000
35	Heybourne Extension	Stephanie Way to I-580 Freeway	Construct new 2-lane collector	\$113,500,000
			Total	\$814,500,000

* U.S. 395 Southern Sierra Corridor Study, 2007 (NDOT)

** Estimated costs are from the U.S. 395 SSCS (2007) costs, adjusted for inflation to 2016 using CPI data (average 2%/year)

*** This project identified in the U.S. 395 SSCS was not included in the 2007 Douglas County Transportation Plan

Figure 4.5: Map of Proposed Douglas County Transportation Projects

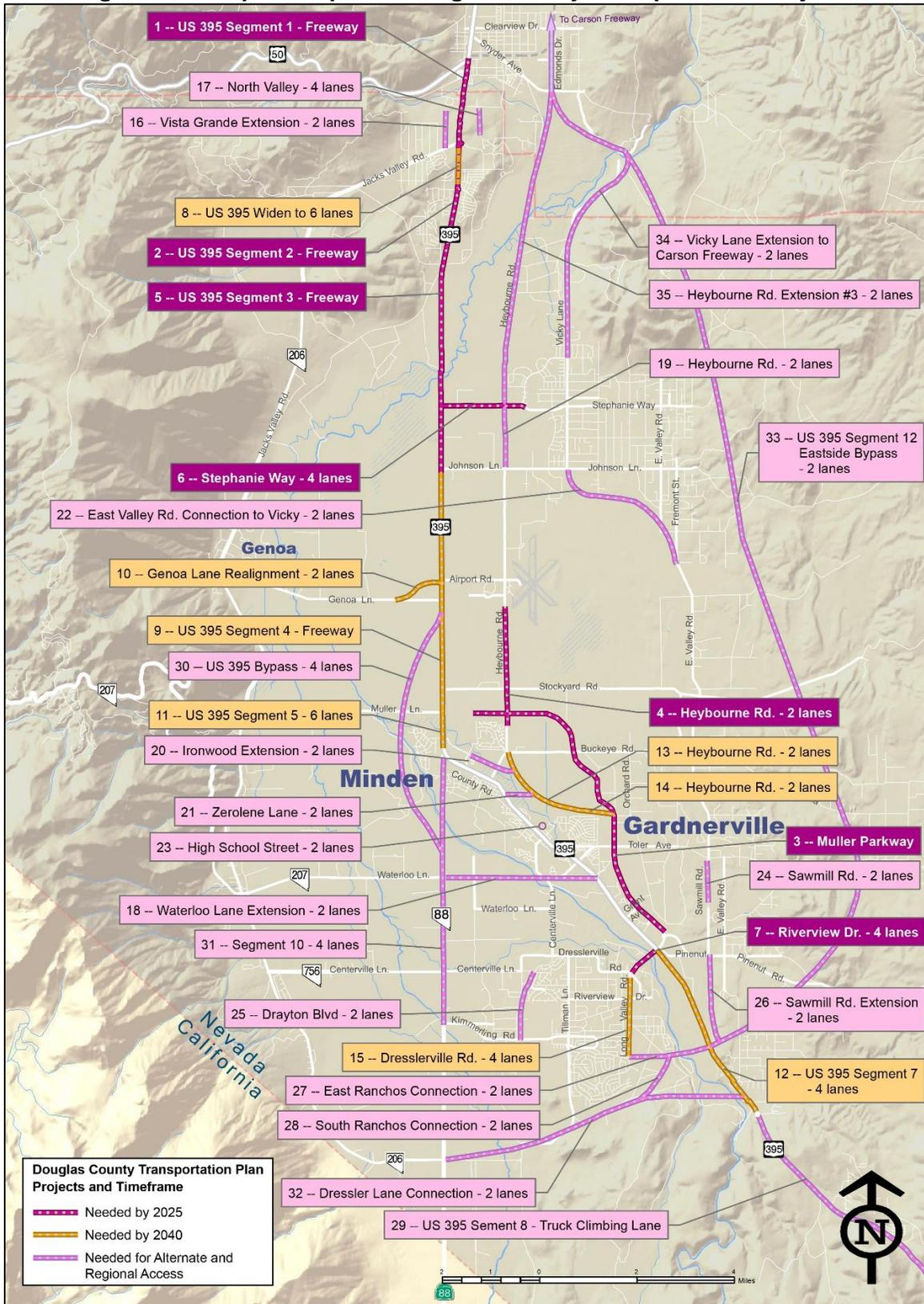

2017 Douglas County Transportation Plan

Figure 4.6: Topographic Map of the Carson Valley

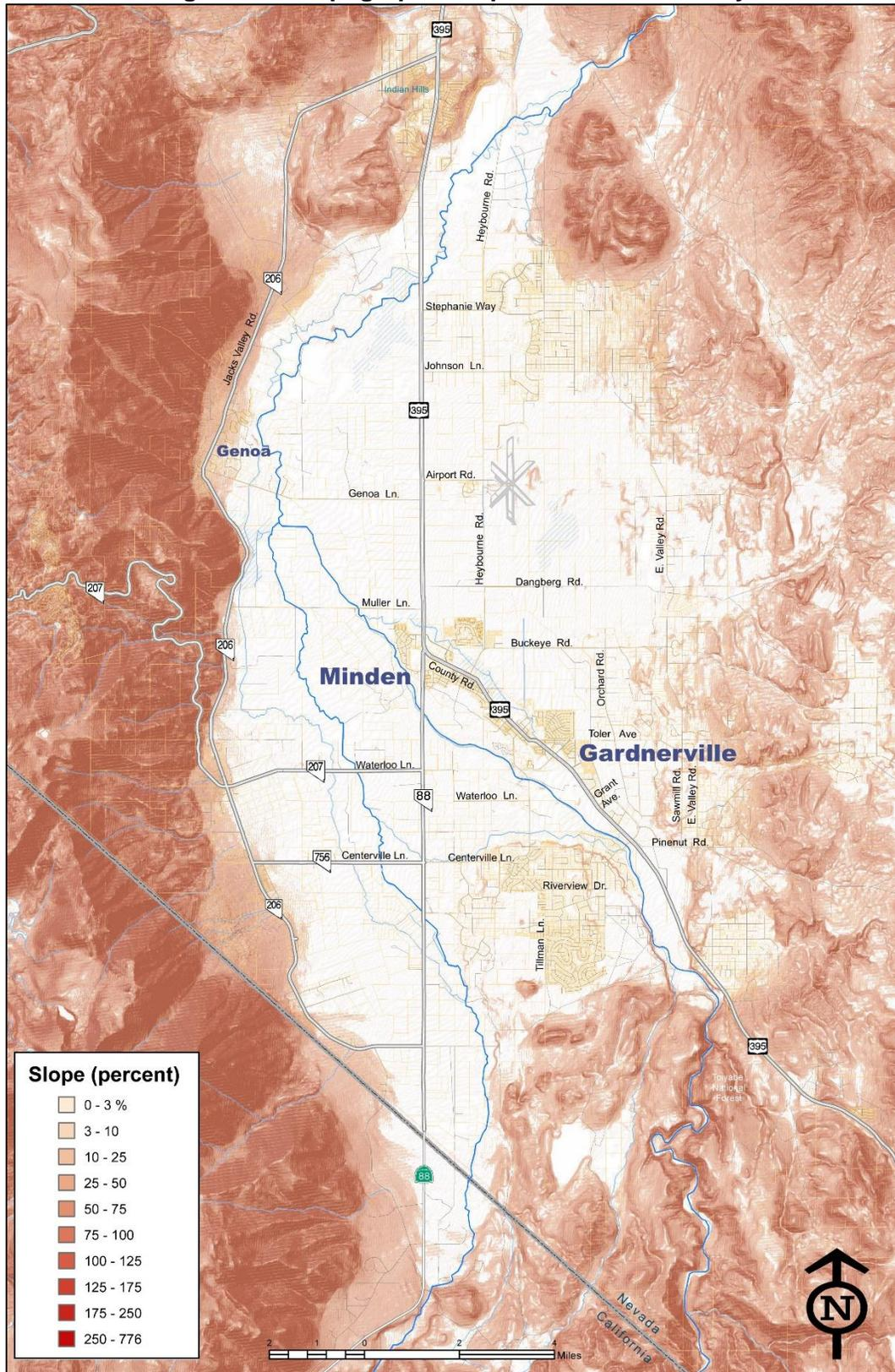
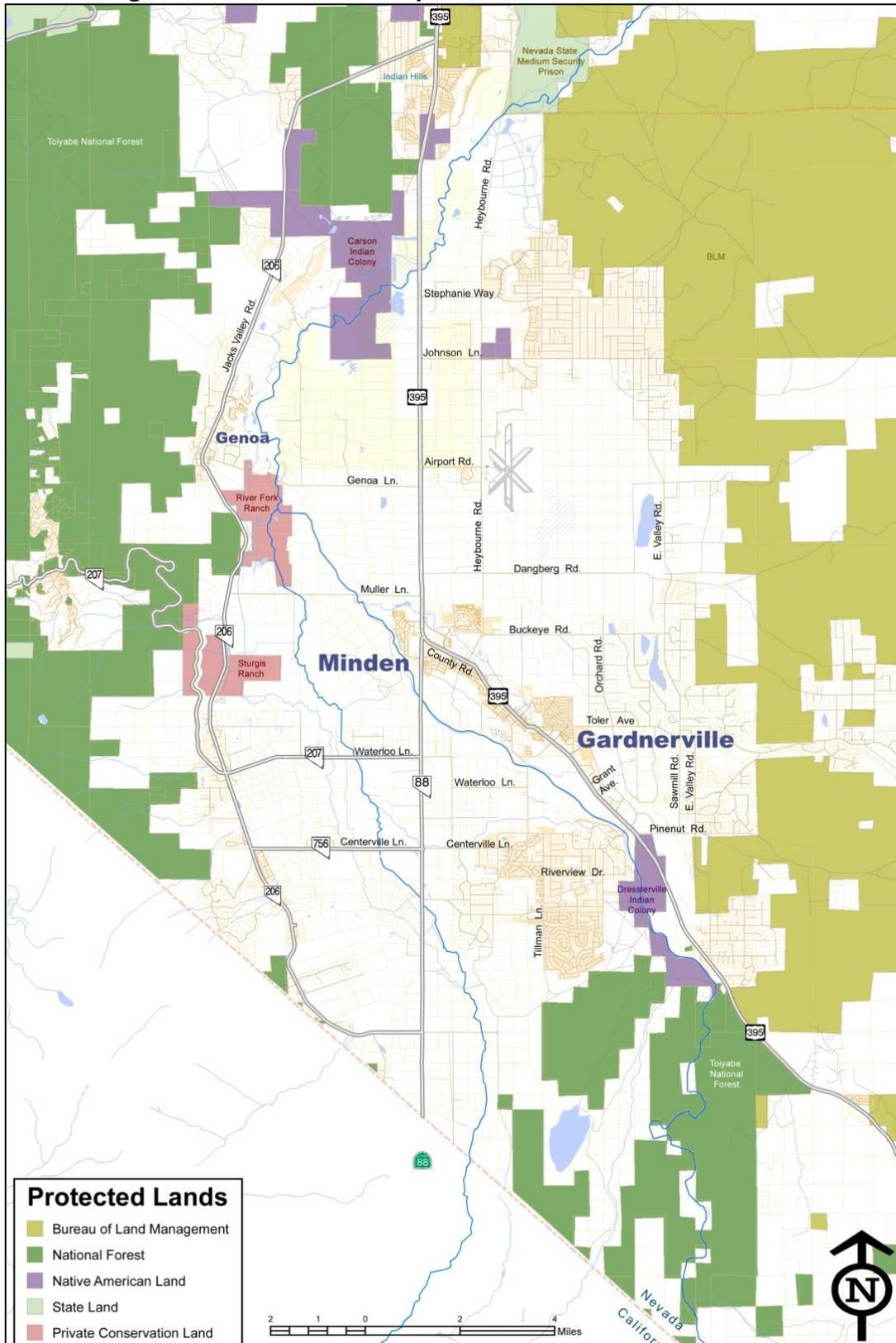

Figure 4.7: Land Ownership and Private Conservation Areas





4.6 Douglas County Street and Highway Design Standards

Each of the roadway functional classifications has different characteristics. Design standards vary with each functional classification relative to the character of the service that they provide. Roadways should be designed in accordance with the following referenced guidelines.

Nevada Department of Transportation Jurisdictional Roadways

Road Division Design, Design Manual, Parts 1 and 2, latest edition, Nevada Department of Transportation.

Douglas County Jurisdictional Roadways

Please refer to the *Douglas County Design Criteria and Improvement Standards Manual* for project standards.

Typical roadway sections and associated rights-of-way are contained in the current version of the *Douglas County Design Criteria and Improvement Standards Manual*. The right-of-way requirements were established to accommodate the roadway and local street drainage only. Additional right-of-way to accommodate drainage facilities for other than local street drainage (off-site) may be required. Additional easements/right-of-way may be required for slopes and construction.

4.7 Emergency Access Routes and Flooding

Although much of Douglas County is a high desert, flood events are not uncommon. Summer thunderstorms frequently generate localized flood events, and winter rains on snowpack can generate regional flooding. Figure 4.8, Douglas County Emergency Access Routes with Primary Flood Zones, is based on the Evacuation Routes map prepared by East Fork Fire and Paramedic Districts and Douglas County Geographic Information Systems (GIS). Ironwood Drive Extension is specifically designated as *not* an emergency access route.

4.8 Complete Streets

Complete streets refers to retrofitting roads that are under the jurisdiction of a County Commission or Regional Transportation Commission to add or repair facilities that provide safe access for all users including pedestrians, bicyclists, persons with a disability, persons who use public transportation and motorists. The term includes the operation of a public transit system but does not include the purchase of vehicles or other hardware for operation of a public transit system.

Designing complete streets can increase the overall capacity of the transportation network by encouraging more transportation modes than just private automobiles. They also encourage exercise in the forms of walking and cycling, and can reduce vehicle emissions, improve safety and promote economic development. Adopting a Complete Streets Policy means routinely designing to provide safe access for all users of all ages and abilities, regardless of mode of travel.

Figure 4.8 Map of Douglas County Emergency Access Routes with Primary Flood Zones

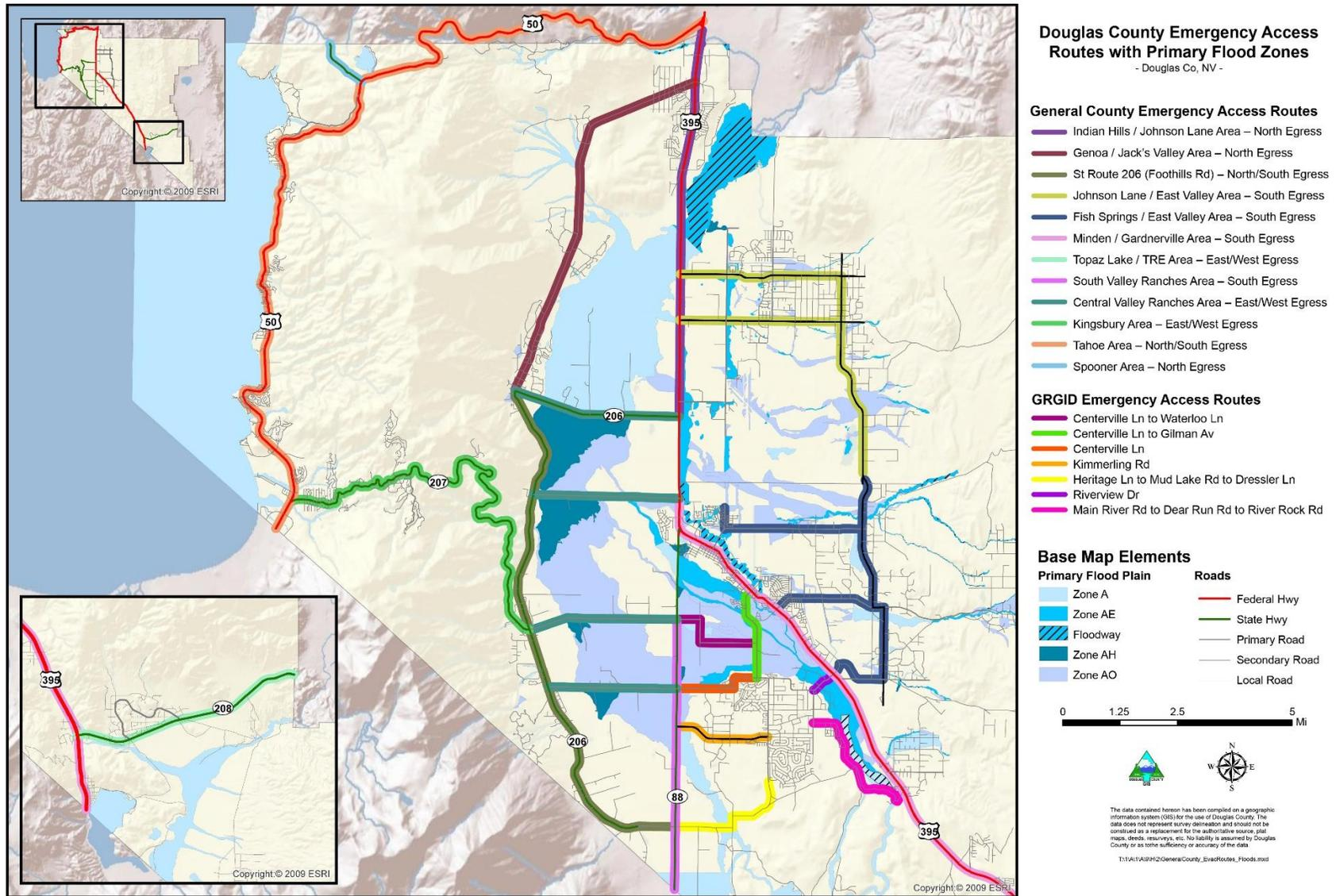



2017 Douglas County Transportation Plan

In 2013 the Nevada State Legislature approved legislation that provides funding for Complete Streets programs through the Nevada Department of Motor Vehicles. During the vehicle registration process, citizens have the option to make a voluntary donation to the Complete Streets Program. These funds are then set aside for use in the county in which they were collected. Under the legislation, a county may adopt a policy for a “Complete Streets Program” and may plan and carry out projects related to the program.

The Douglas County Regional Transportation Commission approved a Complete Streets Policy Statement on January 19, 2016 and is currently collecting funds from the program.

Chapter 5 PUBLIC TRANSPORTATION ELEMENT

Public transportation is an important part of the overall transportation system, providing mobility to residents who do not have access to private vehicle usage, such as people with low incomes, the elderly and persons with disabilities. Public transportation also has the potential to reduce traffic congestion and vehicle emissions, depending on the number of people using the system. In addition to providing mobility within Douglas County, public transit allows residents to access regional employment, education and health care services located in the Carson City and Reno/Sparks area.

Douglas County is primarily a rural county, with a small, urbanized area surrounding Minden and Gardnerville. Because of Douglas County’s dispersed pattern of development, transit must be carefully designed to serve the county’s population at a reasonable cost. Lifeline transit services, such as the ones connecting Topaz Lake with north Douglas County and Kingsbury Grade to Lake Tahoe, allow Douglas County residents and visitors to reach essential services and activities with reasonable frequency.

5.1 Existing Public Transportation Services

It must be noted that transit service operations change frequently in response to market conditions. Accordingly, the schedules contained herein may or may not be current.

5.1.1 DOUGLAS AREA RURAL TRANSIT (DART) DIAL-A-RIDE

Douglas County operates the Douglas Area Rural Transit (DART) Dial-A-Ride service, which carries passengers between the southern-most and northern-most points of the county along the U.S. 395 corridor. Most of this service occurs in the rural portions of Douglas County, allowing for use of funding from the Federal Transit Administration’s Rural Transit Assistance Program.

The Dial-A-Ride service extends from the Topaz Ranch Estates Community Center (near Topaz Lake) in the south to the Indian Hills community in the north. The Dial-A-Ride provides door-to-door service to seniors age 60 and over and disabled persons for shopping, medical appointments, recreation, Senior Center visitation and more. Rides must be scheduled in advance.

DART is funded with a one percent room tax on transient occupancy, Federal Transit



DART driver Renée D’Accardo proudly displays her vehicle

2017 Douglas County Transportation Plan

Figure 5.1: DART Service in Effect as of April 2016

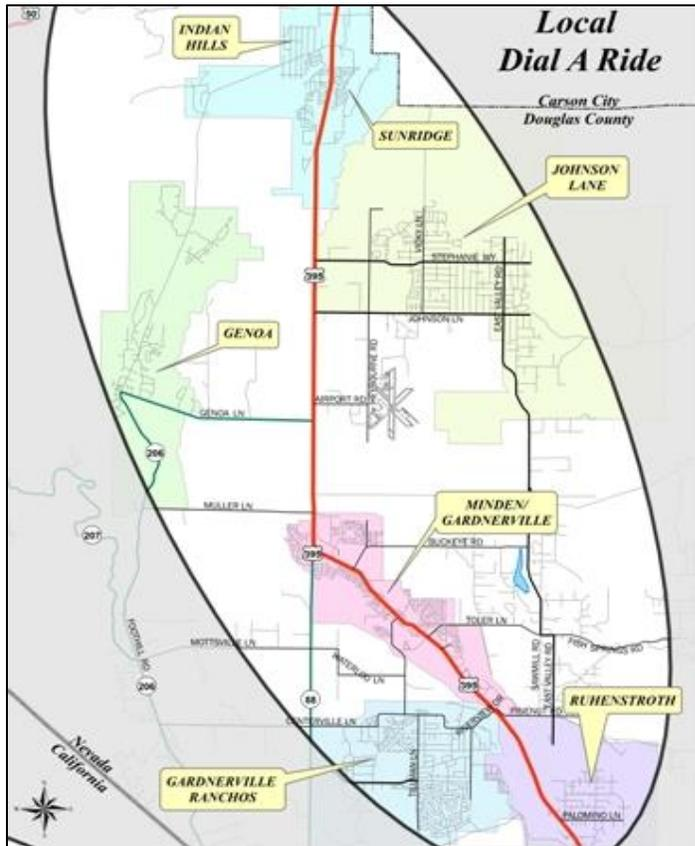

Source: Douglas County, Nevada, www.douglascountynv.gov/
 Note: Best quality map available at the time of publication.

Administration funds and the Douglas County General Fund. The cost for fiscal year 2014–2015 is \$493,378.

For the period from July 2014 through June 2015, DART public transportation provided 33,755 passenger trips (an average of 2,813 trips per month). Vehicle revenue miles totaled 169,381. Vehicle revenue hours totaled 13,800, operating 13 hours per day for the entire year. Douglas County collected \$11,500 in passenger fares during this time period.

5.1.2 DART EXPRESS

DART Express is a public fixed route that transports passengers to Minden, Gardnerville and the Gardnerville Ranchos. Specific transfer points are built into the route, to be shared with the Tahoe Transportation District for passengers seeking to ride north to Carson City (19X Express Route) or to South Lake Tahoe and Stateline ski areas (20X Lake Express Route). Once in Carson City, passengers can take Washoe RTC intercity regional transit service to Reno and Sparks.

Figure 5.2: DART Express Route Map

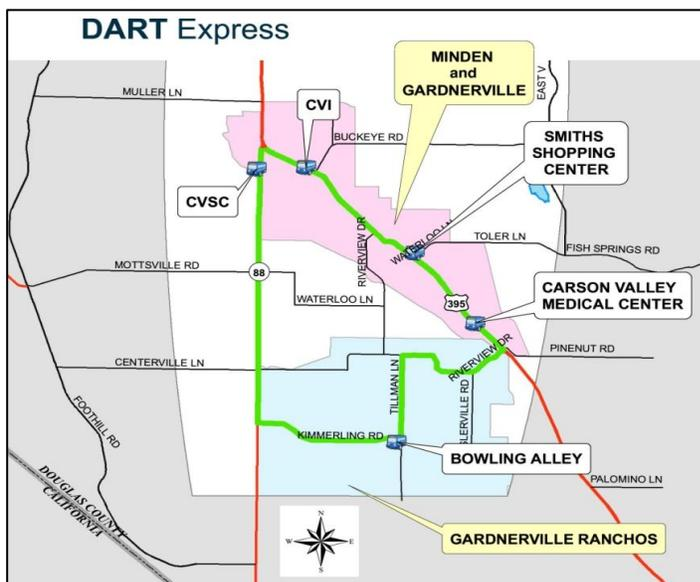

Source: Douglas County, Nevada, www.douglascountynv.gov/

For visitors and residents of Douglas County, the DART Express offers transportation to points of interest such as Tillman Center, the Carson Valley Medical Center, shopping centers located in Gardnerville (Smith’s, Raley’s, and Grocery Outlet), Herbig Park, Lampe Park, the senior center, the Carson Valley Inn, the library and Carson Valley Swim Center.



2017 Douglas County Transportation Plan

Table 5.1: DART Express Schedule

Northbound – DART EXPRESS									
	TILMAN CENTER (Bowling Alley)	CARSON VALLEY MEDICAL CENTER	WALMART	COMMUNITY/ SENIOR CENTER	SHOPPING CENTER (Smiths)	CARSON VALLEY INN	LIBRARY	CARSON VALLEY SWIM CENTER	IRONWOOD CENTER
Route # 1	7:10 am	7:20 am	7:25 am	7:35 am	7:40 am	7:45 am	—	8:00 am	8:05 am
Route # 3	11:00 am	11:10 am	11:15 am	11:25 am	11:30 am	11:45 am	11:50 am	11:55 am	12:00 pm
Route # 5	4:00 pm	4:10 pm	4:15 pm	4:25 pm	4:30 pm	4:40 pm	4:45 pm	4:50 pm	4:55 pm
Southbound – DART Express									
	IRONWOOD CENTER	CARSON VALLEY SWIM CENTER	LIBRARY	CARSON VALLEY INN	SHOPPING CENTER (Smiths)	COMMUNITY/ SENIOR CENTER	WALMART	CARSON VALLEY MEDICAL CENTER	TILMAN CENTER (Bowling Alley)
Route # 2	8:05 am	8:10 am	—	8:15 am	8:30 am	8:35 am	8:45 am	8:50 am	9:00 am
Route # 4	2:35 pm	2:40 pm	2:45 pm	2:55 pm	3:10 pm	3:20 pm	3:30 pm	3:35 pm	4:00 pm
Route #6	4:55 pm	5:00 pm	5:05 pm	5:15 pm	5:20 pm	On Call	5:30 pm	5:35 pm	5:45 pm

5.1.3 BlueGo TRANSIT SERVICE

Transit service in Douglas County is connected to the Lake Tahoe area through the Tahoe Transportation District (<http://www.tahoetransportation.org/>). A new, expanded BlueGo (<http://www.BlueGo.org>) bus service that connects South Shore to Carson Valley goes on to Carson City.

Fares are \$4.00 for intercity trips and \$2.00 within local areas with half-price fares offered to youth, seniors and those with disabilities. Transfer stations are located at Tillman and Kimmerling in Gardnerville, and in Carson City at Washington and Plaza Streets.

To meet growing public demand for public transit, the agencies have simplified the fare structure, allowing transportation managers to hold the line on bus fares without major price increases. In the current fare structure, BlueGo will continue its \$3.00 on-call plan for seniors and the disabled. This on-call fare is available to persons aged 60 or older, Medicare or Medicaid card-holders, or those with a valid special needs or ADA credential. For all others, the cost for on-call service is \$10.00.

See Figure 5.3 for a map of the Valley and Lake Express routes, and Table 5.2 for the fixed-route schedule for the Nevada Route.



2017 Douglas County Transportation Plan

Table 5.2: BlueGo Transit Service Schedules of Routes that Serve Douglas County and the Lake Tahoe Area



NORTHBOUND 19X - WEEKDAY EXPRESS

Tillman Center	Herbig Park/Senior Center	CVI	Starbucks Roasting Plant	Romans Rd	Fuji Park	Washington/Plaza
6:20	6:28	6:37	6:50	*	7:05	7:30
7:20	7:28	7:37	**	7:55	8:00	8:15
1:35	1:43	1:52	**	*	2:10	2:30
3:10	3:18	3:27	3:40	3:55	4:00	4:20
5:10	5:18	5:27	5:40	5:55	6:00	6:20

SOUTHBOUND 19X - WEEKDAY EXPRESS

Washington/Plaza	Fuji Park	Romans Rd	Starbucks Roasting Plant	CVI	Herbig Park/Senior Center	Tillman Center
6:10	6:23	*	6:40	6:58	7:06	7:20
7:35	7:48	7:52	8:07	8:25	8:33	8:45
9:35	9:48	*	**	10:07	10:15	10:28
3:10	3:23	3:27	3:42	4:00	4:08***	4:20***
4:45	4:58	5:02	5:17	5:35	5:43***	5:55***

*No service to this destination.
 **No service to this destination. This route will stay on US 396 and will not deviate from US 396.
 ***This bus will be identified as the Westbound 20x. This bus will complete the Southbound 19x route and then continue to Lake Tahoe as the Westbound 20x.

Note: AM Times are shown in lightface type, PM Times are shown in boldface type.

19x Route 19X operates Monday - Friday, but does not operate on weekends or the following holidays: New Year's Day, Memorial Day, Independence Day, Labor Day, Thanksgiving Day and Christmas.

WESTBOUND 20X - WEEKDAY EXPRESS

Herbig Park/Senior Center	Gillman/US 396	Tillman Center	Foothill Park & Ride	Tramway/Tina	The Ridge Resorts	Market Street (West)	Kingsbury Transit Center	Staterline Transit Center
5:25	5:27	5:35	5:48	6:03	*	6:10	6:12	6:30
6:20	6:22	6:30	6:43	6:58	*	7:05	7:07	7:25
7:00	7:02	7:10	7:23	7:38	**	7:45	7:47	8:05
4:08	4:10	4:20	4:33	4:48	**	4:55	4:57	5:05
5:43	5:45	5:55	6:08	6:23	**	6:30	6:32	6:40

EASTBOUND 20X - WEEKDAY EXPRESS

Staterline Transit Center	Kingsbury Transit Center	Market Street (East)	Tramway/Tina	The Ridge Resorts	Foothill Park & Ride	Tillman Center	Herbig Park/Senior Center
5:15	5:18	5:25	5:32	*	5:42	5:55	6:20
8:35	8:38	8:45	8:52	*	9:02	9:15	9:40
3:40	3:43	3:50	3:57	*	4:07	4:20	4:45
4:10	4:13	4:16	4:23	4:35	4:55	5:10	5:20
5:35	5:38	5:45	5:52	*	6:02	6:15	6:40

WESTBOUND 20X - WEEKEND EXPRESS

Herbig Park/Senior Center	Gillman/US 396	Tillman Center	Foothill Park & Ride	Tramway/Tina	The Ridge Resorts	Market Street (West)	Kingsbury Transit Center	Staterline Transit Center
5:25	5:27	5:35	5:48	6:03	*	6:10	6:12	6:25
7:00	7:02	7:10	7:23	7:38	**	7:45	7:47	8:00
2:35	2:37	2:45	2:58	3:13	**	3:20	3:22	3:35
3:00	3:02	3:10	3:23	3:38	**	3:45	3:47	4:00
5:15	5:17	5:25	5:38	5:53	**	6:00	6:02	6:15

EASTBOUND 20X - WEEKEND EXPRESS

Staterline Transit Center	Kingsbury Transit Center	Market Street (East)	Tramway/Tina	The Ridge Resorts	Foothill Park & Ride	Tillman Center	Herbig Park/Senior Center
6:30	6:33	6:38	6:45	*	6:57	7:10	7:30
8:00	8:03	8:08	8:15	*	8:27	8:40	9:00
3:40	3:43	3:48	3:55	*	4:07	4:20	4:40
4:10	4:13	4:18	4:25	4:33	4:55	5:08	5:20
6:30	6:33	6:38	6:45	*	6:57	7:10	7:30

*No service to this destination.
 **There is no direct service to The Ridge Resorts on Westbound 20x. Passengers travelling to The Ridge Resorts will need to disembark at Tramway/Tina and transfer to the Eastbound 20x. The only guaranteed connection time with the Eastbound 20x will be at 7:40 at Tramway/Tina. Otherwise, connection times with the Eastbound 20x are not guaranteed.
 Note: AM Times are shown in lightface type, PM Times are shown in boldface type.

20x Route 20X operates on the weekend schedule during the following holidays: New Year's Day, Memorial Day, Independence Day, Labor Day, Thanksgiving Day and Christmas.

NORTHBOUND 21X - WEEKDAY EXPRESS

Staterline Transit Center	Safeway Roundhill	Zephyr Cove	US 50 Park & Ride	Topsy Lane	Fuji Park	Washington/Plaza
5:30	5:39	5:46	on request**	6:10	6:12	6:33
6:30	6:39	6:46	on request**	7:10	7:12	7:33
8:30	8:39	8:46	on request**	9:10	9:12	9:33
2:05	2:14	2:21	on request**	2:45	2:47	3:08
3:30	3:39	3:46	on request**	4:10	4:12	4:33
5:35	5:44	5:51	on request**	6:15	6:17	6:38

SOUTHBOUND 21X - WEEKDAY EXPRESS

Washington/Plaza	South Curry	Topsy Lane	US 50 Park & Ride	Zephyr Cove Resort	US 50/Elks Point Road	Lakeside Casino	Staterline Transit Center
6:35	6:43	6:48	6:54	7:17	7:19	7:23	7:36
7:30	7:38	7:43	7:49	8:12	8:14	8:18	8:33
2:30	2:38	2:43	2:49	3:12	3:14	3:18	3:33
3:00	3:08	3:13	3:19	3:42	3:44	3:48	4:03
4:30	4:38	4:43	4:49	5:12	5:14	5:18	5:33
6:40	6:48	6:53	6:59	7:22	7:24	7:28	7:43

NORTHBOUND 21X - WEEKEND EXPRESS

Staterline Transit Center	Safeway Roundhill	Zephyr Cove	US 50 Park & Ride	Topsy Lane	Fuji Park	South Curry	Washington/Plaza
5:30	5:39	5:46	on request**	6:10	6:12	6:17	6:28
8:30	8:39	8:46	on request**	9:10	9:12	9:17	9:28
2:30	2:39	2:46	on request**	3:10	3:12	3:17	3:28
3:30	3:39	3:46	on request**	4:10	4:12	4:17	4:28
4:30	4:39	4:46	on request**	5:10	5:12	5:17	5:28

SOUTHBOUND 21X - WEEKEND EXPRESS

Washington/Plaza	South Curry	Fuji Park	US 50 Park & Ride	Zephyr Cove Resort	US 50/Elks Point Road	Lakeside Casino	Staterline Transit Center
6:30	6:38	6:43	6:47	7:10	7:12	7:16	7:28
7:30	7:38	7:43	7:47	8:10	8:12	8:16	8:28
3:30	3:38	3:43	3:47	4:10	4:12	4:16	4:28
4:30	4:38	4:43	4:47	5:10	5:12	5:16	5:28
6:30	6:38	6:43	6:47	7:10	7:12	7:16	7:28

**No service to this destination; no hay servicio.
 **Passengers must call the dispatcher at (530) 541-7149 at least one hour before the pick-up time to request a pick-up at this location.
 Note: AM Times are shown in lightface type, PM Times are shown in boldface type.

21x Route 21X operates on the weekend schedule during the following holidays: New Year's Day, Memorial Day, Independence Day, Labor Day, Thanksgiving Day and Christmas.



2017 Douglas County Transportation Plan

5.1.4 CARSON VALLEY AIRPORTER

Shuttle service is available for Carson Valley to the Reno–Tahoe International Airport. Regularly scheduled round-trip service is provided between the airport and Gardnerville and Minden four times a day. The schedule is shown in Table 5.3.

Table 5.3: Carson Valley Airporter Schedule

		Departs:			Arrives:	
Reno National Bowling Center 4th & Lake St	Reno Airport	Carson City Transportation Center	Courtyard By Marriott Carson City	Holiday Inn Express 1659 Hwy 88 Minden	Carson Valley Inn Minden	Gardnerville Community Center
10:00 AM	10:30 AM	10:59 AM	11:14 AM	11:34 AM	11:47 AM	11:55 AM
12:15 PM	12:45 PM	1:14 PM	1:29 PM	1:49 PM	2:02 PM	2:10 PM
2:45 PM	3:15 PM	3:44 PM	3:59 PM	4:19 PM	4:32 PM	4:40 PM
7:15 PM	7:45 PM	8:14 PM	8:29 PM	8:49 PM	9:02 PM	9:10 PM
Departs:					Arrives:	
Gardnerville Community Center	Carson Valley Inn Minden	Holiday Inn Express 1659 Hwy 88 Minden	Courtyard By Marriott Carson City	Carson City Transportation Center	Reno Airport	Reno National Bowling Center 4th & Lake St
6:00 AM	6:10 AM	6:23 AM	6:43 AM	6:58 AM	7:27 AM	7:57 AM
8:00 AM	8:10 AM	8:23 AM	8:43 AM	8:58 AM	9:27 AM	9:57 AM
11:55 AM	12:05 PM	12:18 PM	12:38 PM	12:53 PM	1:22 PM	1:52 PM
4:30 PM	4:40 PM	4:53 PM	5:13 PM	5:28 PM	5:57 PM	6:27 PM

5.1.5 EASTERN SIERRA TRANSIT

Eastern Sierra Transit provides round trip transit along U.S. Highway 395 between Lone Pine and Reno on Mondays, Tuesdays, Thursdays and Saturdays. The service makes one round trip daily from Lone Pine, stopping at (among other locations) Smith’s in Gardnerville (currently 10:45 a.m. northbound, 24-hour advance reservation required) and at the Carson Nugget in Carson City. On the southbound trip it stops at the AM/PM mini-market, 1338 U.S. Highway 395 on the corner of Waterloo Lane (2:30 p.m., 24-hour advance reservation required).



2017 Douglas County Transportation Plan

5.2 Evaluating Douglas County Transit Services

Public transit services should be evaluated regularly to determine if they are meeting locally established transportation objectives. One method for analyzing transit operations is to review certain quantifiable data, such as operating costs, passenger trips, fare revenue, vehicle revenue hours and miles traveled. Table 5.4 provides DART performance measures and performance indicators data for fiscal year 2014–2015.

DART is a popular and efficient service, providing 33,755 passenger trips during fiscal year 2014–2015. These trips provided transportation to the elderly and persons with disabilities, as well as regular and deviated fixed route service. The low fare recovery ratio (2.3 percent) reflects the very low fare per passenger, which is related to the social service nature of the program.

**Table 5.4: DART Measures of Effectiveness—
FY 2014 to FY 2015**

DOUGLAS AREA RURAL TRANSIT	
Performance Measures	
Operating cost	\$493,378
Fare revenue	\$11,500
Vehicle revenue hours	13,800
Vehicle revenue miles	169,381
Total passenger trips	33,755
Performance Indicators	
Operating cost/hour	\$35.75
Operating cost per passenger trip	\$14.62
Passenger trips/hour	2.45
Passengers trips/mile	0.2
Fare recovery ratio	2.33%

Source: Douglas County Community Services Division



5.2.1 PERFORMANCE MEASURES

The following definitions of performance measures and performance indicators are consistent with the definitions provided in the Federal Transit Administration National Transit Database. See Table 5.4 for DART performance measures.

Operating Cost

The full cost of operating the transit system, excluding the following items: (a) costs of depreciation and amortization, (b) direct costs of providing charter service, (c) vehicle lease costs, and (d) premiums for liability and casualty insurance and payments of liability claims.

Fare Revenue

Revenue collected from fares plus ticket/pass sales.

Vehicle Revenue Hour

The time during which a revenue vehicle is available to carry fare paying passengers, and which includes only those times between the time or scheduled time of the first passenger pickup and the time or scheduled time of the last passenger drop-off during a period of the vehicle's continuous availability.

Vehicle Revenue Mile

Those miles traveled by revenue vehicles during their vehicle revenue hours.

Total Passenger Trips

Total number of unlinked trips; all boardings, whether revenue producing or not.

5.2.2 PERFORMANCE INDICATORS

Each of these performance indicators is obtained by using simple computation of the performance measures above. See Table 5.4 for DART indicators of service effectiveness.

Operating Cost per Hour

Total operating costs for transit service divided by total hours of service provided.

Operating Cost per Passenger Trip

Total operating costs for transit service divided by total number of passenger trips provided.

Passenger Trips per Hour

Total number of passenger trips divided by total hours of vehicle revenue service provided.

Passenger Trips per Mile

Total number of passenger trips divided by total number of vehicle revenue miles.

Fare Recovery Ratio

Total fare revenues divided by total operating costs for transit service, expressed as a percentage.



5.3 Public Transportation Needs Assessment and Issues

Transit service routes are designed to connect riders with their points of origin and destination. As such, a number of key attractors should be considered when establishing transit routes. These include population centers, shopping centers, employment centers, travel hubs, education and recreation facilities.

As indicated earlier in this chapter, several entities currently provide transit services within and through Douglas County. These include DART, BlueGo, the Carson Valley Airporter and Eastern Sierra Transit. In aggregate these operations serve most of the key attractors within the Carson Valley, including the Tillman Center, Douglas County Senior Center, Herbig Park, Carson Valley Medical Center, Carson Valley Inn, Smith's shopping center, Carson Valley Swim Center and Douglas County Library. They also serve the population centers of the Gardnerville Ranchos and the downtown Minden Gardnerville area, as well as the employment areas clustered along U.S. 395 through downtown, and the Stateline casino area. Furthermore, these services connect to Washoe RTC transit providing Douglas County residents with transportation to Reno and the Reno-Tahoe International Airport.

There are a few existing attractors in Douglas County where public transit service is lacking. These include Western Nevada College, the Minden/Tahoe Airport, the Johnson Lane area, the Target shopping center, and the Carson Valley Plaza (north Walmart shopping center). The transit providers should evaluate the potential ridership associated with these attractors and consider modifying their existing routes to serve these locations.

As Douglas County continues to focus growth in the Minden–Gardnerville area and along U.S. 395, residents expect and need a more active transit service in this corridor. The estimated increase in population to 70,400 by 2040 will likely require the development of more frequent fixed route and demand responsive service covering a wider geographical area. This expanded service will become especially important as Douglas County attracts a larger population of retired residents who require more public transportation services. Increased regular transit service will require expanded DART service to transport disabled and elderly riders to health care, personal business, and shopping trips. DART currently meets all the requirements of the Americans with Disabilities Act (ADA), by providing equal access to the Douglas County transit service for disabled riders.

Increased tourist and employment activity in the Lake Tahoe area will also require an increased role for public transportation in this region. More people will visit Douglas County looking for alternatives to driving alone in single-occupant vehicles. Expanded transit service will add to the attractiveness of this already popular tourist area, by making travel convenient and accessible.



2017 Douglas County Transportation Plan

Employment growth also signals the need for expanded public transit services. With new employment facilities concentrated around the Minden–Tahoe Airport, North County and downtown Gardnerville and Minden, there will be increased demand for services in these areas. Flexible fixed route, demand-responsive and vanpool services should be considered for these employment centers.

Transit service costs will continue to rise due to increased costs for fuel, liability insurance, maintenance and labor. Douglas County will need to carefully evaluate additional transit programs to determine which services are most cost-effective. By reviewing the performance measures and the performance indicators each year, local policy makers will have the information to make effective decisions about transit service levels.

It would be appropriate for Douglas County to prepare a short range transit plan within the next three years to determine the logistics of implementing improved local transit services, including the following issues:

- Expand transit service hours, especially evenings and weekends.
- Expand transit service areas and routes to serve the key attractors where service is currently lacking.
- Connect rural communities in northern Nevada.
- Increase frequency for demand-responsive service in compliance with the Americans with Disabilities Act.
- Develop transit system goals and objectives.
- Develop a comprehensive transit financial plan.
- Preserve a transit corridor along the former Virginia & Truckee Railroad right-of-way.



2017 Douglas County Transportation Plan

5.4 Future Transportation Options

5.4.1 CARSON VALLEY/LAKE TAHOE GONDOLA

In considering potential future transportation options, Douglas County staff requested a brief analysis of a potential future gondola connection between the Carson Valley and the Lake Tahoe area. Representatives of the Heavenly Mountain Ski Resort, the Tahoe Regional Planning Agency (TRPA), the Tahoe Transportation District (TTD), and Douglas County staffs were contacted to determine if their plans contained any mention of this potential future service.

- **Mobility 2035, Lake Tahoe Regional Transportation Plan, 2012.** The plan contains no reference to a Lake Tahoe gondola/tram connection to the Carson Valley.
- **Heavenly Mountain Resort Master Plan, 2007.** The master plan identifies no plan for a future gondola connection to the Carson Valley. Heavenly Ski Resort is currently updating their master plan, which will contain no plan for a Carson Valley gondola/tram connection according to Resort staff.
- **Tahoe Transportation District documents provided on website.** None of the district documents contains any reference to a future gondola/tram connection with the Carson Valley.

A number of factors were considered in identifying potential sites for the Carson Valley terminus of the gondola, including parcel location relative to the ski resort, private versus public ownership, developed versus undeveloped condition, floodplain condition, and master plan land use and zoning.

Many of the parcels in the area east of Foothill Road are in the floodplain and/or appear to exhibit wetlands conditions. Regarding land use and zoning, of the parcels in the project vicinity only the Walley and David’s parcels currently have commercial zoning. All other parcels are zoned for either Forest and Range or Agriculture.

The distance traversed by the gondola as depicted is approximately three miles. The order-of-magnitude cost estimate for the gondola is \$30 million to \$35 million. The details are shown in Table 5.5.

Table 5.5: Carson Valley/Lake Tahoe Gondola Cost Estimate

CARSON VALLEY GONDOLA	COUNT	QUANTITY	UNIT OF MEASURE	COST (\$ million)
Parking lot parcel B		100	space	\$0.30
Cables	5	532	ton	\$10
Towers	5	550	ton	\$10 to \$15
Gondola cabins		28	ea	\$8
Stations with safety equipment		2	ea	\$2
Gondola Total				\$30 to \$35

Note: Cost estimate is based on unit costs from the Peak 2 Peak gondola in Whistler, BC, built in 2008

Figure 5.4: Potential Carson Valley/Lake Tahoe Gondola Route

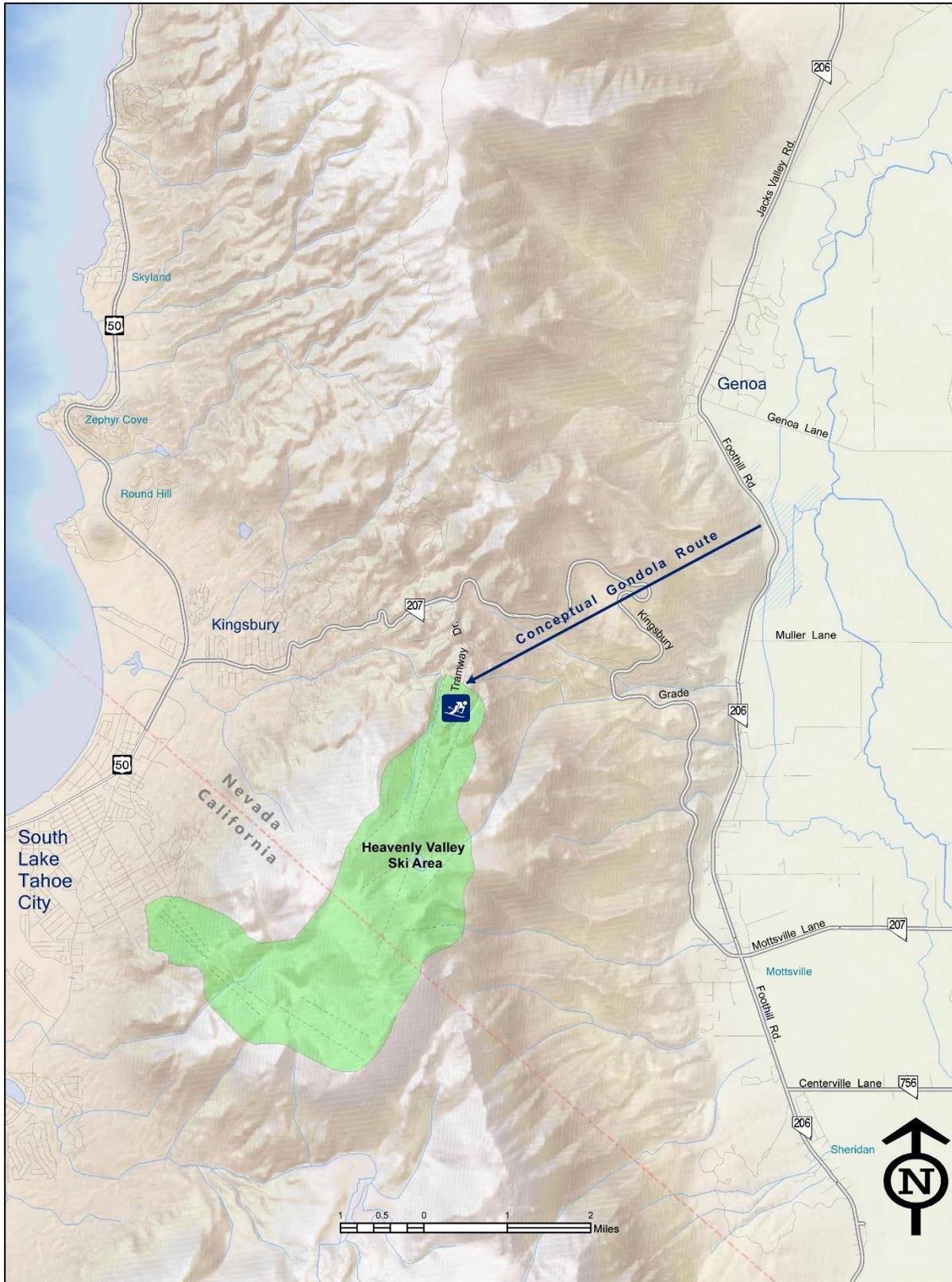

5.4.2 VIRGINIA AND TRUCKEE RAILROAD

The Virginia and Truckee (V&T) Railroad was originally incorporated in 1868, and by 1872 the railroad was in service from Virginia City to Carson City and on to Reno. In 1905, a new Virginia and Truckee Railway was incorporated to buy the assets of the V&T Railroad. This allowed the new V&T to build a 15-mile extension from Carson City south to Minden to serve the livestock and agricultural interests of the Carson Valley. The Dangbergs had considerable land holdings at the time and provided most of the right-of-way for the new extension. By 1906, the Carson City railroad shops had built an express and mail car for the new Minden Branch. Before there were paved roads, the V&T moved large numbers of cattle to the Carson Valley where they were fattened before being sent to slaughter. In the early 1920's, the State of Nevada constructed a paved highway (U.S. 395) from Reno to Minden, which started the decline of the V&T. In the 1940's, the V&T still had facilities for turning locomotives and entire trains in Minden, but by then the railroad was in serious financial trouble. The Minden Depot was featured briefly in the 1949 film *Chicken Every Sunday*, but the railroad's last revenue operating day was May 31, 1950. Removal and scrapping of the rails began almost immediately and was completed the same year. Large portions of the right-of-way were purchased by the state highway department, while other portions reverted to local ranchers.¹ Photocopies of the Virginia and Truckee Railway maps showing the railroad alignment from Minden to Carson City are provided in Appendix B.

The V&T resumed operation out of Virginia City in 1976, extending the track improvements as far as the Carson City border in 2009. It currently operates from May through October between Virginia City and Gold Hill. In recent years there has been interest in restoring operation of the V&T in the Carson Valley. In 2015, Manhard Consulting, LTD prepared the *Carson Valley/Eagle Valley Railroad Route Alignment Concepts Final Report* for Bently Enterprises, Douglas County and Carson City. This document provides potential rail alignments connecting Minden to Carson City, and also Genoa. Refer to Figure 5.5. Two alignments identified in the report provide options for light rail street cars in the Minden-Gardnerville area. The "Purple" line would connect to the main line at Heybourne Road and serve the Bently Campus area, while the "Cyan" line would serve the downtown area from Buckeye Road to Lampe Park. Key figures from the report that show potential future railway alignments in Douglas County are provided in Appendix B.

¹ Stephen E. Drew, *Nevada's Virginia & Truckee Railroad (Images of Rail)*, Charleston, South Carolina: Arcadia Publishing, 2014.

Figure 5.5: Carson Valley Proposed Railroad Alignments

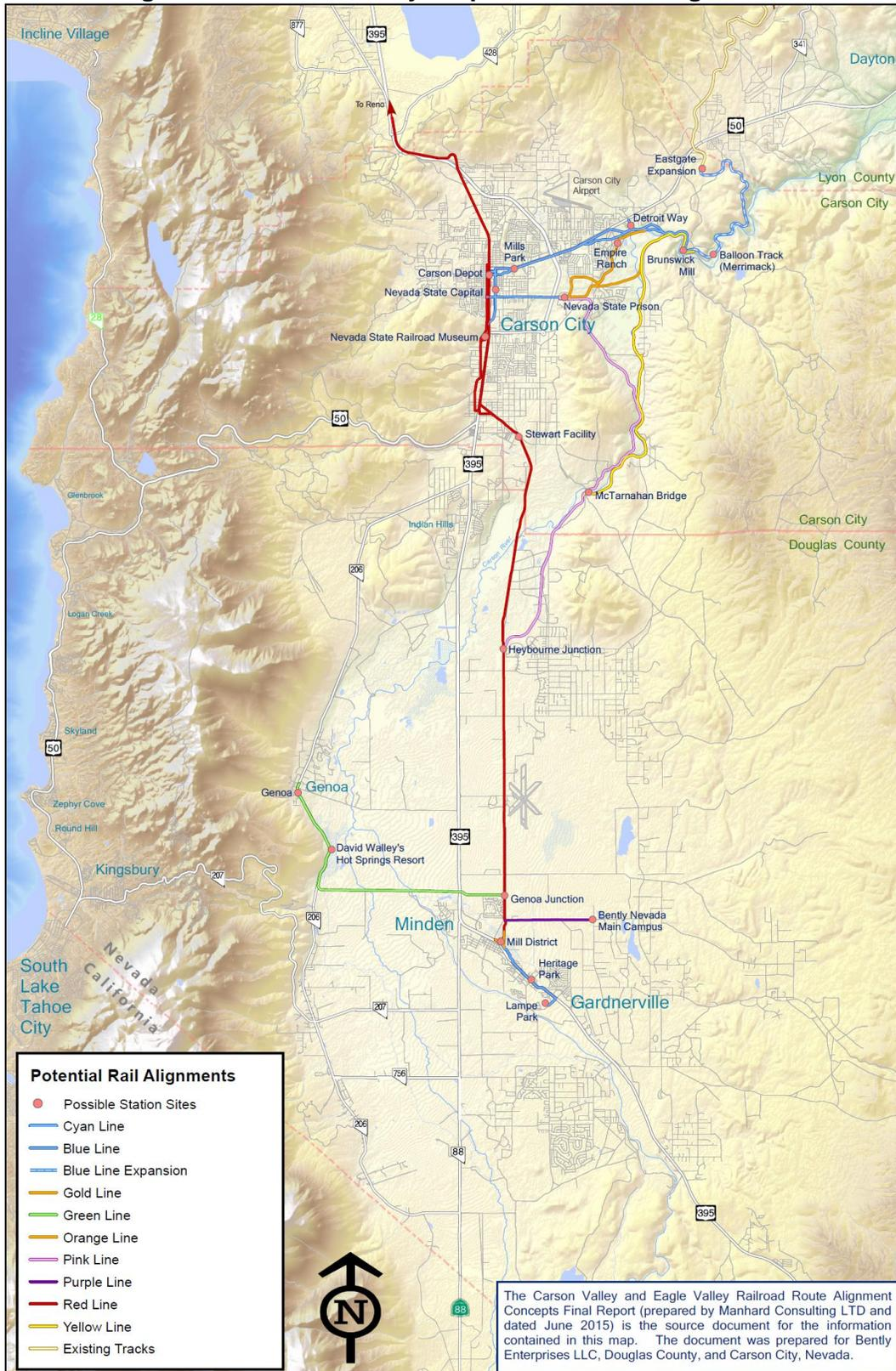



2017 Douglas County Transportation Plan

5.5 Public Transportation Policies

- 5.5.1 Provide general public transit service to Douglas County residents and visitors.
- 5.5.2 Provide transit services to the elderly and persons with disabilities, as required by the Americans with Disabilities Act.
- 5.5.3 Provide regional public transit, connecting Douglas County residents and visitors with Carson City, Washoe County and Alpine County (California).
- 5.5.4 Promote use of local and regional public transit serving Douglas County residents and visitors.
- 5.5.5 Develop public transit goals and objectives to measure the transit system performance.
- 5.5.6 Annually review performance measures and indicators for existing transit services and adjust services accordingly.
- 5.5.7 Prepare a short range transit plan by 2018, including a five-year transit project list, which identifies transit needs and potential service improvements along with a financial plan.
- 5.5.8 Establish and preserve a transportation corridor in the vicinity of the former Virginia & Truckee railroad right-of-way between Minden and the Carson City line, parallel to Heybourne Road.
- 5.5.9 Evaluate the feasibility of providing rubber-tire transit service to initially serve major travel destinations as development occurs along the Heybourne Road corridor. Identify potential private and public funding sources to establish and maintain service.

5.6 Public Transportation Financial Considerations

Douglas County operates the DART with funding from senior service agencies, transient occupancy tax collected outside the Lake Tahoe area, the Douglas County General Fund and various Federal Transit Administration grant programs.

The county will need to explore additional funding sources such as local sales tax, federal transit funds and partnerships with local businesses to expand services in the future. Development of a short range transit plan will aid this assessment by exploring transit services and funding options in more detail.

2017 Douglas County Transportation Plan

Chapter 6 BICYCLE/PEDESTRIAN/TRAILS ELEMENT

The *Douglas County Comprehensive Trails Plan* is a separate document identifying bicycle and pedestrian facilities, which is incorporated in its entirety into the *2017 Douglas County Transportation Plan*. The current version of this document is available on the Douglas County website.

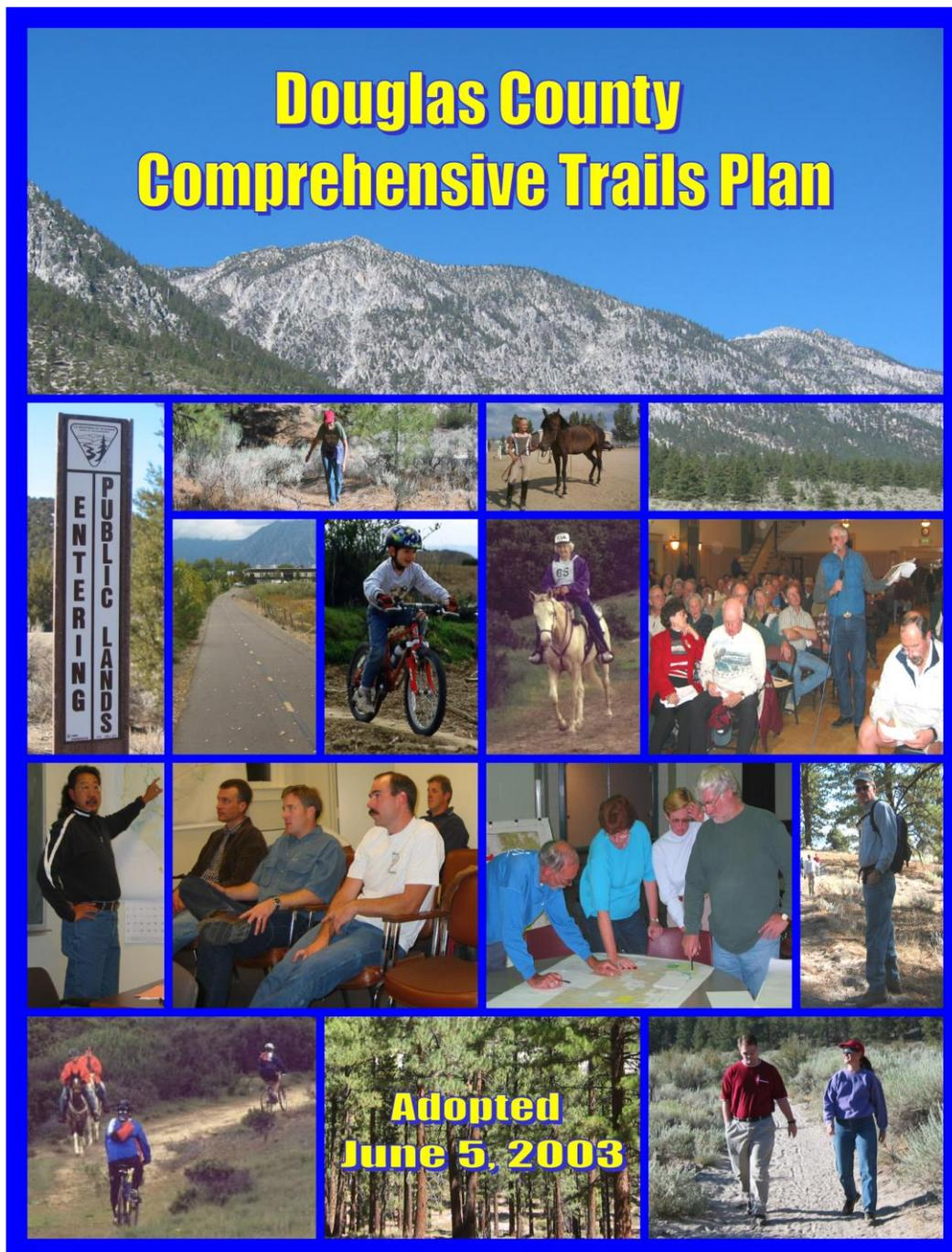



2017 Douglas County Transportation Plan

The *Douglas County Bicycle Plan* is a separate document identifying bicycle facilities, which is incorporated in its entirety into the *2017 Douglas County Transportation Plan*. This document supplements the bicycle information contained in the Douglas County Comprehensive Trails Plan. The current version of the *Douglas County Bicycle Plan* is available on the Douglas County website.

STATE OF NEVADA
DEPARTMENT OF TRANSPORTATION

DOUGLAS COUNTY **Bicycle Plan**

BIKE LANE

National Historic Trails
Auto Tour Route

PREPARED FOR: DOUGLAS COUNTY
SPONSORED BY: NDOT

| OCTOBER 2014

NEVADA DOT Kimley»Horn



6.1 Bicycle/Pedestrian/Trails Policies

- 6.1.1 Maintain and implement the adopted *Douglas County Comprehensive Trails Plan* to provide opportunity for non-motorized transportation within the county that meets both recreational and commuter needs.
- 6.1.2 Ensure development and maintenance of multi-purpose (hiking, equestrian, bikeway and off-road bicycle) trail systems throughout Douglas County, connecting with public lands and recreation facilities of local and regional interest.
- 6.1.3 Maintain and implement the *Douglas County Bicycle Plan*.

Chapter 7
AVIATION ELEMENT

The *Minden–Tahoe Airport Plan* is a separate document, which is incorporated by reference in its entirety into the *2017 Douglas County Transportation Plan*. The current version of this document is available on the Minden–Tahoe Airport website at www.mindentahoeairport.com. The Douglas County website has a link to the airport website.

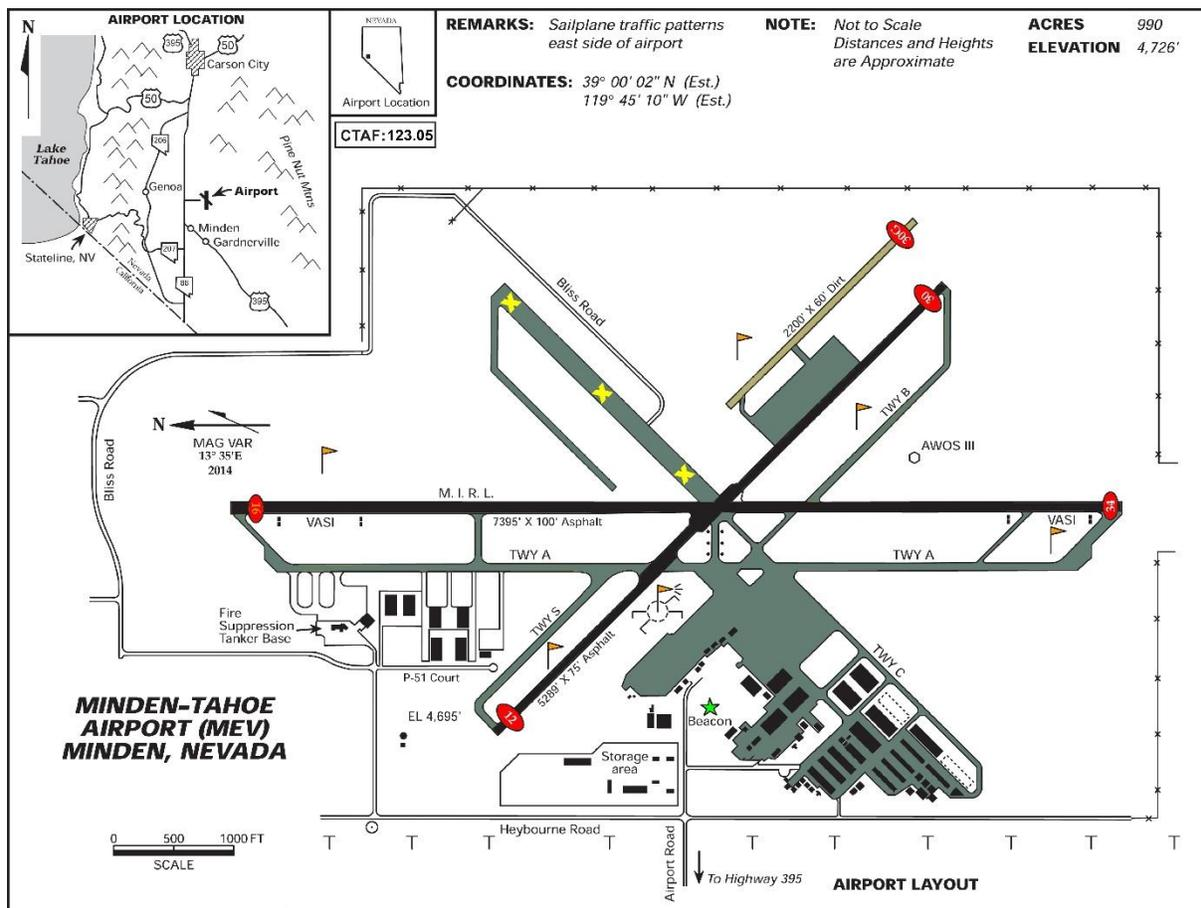



7.1 Aviation Policies

7.1.1 Provide for safe continuation and expansion of the Minden–Tahoe Airport.

7.2 Aviation Goals

The following are goals identified in the Minden-Tahoe Airport Master Plan (AP).

- AP Goal 1: Accommodate forecast operations in a safe and efficient manner.
- AP Goal 2: Ensure that future development will continue to accommodate a variety of general aviation activities.
- AP Goal 3: Enhance and facilitate soaring while maintaining and improving safety.
- AP Goal 4: Identify the best land use types for the landside development areas.
- AP Goal 5: Foster complementary development of Airport’s environs.
- AP Goal 6: Enhance the self-sustaining capability of the Airport and ensure the financial feasibility of airport development.
- AP Goal 7: Encourage the protection of existing public and private investment in land and facilities.



Chapter 8 FINANCIAL ELEMENT

8.1 Funding for Road Maintenance

There has been a shortfall in funding for road maintenance in Douglas County for many years. In recent years the county has taken the following steps toward increasing funding:

- In 2004, a ballot initiative to implement a \$0.05 gas tax failed.
- In 2011, the Board of Commissioners approved shifting \$191,000 annually in property tax revenue from the General Fund to the Road Operating Fund.
- In 2012, the Board of Commissioners approved a goal to shift \$140,000 per year in property tax revenue from the General Fund for five years, for a total of \$700,000 annually by fiscal year 2016/2017.
- In 2013, the Board of Commissioners used priority based budgeting to shift more than \$1,000,000 per year in property tax revenue from the General Fund to the Regional Transportation Fund for preventive maintenance.
- In 2013, the Board of Commissioners directed the county manager to create a Road Funding Task Force to identify solutions to road maintenance funding challenges.

In the fall of 2013, the county manager created a task force composed of 18 members of the public who were active in the community. Public Works Department staff provided technical assistance to the task force. The task force met on a monthly basis and made several presentations to the Board of Commissioners. Their final presentation to the board was on March 6, 2014. Potential funding options identified included:

- General Fund shift of existing county-wide property taxes
 - Board discretion/budget process
- Create new road general improvement districts (GID) to fund county local roads
 - NRS 318.0953
 - Would generate new property tax revenue from areas not currently in town or GID boundaries
- Utility operator fee
 - NRS 354.59881
 - 1 percent = \$800,000 per year
 - 2.5 percent available (1 percent every other year)
- Gas tax
 - NRS 373.030
 - \$0.05 per gallon = \$900,000 per year
 - May be phased in over time



2017 Douglas County Transportation Plan

- Infrastructure tax
 - NRS 377B.100
 - 1 percent = \$800,000 per year
 - 0.25 percent sales tax = \$1,500,000
- Public transit and road maintenance tax
 - NRS 377A.030
 - 0.50 percent sales tax = \$3,000,000 per year
 - Requires voter approval

At the meeting on March 6, 2014, the Board:

- Established a policy designating county-wide taxes to be used for regional/county roads and local taxes to be used for local/neighborhood roads.
- Directed staff to identify additional funding to be shifted to road maintenance for collector roads as part of the fiscal year 2014/2015 budget process.

On December 3, 2015, the Board of Commissioners approved Ordinance No. 2015-1446, increasing its county option motor vehicle fuel tax from \$0.04 to \$0.09 per gallon on gasoline and gasohol (NRS 373.030). On that date, the Board also held a second reading of Ordinance 2015-1445. This ordinance would have imposed an additional \$0.25 sales tax with an effective date of April 1, 2016, and generated \$1,500,000 annually for infrastructure use, including a portion for road maintenance and road construction projects. However, Ordinance 2015-1445 failed on its second reading.

8.2 Financial Policies

- 8.2.1 Coordinate with the NDOT to implement capital and operational improvements on state facilities in a timely manner.
- 8.2.2 Develop funding mechanisms to implement system-wide capacity and operational system improvements to the street and highway network.
- 8.2.3 Develop funding mechanisms to maintain the existing street and highway network.
- 8.2.4 Develop funding mechanisms to implement public transportation system improvements.
- 8.2.5 Develop funding mechanisms to implement improvements to the bicycle/pedestrian/trails system.
- 8.2.6 Develop funding mechanisms to implement improvements at the Minden–Tahoe Airport.
- 8.2.7 Explore the development and implementation of a traffic impact fee program to fund regional capacity improvements on the street and highway network.



2017 Douglas County Transportation Plan

- 8.2.8 Develop and maintain a coordinated transportation plan of proposed transportation facility improvements in collaboration with adjacent jurisdictions.
- 8.2.9 Construct and maintain necessary street and road facilities in rural and urban settings to maintain a high quality-of-life in Douglas County

8.3 Funding for Proposed Transportation Projects

The total cost for projects needed to maintain the current LOS standards on Douglas County and NDOT roads through 2040 is estimated at \$741,800,000 (refer to tables 4.9 and 4.10). The Plan does not assign responsibility for these costs to any particular entity. Funding will need to be established for each project on a case-by-case basis. It is likely that each project will have funding from multiple sources. Based on past experience, potential funding sources include NDOT, Douglas County, and developer contributions. Developer contributions could include construction of improvements and/or monetary contributions.

In addition to the projects needed to maintain LOS standards, the Plan also identifies projects that provide alternate local and regional access. These projects are estimated to cost \$814,500,000.

It is clear that the amount of funding required to implement the Plan is huge, and the County would need to contribute substantially to many of the projects. The County has not identified funding for construction of any of the capacity projects or alternate access projects identified in the Plan. This can be confirmed by a review of the current 5-Year Transportation Plan. To implement this Plan, the County must establish funding for the projects. Discussion of potential funding sources is beyond the scope of this document.

Chapter 9 LAKE TAHOE ELEMENT

Transportation planning in the Lake Tahoe basin involves many organizations, including the Tahoe Regional Planning Agency (TRPA)/Tahoe Metropolitan Planning Organization (TMPO), Tahoe Transportation District (TTD), Tahoe Douglas Transportation District (TDTD), and the South Shore Transportation Management Association.

The *Lake Tahoe Regional Plan* was prepared by the Tahoe Regional Planning Agency and approved in February 2013. It is a separate document that addresses transportation planning in the Lake Tahoe basin. The Regional Plan is incorporated by reference in its entirety into the *2017 Douglas County Transportation Plan*. The current version of the Regional Plan is available on the Tahoe Regional Planning Agency website.

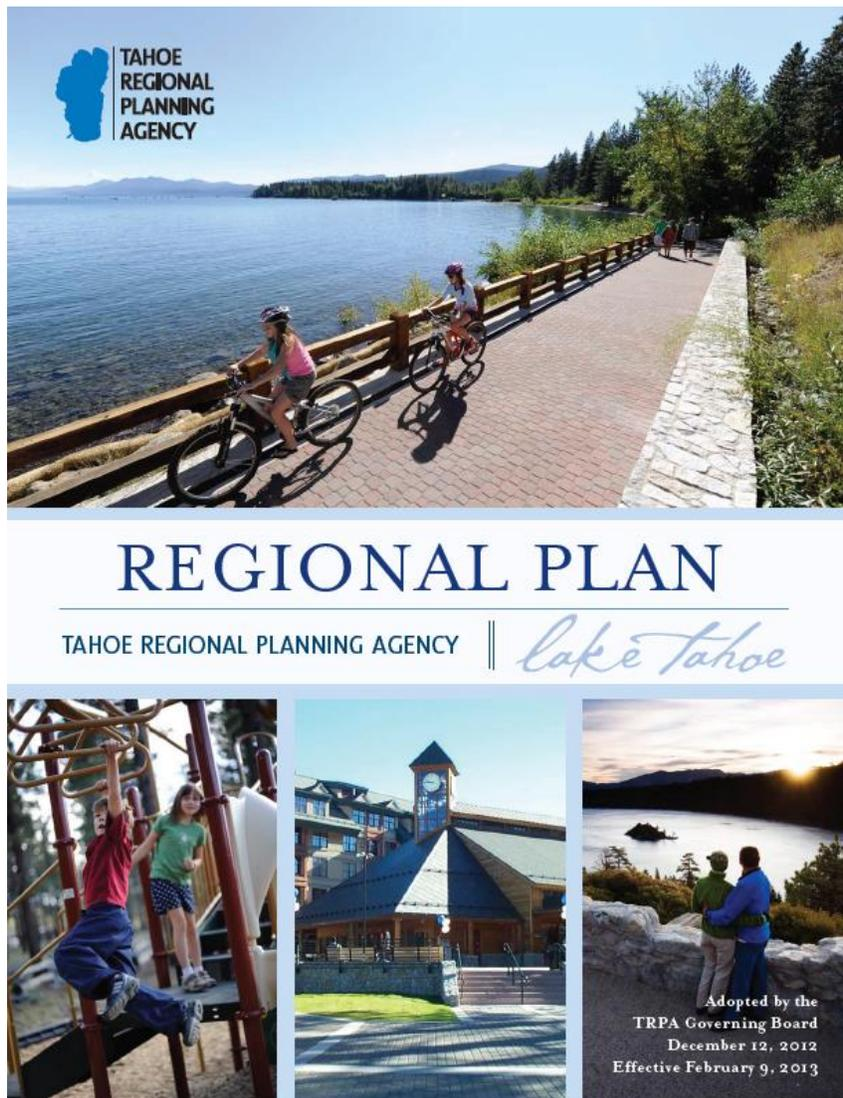



2017 Douglas County Transportation Plan

9.1 Lake Tahoe Transportation Policies

LT T Policy 1: Participate and support the planning, design and implementation of transportation projects and transit improvements at Lake Tahoe consistent with the Tahoe Revitalization initiative of the County Economic Vitality Plan and other needs identified through the annual update of the County 5-Year Transportation Plan, County Transportation Plan, and plans of the TRPA, TMPO and TTD.

9.2 Lake Tahoe Transportation Actions

LT T Action 1.1: Douglas County shall participate with the TTD, TMPO, NDOT, City of South Lake Tahoe, Caltrans, FHWA, Nevada State Parks, and private sector stakeholders in the planning, design and implementation of the U.S. 50 Stateline Corridor/South Shore Revitalization Program.

LT T Action 1.2: Douglas County shall continue to participate in efforts to complete the Nevada Stateline-to-Stateline Bikeway Project and other identified bicycle and multi-use trail projects within Douglas County at Lake Tahoe consistent with the Tahoe Revitalization and Tremendous Trails initiatives of the County Economic Vitality Plan.

LT T Action 1.3: Douglas County shall continue to participate in the planning and implementation of transit system improvements through its representation on the Tahoe Transportation District Board of Directors.

LT T Action 1.4: Through the Tahoe Transportation District, Douglas County shall continue to explore the feasibility and potential benefits of waterborne transit at Lake Tahoe that serves the County and further supports the Tahoe Revitalization and the South Shore Plan.

LT T Action 1.5: Douglas County shall continue to participate in the community based forum of the South Shore Transportation Management Association (SS/TMA). SS/TMA plays a lead role in the development of transportation demand management and strategies to mitigate the impact of highway construction projects and special events.



APPENDIX A

Douglas County/Carson City Travel Demand Model

Douglas County/Carson City Travel Demand Model

DRAFT REPORT

2017 Douglas County Transportation Plan

Prepared by

PARSONS

August 2017

CONTENTS

1. INTRODUCTION 1

2. DEMOGRAPHIC INFORMATION 4

 Zone Structure..... 4

 Demographic Forecasting Needs 4

 Base Year (2014) Socioeconomic Data Summaries 5

3. HIGHWAY NETWORK..... 8

 Network Development 8

 Transportation Analysis Zones and Highway Geographic Database 8

 Node Attributes 10

 Highway Network (.NET) Creation..... 10

 Turn Penalties Table 12

 Base Year Network Road Classification..... 12

 Highway Skims..... 14

4. TRIP GENERATION 15

 Resident Model Set..... 15

 Overview..... 15

 Socioeconomic Submodels 16

 Year 2000 Census Data..... 16

 Households by Household Size Disaggregation Submodel..... 17

 Households by Income Group Disaggregation Model..... 20

 Estimating Joint Distributions of Households by Socioeconomic Strata 22

 Socioeconomic Model Application Summary 23

 Trip Production Models 24

 Home-Based Work Trip Production Model..... 24

 Home-Based School Trip Production Model..... 24

 Home-Based Shop Trip Production Model..... 25

 Home-Based Other Trip Production Model..... 26

 Non-Home-Based Trip Production Model..... 26

 Trip Attraction Models 27

 Home-Based Work Trip Attraction Model 28

 Home-Based School Trip Attraction Model 28

 Home-Based Shop Trip Attraction Model 29

 Home-Based Other Trip Attraction Model 29

 Non-Home-Based Trip Attraction Model 29

 Special Generator Trip Attraction Models..... 29

5. TRIP DISTRIBUTION 30

 Introduction..... 30

 Gamma Function..... 31

 Source of Data..... 31

Douglas County/Carson City Regional Travel Demand Model

Calibration Process 31

 Friction Factor Parameters 32

 Travel Time Comparison 33

 Travel Time and Trip Length Frequency Distributions 34

 Trip Length Distribution Macro..... 40

6. MODE SPLIT 42

 Introduction..... 42

 Home-Based Auto Occupancy Models..... 43

 Home-Based Work Average Auto Occupancies..... 43

 Home-Based School Average Auto Occupancies..... 44

 Home-Based Shop Average Auto Occupancies 44

 Home-Based Other Average Auto Occupancies..... 44

 Non-Home-Based Auto Occupancy Models 45

7. TRIP ASSIGNMENT 47

 Production/Attraction to Origin/Destination and Time of Day Distribution 47

 Other Trips Matrix 47

 Traffic Assignment 49

 Cold Start Flows and VMT..... 50

 Feedback Looping..... 50

 Assignment Reports 50

 Traffic Assignment Validation 52

8. TRAVEL FORECAST MODEL APPLICATION 65

9. FUTURE FORECASTS 70

APPENDIX A: Input Files, Output Files, and Parameters

APPENDIX B: 2014 Land Use Data

APPENDIX C: Douglas County and Carson City Industries and Travel Demand Model
Employment Category

LIST OF FIGURES

Figure 1-1: Douglas County/Carson City Model Flow Chart (1 of 2)..... 2

Figure 2-1: Douglas County and Carson City Transportation Analysis Zone Map 6

Figure 2-2: External Gateway Locations for the Travel Demand Model 7

Figure 3-1: Year 2014 Douglas County and Carson City Highway Network 13

Figure 4-1: Household Size Disaggregation Submodel..... 18

Figure 4-2: Income Group Disaggregation Submodel..... 22

Figure 5-1: Friction Factor Parameters—Home-Based Work 32

Figure 5-2: Friction Factor Parameters—Other Trip Purposes..... 33

Figure 5-3: Home-based Work Travel Time Comparison 34

Figure 5-4: Travel Time Frequency Distributions—Home-Based Work Trips..... 35

Figure 5-5: Trip Length Frequency Distributions—Home-Based Work Trips 35

Figure 5-6: Home-Based School Trips – Frequency Distribution 36

Figure 5-7: Home-Based Shop Trips – Frequency Distribution 37

Figure 5-8: Home-Based Other Trips – Frequency Distribution 38

Figure 5-9: Non-Home Based Trips – Frequency Distribution 39

Figure 6-1: Non-Home-Based Average Auto Occupancy Calibration Data and Model . 46

Figure 7-1: Screenline Locations in Carson City..... 54

Figure 7-2: Screenline Locations in Douglas County 55

Figure 8-1: Daily Level of Service on Various Facilities 68

Figure 8-2: Year 2014 Existing Daily Traffic Volumes 69

Figure 9-1: Year 2025 Level of Service on the Existing Roadway Network
plus Vista Grande Extension..... 71

Figure 9-2: Year 2025 Traffic Volumes on the Existing Roadway Network
plus Vista Grande Extension..... 72

Figure 9-3: Year 2025 Traffic Volumes on the Existing Roadway Network plus
Mid-term Projects—Vista Grande Extension, Waterloo Lane Extension
and Heybourne Road from Johnson Lane to Stephanie Way 73

Figure 9-4: Year 2040 Level of Service on the Existing Roadway Network
plus Vista Grande Extension and Heybourne Road from Buckeye Lane
to Stephanie Way 74

Figure 9-5: Year 2040 Traffic Volumes on the Existing Roadway Network
plus Vista Grande Extension and Heybourne Road from Buckeye Road
to Stephanie Way 75

Figure 9-6: Year 2040 Traffic Volumes on the Existing Roadway Network plus
Mid-term and Long-term Projects—Vista Grande Extension and
Waterloo Lane Extension..... 76

LIST OF TABLES

Table 2-1: Location of External Gateways in the Travel Demand Model..... 4

Table 2-2: Douglas County/Carson City Socioeconomic Data for 2014..... 7

Table 3-1: Network Attributes 9

Table 3-2: Hourly Capacities (vehicles per hour per lane) Used for the Travel Demand Model 11

Table 3-3: Free-Flow Speeds (miles per hour) Used for the Travel Demand Model 11

Table 3-4: Facility Type and Area Type Classification in the Travel Demand Model ... 11

Table 4-1: Douglas County and Carson City—2000 Census Data Summary 17

Table 4-2: Douglas County and Carson City—2014 Data Summary..... 17

Table 4-3: Household Size Disaggregation Submodel 19

Table 4-4: Household Income Classification..... 20

Table 4-5: Income Group Disaggregation Submodel 21

Table 4-6: Households by Income Group and Household Size..... 23

Table 4-7: Proportion of Households by Income Group and Household Size 23

Table 4-8: Home-Based Work Trip Production Model 24

Table 4-9: Home-Based School Trip Production Model 25

Table 4-10: Home-Based Shop Trip Production Model 25

Table 4-11: Home-Based Other Trip Production Model 26

Table 4-12: Non-Home-Based Trip Production Model 26

Table 4-13: Land Use Types and Explanatory Variables for Trip Attraction Rates 27

Table 4-14: Trip Attraction Models 28

Table 5-1: Final Friction Factor Parameters—Home-Based Work 32

Table 5-2: Final Friction Factor Parameters—Other Trip Purposes..... 33

Table 5-3: Trip Distribution Calibration Results—Home-Based Work Trips by Income Group 40

Table 5-4: Trip Distribution Calibration Results—Non-Work Trip Purposes 40

Table 5-5: Trip Length Distribution Table (tldtable.bin)..... 41

Table 6-1: Home-Based Work Average Auto Occupancy Model 43

Table 6-2: Home-Based School Average Auto Occupancy Model 44

Table 6-3: Home-Based Shop Average Auto Occupancy Model 44

Table 6-4: Home-Based Other Average Auto Occupancy Model 45

Table 7-1: Departure and Return Percentages by Time of Day and Trip Purpose (Diurnalscalibrated_final. bin)..... 48

Table 7-2: Time Period Flow Table (FLOW_AMPEAK.BIN, FLOW_PMPEAK.BIN.BIN and FLOW_OFFPEAK.BIN) 51

LIST OF TABLES *(continued)*

Table 7-3: Results Table (Summaryresults.bin)	52
Table 7-4: Functional Class Results Table (FuncclassResults.bin)	52
Table 7-5: 2014 Validation—Daily Volumes Comparisons to Counts	56
Table 7-6: 2014 Validation—AM Peak Volumes Comparisons to Counts	57
Table 7-7: 2014 Validation—PM Peak Volumes Comparison to Counts	58
Table 7-8: Vehicle Miles Traveled and Vehicle Hours Traveled by Time Period— All Jurisdictions (2014)	59
Table 7-9: Vehicle Miles Traveled and Vehicle Hours Traveled by Time Period— Carson City (2014).....	61
Table 7-10: Vehicle Miles Traveled and Vehicle Hours Traveled by Time Period— Douglas County (2014).....	63
Table 8-1: Level of Service Thresholds Used for LOS Calculations	65
Table 8-2: Summary of the Daily Level of Service on Various Facilities.....	66
Table 9-1: Douglas County/Carson City Historic Growth Rates for 2025	70
Table 9-2: Douglas County/Carson City Historic Growth Rates for 2040	70

Douglas County/Carson City Regional Travel Demand Model

1. INTRODUCTION

This document describes the estimation and validation of the Douglas County/Carson City Model that was developed for the counties of Douglas and Carson City in northern Nevada.

The Douglas County/Carson City Travel Demand Model (hereafter referred to as Travel Demand Model) represents an evolution of travel forecasting models and model components previously developed for Carson City and Douglas Counties.

Prior to the completion of the model calibration described in this document, a significant effort was undertaken to improve the accuracy of the planning variable database, particularly with regard to households and employment variables. This re-estimation of base year planning variables was undertaken for the 2014 timeframe based on a detailed accounting of dwelling units—available from the County Assessor’s office, and employer records—available from the Nevada Department of Employment, Training and Rehabilitation.

The Travel Demand Model covers the two counties of Douglas and Carson City. The Travel Demand Model has seven gateways representing the major roadways in and out of these two counties. The illustration which follows (Figure 1-1) provides a flow chart of the overall model structure.

The Douglas County/Carson City Travel Demand Model is designed to operate with TransCAD software, which is used by the Nevada Department of Transportation for planning projects throughout the state. TransCAD is a geographic information system (GIS) designed specifically for use by transportation professionals to store, display, manage, and analyze transportation data. TransCAD combines GIS and transportation modeling capabilities into a single integrated platform that can be used for all modes of transportation, at any scale or level of detail. TransCAD provides:

- A powerful GIS engine with special extensions for transportation
- Mapping, visualization, and analysis tools designed for transportation applications
- Application modules for routing, travel demand forecasting, public transit, logistics, site location, and territory management

TransCAD is a GIS that can be used to create and customize maps, build and maintain geographic data sets, and perform many different types of spatial analysis. TransCAD includes sophisticated GIS features such as polygon overlay, buffering, and geo-coding, and has an open system architecture that supports data sharing on local- and wide-area networks.

Douglas County/Carson City Regional Travel Demand Model

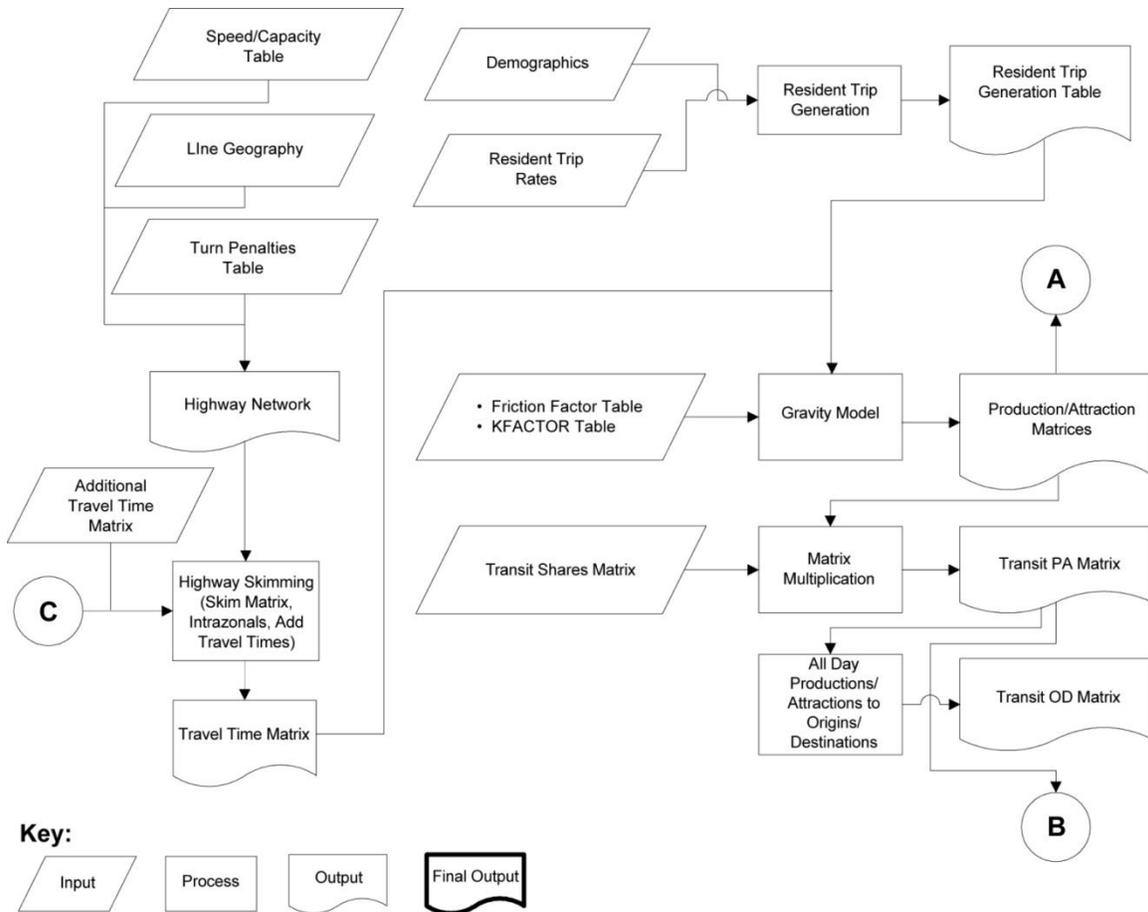

Figure 1-1: Douglas County/Carson City Model Flow Chart (1 of 2)

Douglas County/Carson City Regional Travel Demand Model

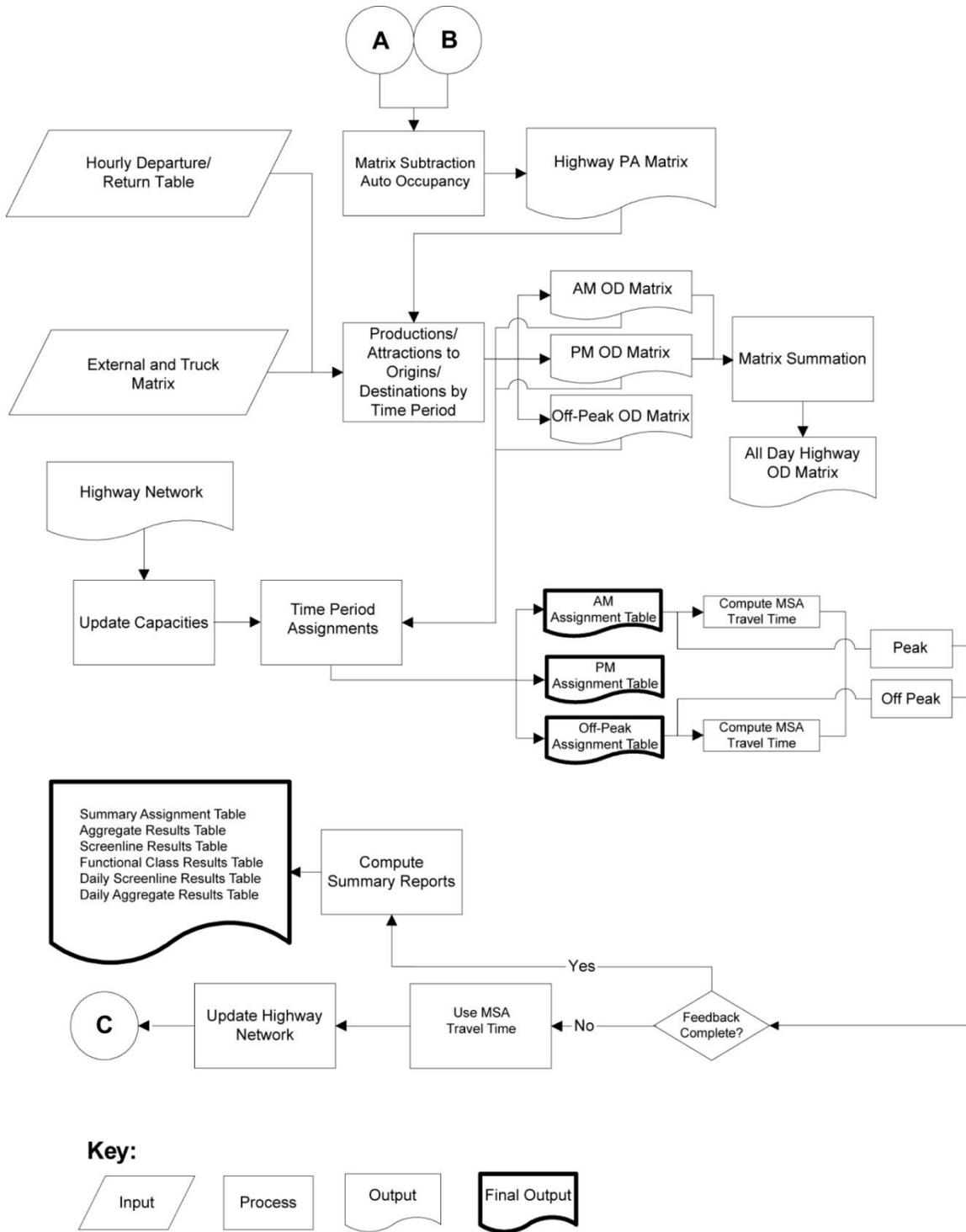

Figure 1-1: Douglas County/Carson City Model Flow Chart (2 of 2)

2. DEMOGRAPHIC INFORMATION

Zone Structure

The entire counties of Douglas and Carson City are currently being modeled by the Travel Demand Model. The Travel Demand model is subdivided into 324 internal transportation analysis zones (TAZ) and seven external stations for travel demand forecasting purposes. The resulting 331 zones are used for all travel demand forecasts.

External stations have been defined for all major roadways crossing the two counties. The following table 2-1 shows the location of the seven external stations.

Table 2-1: Location of External Gateways in the Travel Demand Model

GATEWAY/TAZ #	ROADWAY	LOCATION
1	U.S. 50	Located on the east end of Carson City
2	Goni Road	Located on the north end of Carson City
3	U.S. 395	Located on the north end of Carson City
4	Highway 28	Located on the west end of Carson City
5	U.S. 50	Located on the west end of Carson City
6	Highway 88	Located on the south end of Douglas County
7	U.S. 395	Located on the south end of Douglas County

Demographic Forecasting Needs

Travel models require a number of data items to be counted or estimated for each TAZ in the region. These items are as follows:

- **Occupied Households** are the occupied dwelling units in each TAZ. Vacant dwelling units and group quarters are not included in the household projections. “Vacant dwelling units” are determined using two variables, one representing “occupied households” and the other representing “dwelling units.” The 2010 U.S. Census information produces both of these variables. The difference between these two numbers provides the number of vacant dwelling units. Households by TAZ are the primary data used to estimate trip productions.
- **Population in Households** is used in conjunction with household data to estimate average household size for each TAZ. Population in group quarters is not included in the household population projections. Population in households is used in conjunction with households to estimate average household size for each TAZ and distributions of households by household size.
- **Median Household Income for each TAZ** has been summarized from the 2010 Census data and is expressed in 1999 dollars. This data is used to estimate distributions of households by income group for the modeling process. Income level is a strong explanatory variable for trip generation.
- **Hotel Employment** is defined as employment in the hotel industry, which is one of the planning variables in the model. Employment is defined at the work location; thus, one worker from a household might be counted as two employees if that worker held multiple

Douglas County/Carson City Regional Travel Demand Model

jobs. It is not possible to determine if a worker held more than one job using current U.S. Census data. All employment information is based on the data provided by the employer.

- ***Industrial Employment*** is defined as employment in the manufacturing industry. It includes employment in categories such as mining, manufacturing and transportation. Employment is defined at the work location. The employees are defined at the work location.
- ***Office Employment*** includes employment in finance and real estate, personal services, business services, and government. As with industrial employment, employees are defined at the work location.
- ***Retail Employment*** is defined as employment in the retail industry and includes shopping malls and specialty stores. The Retail Employment category is further subdivided into Retail-Shops, Commercial-Shops and Other-Retail. As with basic industrial employment, employees are defined at the work location.
- ***Other Non-retail Employment*** is defined as employment in the non-retail industry, like hospitals, service/industry, etc. As with basic industrial employment, employees are defined at the work location.
- ***Elementary and Middle School Enrollment (F18)*** is the student enrollment at public and private elementary and middle schools. Enrollment is defined at the school location.
- ***High School Enrollment (F912)*** is the student enrollment at public and private high schools. Enrollment is defined at the school location.
- ***College Enrollment (F13)*** is the student enrollment at public and private colleges. Both part-time and full-time students are included. Enrollment is defined at the school location.

In addition to the above data items, the number of internal-external vehicle trips at each external station is projected. The internal-external trips include all trips inbound to the study area and outbound from the study area, but exclude all through trips (not stopping in the study area). Through trips, being a very small percentage of all the external trips, are not specified in the model. The estimates of internal-external trips included with the Travel Demand Model are consistent with existing counts for the base year. Estimates of future year internal-external trips were developed based on population growth for that appropriate year.

Base Year (2014) Socioeconomic Data Summaries

The base year data for households was obtained from the County Assessor's office and city records. This information at the parcel level was aggregated to the TAZ level for the Carson City and Douglas County area. Year 2014 Department of Employment, Training, and Rehabilitation (DETR) data for employment information was obtained from the Nevada DETR. Median household income data from the Year 2000 Census data at the block group level was appropriately distributed at the TAZ level.

The Travel Demand Model was divided into three jurisdictions based on county boundaries as shown in Figure 2-1. Table 2-2 reports the base year summaries by jurisdictions. Jurisdiction 1 represents Carson City, Jurisdiction 2 represents Douglas County, and Jurisdiction 3 represents the external stations.

Douglas County/Carson City Regional Travel Demand Model

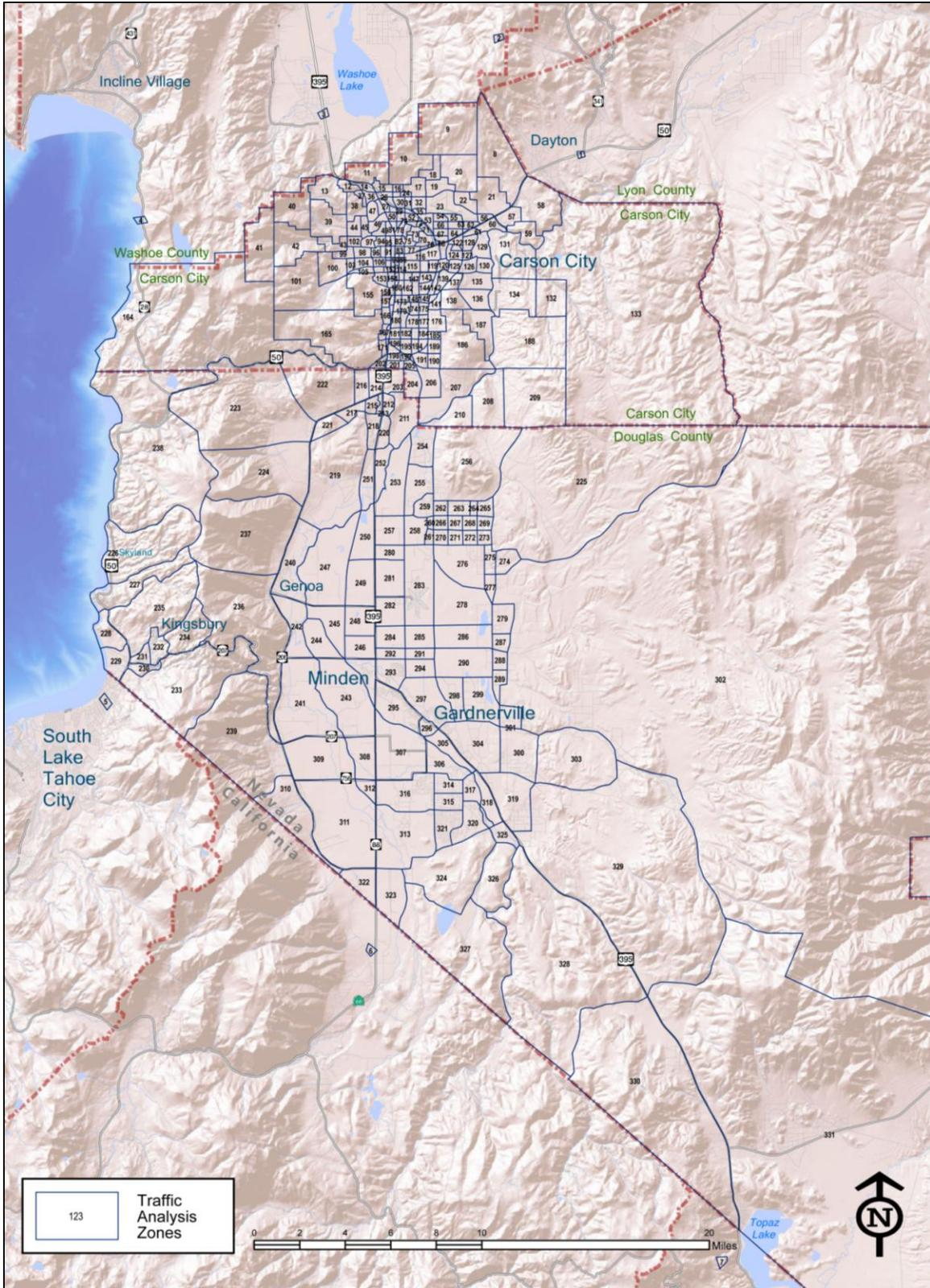

Figure 2-1: Douglas County and Carson City Transportation Analysis Zone (TAZ) Map

Douglas County/Carson City Regional Travel Demand Model

Table 2-2: Douglas County/Carson City Socioeconomic Data for 2014

JURISDICTION	ID	POP	DWELLING UNITS	OCCUPIED DWELLING UNITS	TOTAL EMPLOYMENT	HOTEL	OFFICE	INDUS
Carson City	1	55,163	23,487	21,381	29,937	186	11,136	4,651
Douglas County	2	46,916	23,629	19,603	19,761	3,283	3,953	3,590
Total		102,079	47,116	40,984	49,698	3,469	15,089	8,241

JURISDICTION	ID	RETAIL	NON-RETAIL	ELEMENTARY AND MIDDLE SCHOOL	HIGH SCHOOL	COLLEGE
Carson City	1	5,592	8,372	5,695*	2,574*	3,151*
Douglas County	2	4,146	4,789	5,144*	1,785*	705*
Total		9,738	13,161	10,839*	4,359*	3,8568

*Data is from year 2005. No data is available for year 2014.

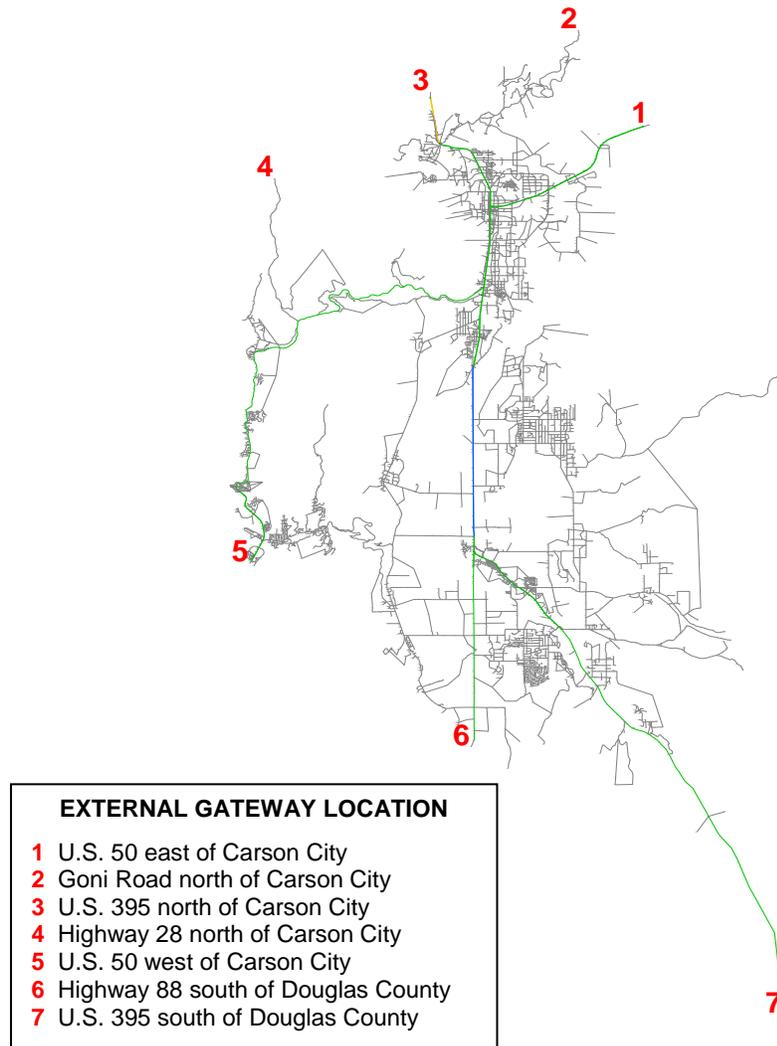
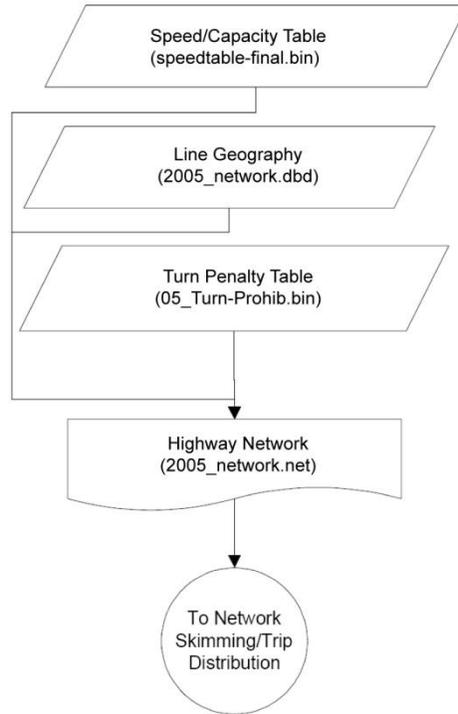

Figure 2-2: External Gateway Locations for the Travel Demand Model

3. HIGHWAY NETWORK

Network Development



Transportation Analysis Zones and Highway Geographic Database

Both the highway network and the transportation analysis zones (TAZ) are based on a 331 zone structure. Of these zones, zone numbers 1 to 7 are external zones and zone numbers 8 to 331 are internal zones. The TAZ geography is included as a TransCAD geographic database in the model. However, this database is not used in any model run. The TAZ geography exists so that users can link model inputs and outputs (e.g. demographics and output trips) to the files and view results geographically. TransCAD uses the zone network in conjunction with the highway network to assign trips from the zones to the highways.

The highway network is represented as a GIS geographic file. Both the attributes and the geography of the network are maintained in the TransCAD GIS. The geographic file uses shaping between nodes to accurately define both the true geography and true distances of the network links. The geographic shape of the street segments are derived from the Carson City and Douglas County GIS streets file, aerial images and TIGER/Line files.

Network attributes include roadway classification type, area classification types, segment lengths and other road design-based attributes which are used for classification of free-flow speeds and capacities. Another set of attributes are free flow speed, alpha, beta and capacity exceptions for individual links, which can be used to override the default values that are applied on a global basis. These values are variables used in the trip distribution equations. A full listing of the network attributes is listed in Table 3-1.

Douglas County/Carson City Regional Travel Demand Model

Table 3-1: Network Attributes

FIELD_NAME	DESCRIPTION
ID	* unique Link Identification Number
Length	* Length of the link in miles
Dir	* one-way or 2-way links (Dir 0 = 2-way link, Dir 1 = 1-way link)
NAME	* Street Name
FTYPE_NUM	* Integer form of the Functional Class of a link
FTYPE_NAME	* Type of Functional Class
ATYPE_NUM	* Integer form for Area Type
ATYPE_NAME	* Description of Area Type (i.e. suburban, rural, etc.)
AB_LANES	* Number of Lanes on AB Direction of Link
BA_LANES	* Number of Lanes on BA Direction of Link
UNIT	* Must have a Value of 1
DAY_LANE_CAP	Daily Capacity per Lane
HOUR_LANE_CAP	Hourly Lane Capacity
AB_SPEED	Free-flow Speed on AB Direction of Link (mi/hr)
BA_SPEED	Free-flow Speed on BA Direction of Link (mi/hr)
ALPHA	BPR Coefficient
BETA	BPR Exponent
ALT_BETA	Alternative BPR Coefficient for a link
ALT_CAP	Alternative Capacity for a link
ALT_SPEED	Alternative Speed for a link
AB_TIME	Free Flow Travel Time in AB Direction of Link (computed as Length/AB_SPEED * 60)
BA_TIME	Free Flow Travel Time in BA Direction of Link (computed as Length/BA_SPEED * 60)
AB_TIME_PK	For First Iteration =*Time, else time is AMPEAK
BA_TIME_PK	For First Iteration =*Time, else time is AMPEAK
AB_TIME_OPK	For First Iteration =*Time, else time is OFFPEAK
BA_TIME_OPK	For First Iteration =*Time, else time is OFFPEAK
AB_TIME_AVG	For First Iteration =*Time, else Weighted Average of (AMPEAK, PMPEAK & OFFPEAK)
BA_TIME_AVG	For First Iteration =*Time, else Weighted Average of (AMPEAK, PMPEAK & OFFPEAK)
AB_HR_CAP	One Hour Link Capacity
BA_HR_CAP	One Hour Link Capacity
AB_10HR_CAP	Offpeak Capacity is equal to 10* Hour Link Capacity
BA_10HR_CAP	Offpeak Capacity is equal to 10* Hour Link Capacity
AB_DAY_CAP	Daily Link Capacity
BA_DAY_CAP	Daily Link Capacity
AB_COUNT_AMPeak	** am peak hour Counts
BA_COUNT_AMPeak	** am peak hour Counts
AB_COUNT_PMPeak	** pm peak hour Counts
BA_COUNT_PMPeak	** pm peak hour Counts
AB_COUNT_OffPeak	** offpeak period Counts
BA_COUNT_OffPeak	** offpeak period Counts
AB_COUNT_Daily	** Daily Counts
BA_COUNT_Daily	** Daily Counts
SCREENLINE	** 1 indicates the link will be used for hourly count calculations
JURISDICTIONS	Jurisdiction boundaries
KFACTOR_DISTRICTS	kfactor districts based on links
CFCC	
FID_COUNTY	
COUNTY_NAME	
STATE_NAME	
STATE_FIPS	
CNTY_FIPS	
FIPS	

Douglas County/Carson City Regional Travel Demand Model

FIELD_NAME	DESCRIPTION
NDOT_ID2014	
STN_DIVIDED	
LKTYPE	
COUNTER	
NDOT_DIR	
STN_ID_DKS	
STN_LOCATION	
STN_ROADWAY	
STN_NUMBER	
AADT_2013	
AADT_2014	
AB_NDOT_3DAY_AMPeak	
BA_NDOT_3DAY_AMPeak	
TOT_NDOT_3DAY_AMPeak	
AB_NDOT_3DAY_PMPeak	
BA_NDOT_3DAY_PMPeak	
TOT_NDOT_3DAY_PMPeak	
AB_NDOT_3DAY_OffPeak	
BA_NDOT_3DAY_OffPeak	
TOT_NDOT_3DAY_OffPeak	
AB_NDOT_3DAY_Daily	
BA_NDOT_3DAY_Daily	
TOT_NDOT_3DAY_Daily	

Field names denoted with a “*” are required fields for the model. Field names denoted with a “**” are required only in the model option that compares count information with model flow results.

The highway network also contains 2014 traffic counts compiled by Parsons that were obtained primarily from NDOT. Both hourly and daily 2014 base year Annual Average Daily Traffic (AADT) counts were taken. This data was entered into the highway network input files for model validation, providing a comparison between counts and model forecasts. For more information, see page A-1 of Appendix A in the traffic model report. All hourly counts are based on 2014 estimates and only weekday counts were included.

Node Attributes

In TransCAD, nodes are an additional layer in the highway geographic database with unique ID's and optional attribute fields. In the Travel Demand Model, the first 331 node IDs are designated as the centroids. There is also a field in the nodes called “TAZ” that has the traffic analysis zone number for centroids nodes.

Highway Network (.NET) Creation

From this line geographic file, a TransCAD network is created. The network uses the fields LENGTH, FTYPE_NUM, *TIME, *_HR_CAPACITY, *10HR_CAPACITY, ALPHA, and BETA. Centroids have also been set in this network. The model includes a button that automatically recreates the highway network. The model also has a supplementary input file (speed-capacity lookup table), which is used to help create the network. The values of this speed-capacity lookup table are documented in Tables 3-2 and 3-3. Table 3-4 represents the cross-classification lookup value for the Facility and Area types

Douglas County/Carson City Regional Travel Demand Model

Table 3-2: Hourly Capacities (vehicles per hour per lane) Used for the Travel Demand Model

FUNCTIONAL CLASS	AREA TYPES		
	CENTRAL BUSINESS DISTRICT (CBD)	URBAN	RURAL
System ramps	2,000	2,000	2,000
Minor arterials	600	700	800
Major arterials	700	800	900
Ramps	1,600	1,600	1,600
Interstates	2,000	2,000	2,000
Freeways	2,000	2,000	2,000
Expressways	1,100	1,200	1,400
Collectors	500	600	700
Externals	99,999	99,999	99,999

Table 3-3: Free-Flow Speeds (miles per hour) Used for the Travel Demand Model

FUNCTIONAL CLASS	AREA TYPE		
	CBD	URBAN	RURAL
System ramps	40	45	50
Minor arterials	30	35	45
Major arterials	35	45	50
Ramps	20	30	40
Interstates	50	55	60
Freeways	50	55	60
Expressways	45	50	55
Collectors	25	35	40
Externals	50	50	50

Table 3-4: Facility Type and Area Type Classification in the Travel Demand Model

FUNCTIONAL CLASS	FACILITY	CBD	URBAN	RURAL
System ramps	1	1	2	3
Minor arterials	2	1	2	3
Major arterials	3	1	2	3
Ramps	4	1	2	3
Interstates	5	1	2	3
Freeways	6	1	2	3
Expressways	7	1	2	3
Collectors	8	1	2	3
Centroids	9	6	6	6
Externals	0	99	99	99

Douglas County/Carson City Regional Travel Demand Model

The speed-capacity lookup table automatically fills in link speeds, hourly and daily lane capacities and link alpha and beta values by functional classification and area type. By matching up the FTYPE_NUM and ATYPE-NUM fields in the network with this lookup table, the model automatically fills in the following fields: DAY_LANE-CAP, HOUR_LANE_CAP, AB_SPEED, BA_SPEED, AB_TIME, BA_TIME, ALPHA, BETA, AB_HR_CAP, BA_HR_CAP, AB_10HR_CAP, BA_10HR_CAP, AB_DAY_CAP and BA_DAY_CAP. The model also uses the fields AB_LANES, BA_LANES and UNIT as inputs network fields. Appendix A describes all of the fields in this table.

Turn Penalties Table

A turn penalties file is also included within the model stream. The turn penalties file is based on nodes and reflects, on a from-link to to-link basis, prohibitions and delays from certain turn movements from occurring during the traffic assignment process. The turn penalties are embedded into the network during network creation and affect the highway skimming and highway assignment sections of the model. Skim is a unit of measurement (time, distance, cost, etc.) between two TAZ. The following table describes the fields of the table:

Turn Penalties Table (xx_Turn-Prohib.bin)*

Field	Description
FROM_ID	From Link ID
TO_ID	To Link ID
PENALTY	Penalty Value, missing value denotes a prohibition

Base Year Network Road Classification

Figure 3-1 illustrates the classification of roadways coded in the Year 2014 Highway Network. The roadway network was developed from scratch using the TIGER files as a starting point and refining the roadway classifications as appropriate. This roadway network along with the roadway classification was used for the model development and validation purposes. Because of the technical requirements of the travel demand model, this map shows a slightly different functional classification network than the Douglas County map.

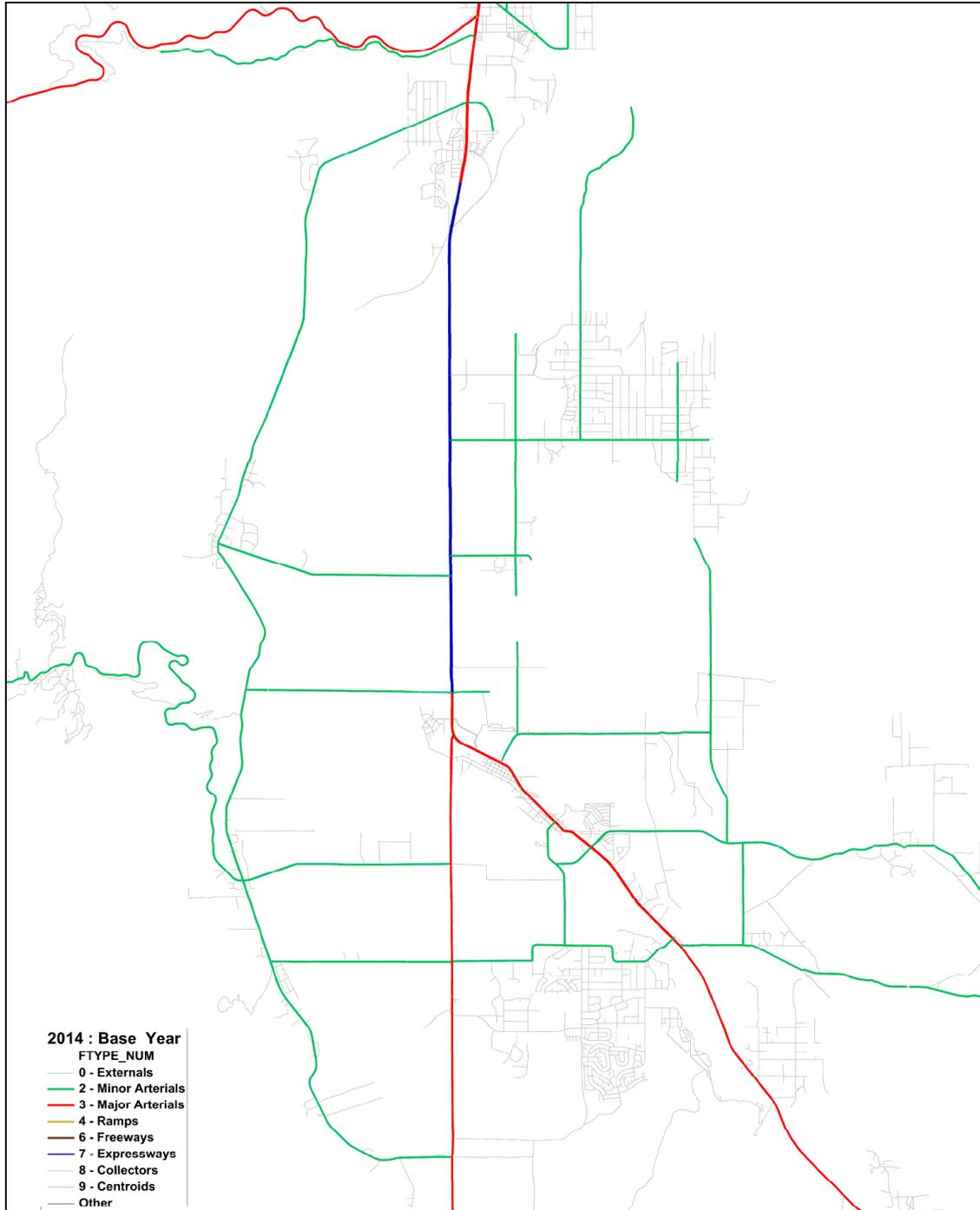
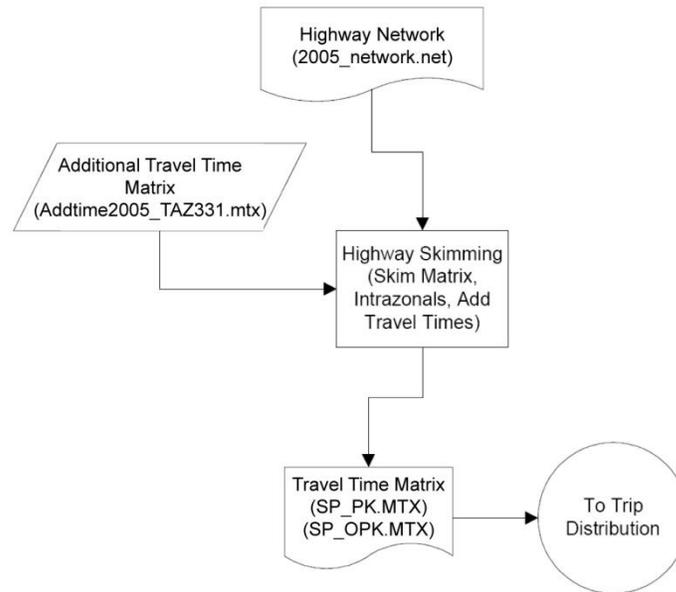

Figure 3-1: Year 2014 Douglas County and Carson City Highway Network

Highway Skims



Once the highway network is created, the model performs highway skims from centroid node to centroid node. The travel time is “minimized” and travel distance is skimmed. Both the offpeak and peak travel periods (8:00–9:00 a.m. and 5:00–6:00 p.m.) are skimmed as input to the downstream models. To calculate the offpeak skims, free-flow travel times are used, which are derived from the formula: $\text{GIS Length/Free-Flow Speed} * 60$. To calculate the peak skims, congested travel times are used. Congested travel times are calculated from the output of previous traffic assignments and are described in more detail in the Assignment section of this document.

After the peak and offpeak travel time matrices are calculated, intrazonal travel times are calculated and then origin and terminal times are added to them. The procedure used for calculating intrazonal travel times was the closest neighbors approach. For each row origin, the travel time to its two closest neighbors is found from the matrix. The intrazonal time is computed as one half of the travel time to its closest neighbor.

After intrazonal travel times are estimated, additional origin and terminal times of 4 minutes are added to the skim matrix.

The highway skims proceed in the following manner:

1. The highway database and network are opened and nodes that are centroids are selected.
2. A travel time matrix from centroid to centroid is calculated using the peak and offpeak skims.
3. Intrazonal times taking into account nearest adjacent neighbor times are calculated.
4. Origin and terminal times are added to the matrix.

Descriptions of the input and output files and parameters can be found in Appendix A.

4. TRIP GENERATION

Resident Model Set

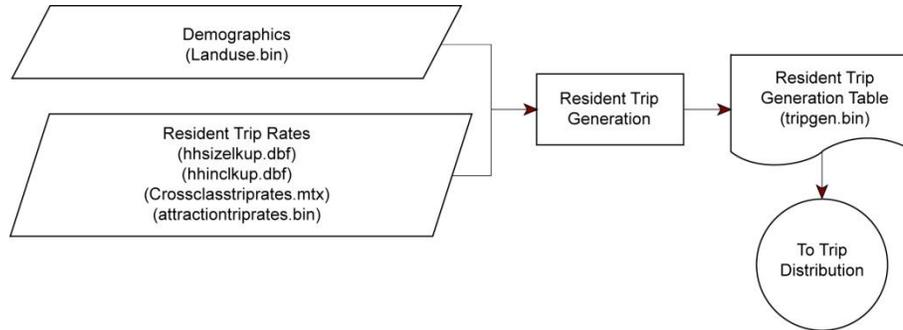

Overview

The resident trip generation models that were recently estimated and calibrated for the Clark County area were used as the starting point for the trip generation and calibration. The trip production models are cross-classification models stratified by income group and household size. In effect, the models provide trip production rates by trip purpose for each household size, income group stratum. The independent variable used is the number of households in the stratum. Five household size strata are used:

- 1 person households
- 2 person households
- 3 person households
- 4 person households
- 5 or more person households

The travel model uses four household income groups, consistent with the 2000 U.S. Census income categories. All incomes are represented in 1999 dollars:

- Low income (Less than \$19,999)
- Lower-middle income (\$20,000 to \$29,999)
- Upper-middle income (\$30,000 to \$49,999)
- High income (\$49,999 or more)

It is necessary to estimate a joint distribution of households by income group and household size (*i.e.*, 20 separate cells) for each TAZ. Submodels (documented below) are provided to produce these data from normal socioeconomic information forecast for each TAZ: population in households, number of households, and median income. As income increases, the rate of auto ownership and trip generation increases.

The trip attraction models are cross-classification-like models with number of employees by employment by type and households being the explanatory variables. The employment and household data are normally forecast by TAZ.

Douglas County/Carson City Regional Travel Demand Model

The resident trip generation models have been developed for the following trip purposes:

- Home-Based Work (HBWork)
- Home-Based School (HBSchool)
- Home-Based Shop (HBSHOP)
- Home-Based Other (HBOther)
- Non-Home-Based (NHB)

All trip rates documented herein are based on total person trips made in motorized vehicles. Person trips made using non-motorized modes such as walk, wheelchair, or bicycle and person trips made using unspecified modes were not included in the data used to estimate the trip rates.

Socioeconomic Submodels

Socioeconomic submodels were developed from 2000 Census data to estimate the number of households by income group and household size for each TAZ. Three submodels were developed:

- A submodel to estimate the number of households by household size based on the average household size of the TAZ and the number of households in the TAZ.
- A submodel to estimate the number of households by income group based on the ratio of the median income for the TAZ to the regional median income and the number of households in the TAZ.
- A submodel to estimate the joint distribution of households by income group and household size based on the results from the above two submodels.

Year 2000 Census Data

Data for Douglas County and Carson City were estimated based on Year 2000 Census information. Table 4-1 shows the summary of the household information. The information for persons per household and number of households in certain income ranges was extracted from the dataset, which contained 64 block groups. The block group data have been used to estimate household size and income group submodels for use in the trip generation modeling process. The regional median income is based on the 2000 U.S. Census information for both Douglas County and Carson City. This data reveals that one-half of the households have an income less than \$44,448 and the other half of the households have an income above this figure. The household population includes everybody living in the household regardless of their age. Table 4-1 has been revised to clarify the total households in both subsets.

The Households Size Disaggregation and Household Income Disaggregation Submodels were borrowed from the 2004 Las Vegas RTC Travel Demand Model recently developed by Parsons for the Las Vegas metropolitan area. This model also used data from the existing Carson City model. The joint distributions of households by household size and household income was, however, calibrated to the 2000 Census information for the counties of Douglas and Carson City. Table 4-2 presents the 2014 data for Douglas County and Carson City.

Douglas County/Carson City Regional Travel Demand Model

Table 4-1: Douglas County and Carson City—2000 Census Data Summary

CATEGORY	UNITS
Population	93,716
1 person households	9,010
2 person households	14,055
3 person households	5,700
4 person households	4,746
5+ person households	<u>3,154</u>
Total occupied households	36,665
Households with income less than \$19,999	6,472
Households with income between \$20,000 and \$29,999	4,374
Households with income between \$30,000 and \$49,999	8,893
Households with income greater than \$49,999	<u>16,926</u>
Total occupied households	36,665

Table 4-2: Douglas County and Carson City—2014 Data Summary

CATEGORY	UNITS
Population	102,079
1 person households	10,082
2 person households	15,697
3 person households	6,353
4 person households	5,328
5+ person households	<u>8,525</u>
Total occupied households	40,984
Households with income less than \$19,999	7,213
Households with income between \$20,000 and \$29,999	4,877
Households with income between \$30,000 and \$49,999	10,000
Households with income greater than \$49,999	<u>18,894</u>
Total occupied households	40,984

Households by Household Size Disaggregation Submodel

The hypothesis underlying the household size disaggregation model is that for any given zonal average household size (*i.e.*, persons per household) there is a specific “mix” of households for each integer household size (*i.e.*, one person households, two person households, etc.). In order to implement this hypothesis as a functional model, household data from the 2000 Census were summarized and grouped by average household size. This summarization was performed at the census block group level with data grouped by ranges of 0.1 persons per dwelling unit (for example, 1.0 to 1.04 were grouped to the 1.0 range, 1.05 to 1.14 were grouped to 1.1, 1.15 to 1.24

Douglas County/Carson City Regional Travel Demand Model

were grouped to 1.2, etc.). The summarized data showed a reasonable relationship between average household size and the distribution of the integer persons per household when they were plotted.

A preliminary model was developed by “hand-fitting” curves to the census data. These non-linear, hand-fitted curves were not an adequate model since the percent of integer households did not necessarily meet two essential criteria. These two criteria were:

- The sum of the integer household percents equal 100.0 for each average household size
- The average persons per household calculated from the integer household percents equal the average household size being used as the independent variable.

Each average household size range was investigated to ascertain the change required in the integer household size percents to meet the above two criteria. The curves were then redrawn and smoothed to produce a usable household size disaggregation model. The final model is shown in Figure 4-1 and Table 4-3.

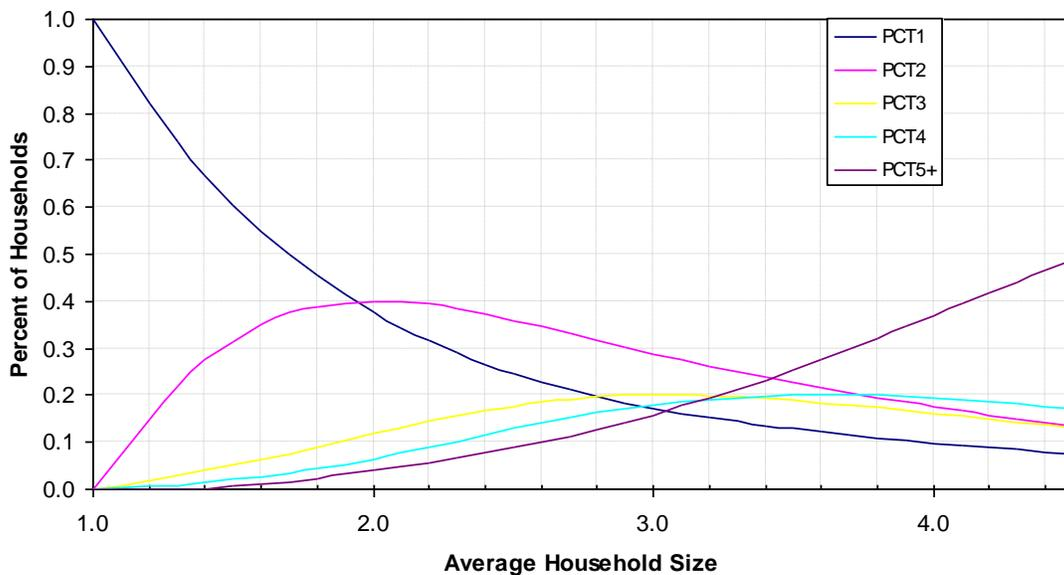

Figure 4-1: Household Size Disaggregation Submodel

Douglas County/Carson City Regional Travel Demand Model

Table 4-3: Household Size Disaggregation Submodel

INPUT AVERAGE HOUSEHOLD SIZE	PROPORTION OF HOUSEHOLDS BY SIZE						IMPLIED AVERAGE HOUSEHOLD SIZE ¹
	1 PERSON	2 PERSON	3 PERSON	4 PERSON	5+ PERSON	SUM	
1.0	1.000	0.000	0.000	0.000	0.000	1.000	1.000
1.1	0.906	0.082	0.001	0.002	0.008	1.000	1.128
1.2	0.820	0.159	0.003	0.004	0.014	1.000	1.241
1.3	0.742	0.222	0.006	0.013	0.016	1.000	1.349
1.4	0.672	0.274	0.022	0.016	0.016	1.000	1.441
1.5	0.608	0.315	0.038	0.018	0.021	1.000	1.541
1.6	0.551	0.347	0.055	0.019	0.030	1.000	1.648
1.7	0.499	0.370	0.070	0.025	0.035	1.000	1.749
1.8	0.453	0.386	0.086	0.036	0.040	1.000	1.847
1.9	0.412	0.395	0.100	0.047	0.045	1.000	1.946
2.0	0.375	0.399	0.114	0.059	0.052	1.000	2.045
2.1	0.343	0.398	0.127	0.072	0.060	1.000	2.144
2.2	0.314	0.393	0.139	0.085	0.069	1.000	2.244
2.3	0.288	0.385	0.150	0.098	0.079	1.000	2.343
2.4	0.265	0.375	0.159	0.110	0.091	1.000	2.441
2.5	0.245	0.362	0.167	0.123	0.103	1.000	2.539
2.6	0.227	0.348	0.174	0.135	0.116	1.000	2.635
2.7	0.211	0.333	0.179	0.146	0.130	1.000	2.730
2.8	0.197	0.318	0.183	0.157	0.146	1.000	2.824
2.9	0.184	0.302	0.185	0.167	0.162	1.000	2.917
3.0	0.173	0.286	0.186	0.176	0.179	1.000	3.009
3.1	0.163	0.271	0.186	0.184	0.197	1.000	3.099
3.2	0.153	0.257	0.184	0.190	0.216	1.000	3.188
3.3	0.145	0.243	0.181	0.195	0.236	1.000	3.277
3.4	0.137	0.230	0.177	0.199	0.257	1.000	3.365
3.5	0.129	0.218	0.172	0.201	0.280	1.000	3.508
3.6	0.122	0.207	0.165	0.201	0.304	1.000	3.600
3.7	0.116	0.197	0.159	0.200	0.329	1.000	3.693
3.8	0.110	0.187	0.151	0.196	0.356	1.000	3.786
3.9	0.104	0.178	0.143	0.191	0.384	1.000	3.881
4.0	0.098	0.169	0.135	0.211	0.387	1.000	4.005
4.1	0.093	0.160	0.127	0.200	0.420	1.000	4.114
4.2	0.088	0.150	0.119	0.187	0.455	1.000	4.226
4.3	0.084	0.140	0.112	0.171	0.494	1.000	4.343
4.4	0.081	0.128	0.105	0.165	0.521	1.000	4.439
4.5	0.078	0.114	0.100	0.153	0.555	1.000	4.549

¹ Average household sizes for five or more person households used to estimate the implied average household size:

<u>Input Household Size Range</u>	<u>Average 5+ Household Size</u>
1.00 – 3.49	5.6
3.50 – 3.50	5.8
4.00 or more	6.0

Households by Income Group Disaggregation Model

The income group disaggregation model is similar in form to the household size disaggregation model. The independent variable for the model is the ratio of the TAZ median income to the regional median income. The model was estimated using block level data from the 2000 Census. The income ranges defined by the Census for the block group data that was used for the income group disaggregation model are shown in the Table 4-4. The regional median income in 1999 dollars and median incomes for each of the block groups were also obtained from the block group data.

Table 4-4: Household Income Classification

INCOME GROUP	2000 CENSUS INCOME RANGE USED (1999 DOLLARS)	HOUSEHOLDS IN RANGE (2000 CENSUS)	
		NUMBER	PERCENT
Low	Less than \$19,999	6,472	17.6%
Lower-middle	\$20,000–\$29,999	4,374	11.9%
Upper-middle	\$30,000–\$49,999	8,893	24.3%
High	\$50,000 or more	16,926	46.2%

For future forecasts, median incomes can be left unchanged in stable TAZs. For TAZs that are developed or redeveloped between the base and forecast years, TAZ median incomes can be estimated from similar TAZs. Future year income forecasts can be in 1999 or future year dollars. The effect of changing the base year for income forecasts will be accounted for by using the ratio of the TAZ median income to the regional median income. In effect, the income group disaggregation model is “self-correcting” for changes in real or inflationary income.

The ratios of the TAZ median incomes to the regional median income and the proportions of households in each of the four income groups were calculated for each block group. Four curves were then developed for the income group disaggregation submodel to represent the proportions of households within the income ranges for each value of the income ratio. The proportions defining the curves were constrained to sum to 1.0 for each value of the income ratio. In addition, the curves were defined such that the implied TAZ median income would fall in the income group implied by the input income ratio. For example, if the input TAZ median income is \$31,200, the TAZ to regional median income ratio is 0.7. The income group disaggregation model, a total of 48.1 percent of the households would have incomes in the low and lower-middle income group ranges. The lowest 5.96 percent of the 31.9 percent of the households in the upper-middle income range (*i.e.*, 1.9 percent of all households in the region) would also have incomes less than \$31,200. If incomes in the upper-middle income range are assumed to be uniformly distributed (an unlikely case), the implied median income for the TAZ would be 5.96 percent of the range from \$30,000–\$49,999, or \$31,192. Table 4-5 and Figure 4-2 show the income group disaggregation model.

Douglas County/Carson City Regional Travel Demand Model

Table 4-5: Income Group Disaggregation Submodel

INPUT INCOME RATIO	PROPORTION OF HOUSEHOLDS BY INCOME GROUP				TOTAL	IMPLIED MEDIAN INCOME	IMPLIED INCOME RATIO
	LOW INCOME	LOWER-MIDDLE INCOME	UPPER-MIDDLE INCOME	HIGH INCOME			
0.10	1.000	0.000	0.000	0.000	1.000	10,000	0.22
0.20	1.000	0.000	0.000	0.000	1.000	10,000	0.22
0.30	0.725	0.155	0.090	0.030	1.000	13,792	0.31
0.40	0.550	0.230	0.162	0.058	1.000	18,181	0.41
0.50	0.430	0.247	0.225	0.098	1.000	22,834	0.51
0.60	0.349	0.230	0.280	0.141	1.000	26,572	0.60
0.70	0.281	0.200	0.319	0.200	1.000	31,168	0.70
0.80	0.230	0.173	0.336	0.261	1.000	35,774	0.80
0.90	0.192	0.150	0.339	0.319	1.000	39,321	0.88
1.00	0.165	0.132	0.319	0.384	1.000	42,727	0.96
1.10	0.140	0.116	0.287	0.457	1.000	47,003	1.05
1.20	0.119	0.104	0.260	0.517	1.000	n/a ¹	n/a ¹
1.30	0.100	0.092	0.240	0.568	1.000	n/a ¹	n/a ¹
1.40	0.085	0.082	0.220	0.613	1.000	n/a ¹	n/a ¹
1.50	0.070	0.070	0.200	0.660	1.000	n/a ¹	n/a ¹
1.60	0.060	0.060	0.181	0.699	1.000	n/a ¹	n/a ¹
1.70	0.050	0.051	0.163	0.736	1.000	n/a ¹	n/a ¹
1.80	0.045	0.043	0.146	0.766	1.000	n/a ¹	n/a ¹
1.90	0.040	0.037	0.132	0.791	1.000	n/a ¹	n/a ¹
2.00	0.036	0.031	0.116	0.817	1.000	n/a ¹	n/a ¹
2.10	0.032	0.025	0.103	0.840	1.000	n/a ¹	n/a ¹
2.20	0.027	0.020	0.088	0.865	1.000	n/a ¹	n/a ¹
2.30	0.024	0.017	0.080	0.879	1.000	n/a ¹	n/a ¹
2.40	0.021	0.013	0.070	0.896	1.000	n/a ¹	n/a ¹
2.50	0.018	0.011	0.060	0.911	1.000	n/a ¹	n/a ¹
2.60	0.016	0.009	0.050	0.925	1.000	n/a ¹	n/a ¹
2.70	0.014	0.007	0.041	0.938	1.000	n/a ¹	n/a ¹
2.80	0.012	0.005	0.033	0.950	1.000	n/a ¹	n/a ¹
2.90	0.010	0.004	0.027	0.959	1.000	n/a ¹	n/a ¹
3.00	0.008	0.003	0.021	0.968	1.000	n/a ¹	n/a ¹
3.10	0.007	0.002	0.018	0.973	1.000	n/a ¹	n/a ¹
3.20	0.007	0.002	0.013	0.979	1.000	n/a ¹	n/a ¹
3.30	0.006	0.001	0.010	0.983	1.000	n/a ¹	n/a ¹
3.40	0.006	0.001	0.007	0.987	1.000	n/a ¹	n/a ¹
3.50	0.005	0.001	0.004	0.990	1.000	n/a ¹	n/a ¹
3.60	0.005	0.000	0.002	0.994	1.000	n/a ¹	n/a ¹
3.70	0.004	0.000	0.001	0.995	1.000	n/a ¹	n/a ¹
3.80	0.004	0.000	0.001	0.996	1.000	n/a ¹	n/a ¹
3.90	0.003	0.000	0.000	0.997	1.000	n/a ¹	n/a ¹
4.00	0.003	0.000	0.000	0.998	1.000	n/a ¹	n/a ¹
4.10	0.002	0.000	0.000	0.998	1.000	n/a ¹	n/a ¹
4.20	0.002	0.000	0.000	0.999	1.000	n/a ¹	n/a ¹
4.30	0.001	0.000	0.000	0.999	1.000	n/a ¹	n/a ¹
4.40	0.000	0.000	0.000	1.000	1.000	n/a ¹	n/a ¹
4.50	0.000	0.000	0.000	1.000	1.000	n/a ¹	n/a ¹
4.60	0.000	0.000	0.000	1.000	1.000	n/a ¹	n/a ¹
4.70	0.000	0.000	0.000	1.000	1.000	n/a ¹	n/a ¹
4.80	0.000	0.000	0.000	1.000	1.000	n/a ¹	n/a ¹

¹ Since the median income falls in the high income group and the maximum income for that group is undefined, the implied median income cannot be estimated.

Douglas County/Carson City Regional Travel Demand Model

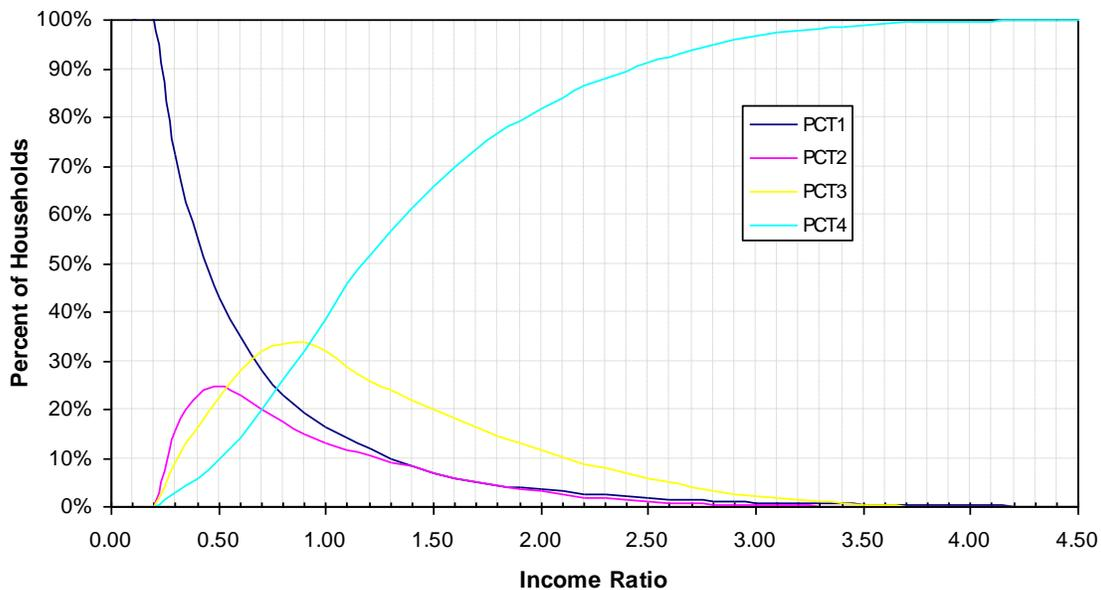

Figure 4-2: Income Group Disaggregation Submodel

Estimating Joint Distributions of Households by Socioeconomic Strata

The two submodels described in the previous sections result in *preliminary* estimates of the following “univariate,” or “marginal,” distributions of households for each TAZ:

- Households by household size
- Households by income group

The initial applications of the models result in preliminary estimates for the following reason. If the households are summed over the strata included in each univariate distribution for each TAZ, the total will be the number of households for the TAZ. For example, if the estimated households by household size are summed for TAZ 1, the total will be the number of households in TAZ 1.

To ensure that the regional sums match, a marginal weighting, or *fratar*, process can be applied on a regional basis. For this application, the input “matrices” are the estimates of households for each TAZ in the region from the preliminary applications of the household size or income group disaggregation submodels. The marginal distributions for this application of the marginal weighting process are the total numbers of households for each TAZ and the estimated regional households for the socioeconomic stratum being factored—regional households by household size or regional households by income group. The results of this marginal weighting step will ensure that the total numbers of households for each TAZ are correct when the various socioeconomic distributions are summed by TAZ, and that the regional households by socioeconomic stratum are correct when the households for the stratum are summed across all TAZs. Regional distributions of households by income group *and* household size are used to develop the regional control totals for households.

A third submodel completes the disaggregation and results in estimates of households jointly stratified by income group and household size for each TAZ. The submodel uses the results from the modified marginal distributions of households by income group and households by household size for each TAZ along with the regional joint distribution of households by income group and

Douglas County/Carson City Regional Travel Demand Model

household size (Tables 4-6 and 4-7). The final joint distributions are shown in Tables 4-5 and 4-6 and were developed by updating the joint distributions that was developed for Clark County. The Clark County joint distribution is based on the Public Use Micro Sample (PUMS) data from the 2000 Census, which is a one percent sample of all households for a given county. The Clark County estimates for the joint distribution was then frateded to match the marginals that were obtained for the 2000 Census for Douglas County and Carson City by household size and income group. The median income for each TAZ was derived from the 2000 Census block group data and is represented in 1999 dollars.

Table 4-6: Households by Income Group and Household Size

INCOME GROUP	HOUSEHOLD SIZE					TOTAL
	1	2	3	4	5+	
Low	3,689	1,481	640	391	270	6,472
Low-middle	1,483	1,756	523	389	224	4,374
Upper-middle	2,269	2,654	1,393	986	681	8,893
High	1,569	7,163	3,234	2,981	1,979	16,926
Total	9,010	14,055	5,700	4,746	3,154	36,665

Table 4-7: Proportion of Households by Income Group and Household Size

INCOME GROUP	HOUSEHOLD SIZE					TOTAL
	1	2	3	4	5+	
Low	10.1%	4.0%	1.7%	1.1%	0.7%	17.7%
Low-middle	4.0%	4.8%	1.4%	1.1%	0.6%	11.9%
Upper-middle	6.2%	10.0%	3.6%	2.7%	1.9%	24.3%
High	4.3%	19.5%	8.8%	8.1%	5.4%	46.2%
Total	24.6%	38.3%	15.5%	12.9%	8.6%	100.0%

The third submodel effectively fratars the regional joint distribution of households by income group and household size on a TAZ-by-TAZ basis to match the modified marginal distributions of households by income group and households by household size for each TAZ. All three submodels have been coded in TransCAD GISDK scripts for automatic application each time the trip generation module is invoked.

Socioeconomic Model Application Summary

In summary, the process for estimating the number of households for the joint distribution of households by income group and household size for each TAZ makes extensive use of the marginal weighting technique. The process is as follows:

- Preliminary estimates of the number of households by income group and households by household size are developed for each TAZ using the appropriate socioeconomic disaggregation submodel.

Douglas County/Carson City Regional Travel Demand Model

- The preliminary estimates of households for each marginal socioeconomic distribution for each TAZ are marginally weighted so that the numbers of households for each TAZ and the total numbers of households for each socioeconomic group for the region are matched.
- The regional distribution of households by income group and household size are marginally weighted to match the estimated marginal distributions of households by income group and household size on a TAZ-by-TAZ basis.

All three submodels have been coded in TransCAD GISDK scripts for automatic application each time the trip generation module is invoked.

Trip Production Models

Trip production models were borrowed from the Las Vegas region and were estimated using a traditional cross-classification analysis. Purpose specific person trips made in motorized vehicles were summarized for each household and average trip rates per household were then calculated for all households within defined socioeconomic strata. As outlined in the socioeconomic data section above, two household characteristics, household size and income group, were used to define the household strata. As income becomes greater, the rate of auto ownership and trip generation generally increases. However, larger household size causes a greater increase in trip generation rates than rising income levels. These submodels were further refined to better represent Douglas and Carson City.

Home-Based Work Trip Production Model

Table 4-8 shows the Home-Based Work trip production model for the region. Based on strict statistical comparisons of trip rates, some combining of cells could have been performed. However, the increase in trip rates as household size increased and as income group increased was very reasonable.

Table 4-8: Home-Based Work Trip Production Model

INCOME GROUP	HOUSEHOLD SIZE				
	1	2	3	4	5+
Low	0.34	0.71	0.76	1.67	2.00
Lower-middle	0.65	1.07	1.46	1.79	2.27
Upper-middle	0.88	1.37	1.96	2.13	2.40
High	0.95	1.89	2.26	2.39	2.64

Home-Based School Trip Production Model

Table 4-9 shows the HBSchool trip production model for the region. Shading of cells shows the trip rate combinations performed as part of the model estimation. The HBSchool trip production model shown in Table 4-9 is for trips made in motorized vehicles to all:

- Pre-schools and kindergartens
- Elementary schools, middle schools, and high schools
- Community colleges and vocational/technical schools.

Table 4-9: Home-Based School Trip Production Model

INCOME GROUP	HOUSEHOLD SIZE				
	1	2	3	4	5+
Low	0.01	0.27	0.48	0.95	3.11
Lower-middle	0.01	0.02	0.48	0.95	3.11
Upper-middle	0.01	0.02	0.48	1.77	3.11
High	0.01	0.14	0.48	1.77	3.11

The trip rates shown in Table 4-9 tend to vary more by household size than by income group. This is logical since HBSchool trips are primarily dependent on the presence of school-age children in a household, which should be highly correlated with household size. The very low rate for one-person households reflects a small number of single person households where the householder is a student. The difference between trip rates for low and lower-middle income, two person households probably reflects the impact of single-parent households. Specifically, low income, two-person households are probably more likely to be “single parent with a child” households, while two (working) adults are more likely to comprise two-person, lower-middle and upper-middle income households.

The HBSchool trip production model shown in Table 4-9 has sensitivity to household structure. In other words, since the model is stratified by household size, it is sensitive to changes in household size—the increase or decrease in number of children in a household. Nevertheless, the total HBSchool productions should be compared to the total attractions based on enrollment projections. If a large imbalance is noted, an inconsistency between forecast population and households, and forecast school enrollment is possible.

Since only person trips made in motorized vehicles have been summarized in the trip rates shown in Table 4-9, behavior regarding the propensity to walk or bicycle to school is assumed to remain constant over time. This assumption is consistent with the assumption made when HBSchool trip attractions are forecast based on school enrollment.

Home-Based Shop Trip Production Model

Table 4-10 shows the HBShop trip production model for the region. Shading of cells shows the trip rate combinations performed as part of the model estimation. Again, the trip rates tend to vary by household size, but not income group, and for this purpose, the variation in trip rates across two-, three-, and four-person households was not significant. The lack of variation across income groups is generally logical. Households need to shop for basic necessities regardless of income. Income is a primary determinant of whether shopping takes place at a high-end retail store or a discount store.

Table 4-10: Home-Based Shop Trip Production Model

INCOME GROUP	HOUSEHOLD SIZE				
	1	2	3	4	5+
Low	0.36	0.92	0.92	0.92	1.59
Lower-middle	0.54	0.92	0.92	0.92	1.59
Upper-middle	0.54	0.92	0.92	0.92	1.59
High	0.54	0.92	0.92	0.92	1.59

Douglas County/Carson City Regional Travel Demand Model

The lack of variation across household size is also reasonable. The two-person household rate is about twice the one-person household trip rate, reflecting an increased tendency for both household members to shop together. However, for three- and four-person households, no significant increase in the trip rate was observed. This reflects the fact that, quite often, not all household members are required for the “shopping trip.” In a three- or four-person household, this would indicate the tendency for only one extra household member to participate in the shopping trip.

Home-Based Other Trip Production Model

Table 4-11 shows the HBOther trip production model for the region. Shading of cells shows the trip rate combinations performed as part of the model estimation. The variation in trip rates across household sizes is reasonable. In addition, some variation in trip rates across income groups might reflect the influence of additional disposable income, allowing for additional trips to be made (see also the NHB trip rates).

Table 4-11: Home-Based Other Trip Production Model

INCOME GROUP	HOUSEHOLD SIZE				
	1	2	3	4	5+
Low	1.46	2.68	3.63	5.83	6.54
Lower-middle	1.46	2.68	3.63	5.83	6.54
Upper-middle	1.46	2.68	3.63	5.83	6.54
High	1.46	2.68	4.76	5.83	10.44

Non-Home-Based Trip Production Model

Table 4-12 shows the NHB trip production model for the region. Shading of cells shows the trip rate combinations performed as part of the model estimation. The variation in trip rates across household sizes is reasonable. In addition, the variation in trip rates across income groups probably reflects the influence of additional disposable income allowing for additional trips to be made (see also the HBOther trip rates).

The NHB trip production model is applied only to obtain a regional control total for NHB trips. The locations of the actual trip productions are determined using an allocation model. For the Douglas County and Carson City region, the NHB trip attraction model is used as the allocation model (in effect, NHB productions are set equal to NHB attractions on a TAZ-by-TAZ basis after the NHB attractions are scaled to match the regional total NHB productions).

Table 4-12: Non-Home-Based Trip Production Model

INCOME GROUP	HOUSEHOLD SIZE				
	1	2	3	4	5+
Low	0.85	1.43	2.36	2.96	2.96
Lower-middle	1.70	1.43	2.36	2.96	2.96
Upper-middle	1.70	2.51	2.36	4.93	4.93
High	2.39	2.51	3.25	4.93	4.93

Trip Attraction Models

The trip attraction models were borrowed from the Las Vegas region and were estimated using an “aggregate” cross-classification analysis coupled with some guiding principles. The aggregate cross-classification technique was implemented by aggregating expanded trip attractions by the type of land use at the attraction end of the trip. Thus, if a person traveled from home to a store to shop and then traveled back home again, two HBShop attractions were shown at a retail land use.

Once total attractions by land use have been aggregated by land use, they are divided by the total employment (or households in the case of residential land uses) associated with the land use. Table 4-13 shows the land use types along with the associated type of employment or households used as the independent variable. While it is not possible to estimate any calibration statistics using this procedure, it has proved very successful in producing reasonable trip attraction models in other regions. It is not affected by the high correlation between the explanatory variables (e.g., employment by type) that typically plagues trip attraction models estimated using district-based linear regression techniques.

Table 4-13: Land Use Types and Explanatory Variables for Trip Attraction Rates

LAND USE TYPE	EXPLANATORY VARIABLE
Residential	Households
Basic industries including forestry, fishing, mining, manufacturing, public utilities, warehousing	Industrial employment
Retail	Retail employment
Recreational and personal services including theaters, schools, government, convention centers, daycare, sports facilities and gyms Churches and other religious facilities Medical facilities Banks Personal and business services including financial, insurance, and real estate, consultants, attorneys, accountants	Office and other non-classified employment
Casinos and hotels	Casino and hotel employment
Unknown Parks and open spaces	None

One guiding principle used in the estimation of trip attraction rates was that the explanatory variables had to be logical attractors of trips for the purpose being modeled. Thus, all home-based school trip attractions were assumed to occur at schools with the explanatory variable being school enrollment. Likewise, all home-based shop trip attractions were assumed to be made to retail establishments with retail employment being the explanatory variable.

Table 4-14 summarizes the trip attraction models. All rates shown in Table 4-14 are for person trips made in motorized vehicles. The following sections provide brief discussions of the trip attraction models.

Table 4-14: Trip Attraction Models

TRIP PURPOSE	TRIP ATTRACTION RATE PER HOUSEHOLD	REGULAR TRIP ATTRACTION RATE PER								TOTAL EMPLOYMENT-NON-HOTEL	
		EMPLOYMENT					SCHOOL ENROLLMENT				
		INDUSTRIAL	OFFICE AND NON-CLASSIFIED	RETAIL	CASINO-HOTEL	TOTAL	GRADES 1-8	GRADES 9-12	GRADES 13+		
HBWork	0.02				0.40	0.99					0.99
HBSchool							0.99	1.88	0.46		
HBSShop				2.37							
HBOther	0.38	0.60	2.46	2.07	0.48						1.97
Non-HB	0.20	1.08	1.08	3.36	0.24						0.51

Home-Based Work Trip Attraction Model

There are two items of note in the HBWork trip attraction model. First, there is a low HBWork trip attraction rate per household. While it might have been possible to specify that HBWork trips would be attracted only to establishments with employment, the low attraction rate per household is similar to that found in a number of other cities. The rate probably accounts for domestic help and service calls (e.g., insurance agents, plumbers, and large appliance repair personnel) made directly from the employee’s home to a residential worksite.

The HBWork trip productions will be output by income group in an effort to improve trip distribution modeling, and when a mode choice model is added to the modeling process, mode choice. Since the HBWork trip attraction model has not been stratified by income group, the total HBWork attractions will be scaled to match total productions for each of the four income groups in question. Such a procedure results in a trip attraction model that “assumes” that the same proportions of trip attractions by income group hold constant across all TAZs in the region. While such an assumption produces a gross regional average, the procedure and results are still quite effective in improving trip distribution and mode choice.

Home-Based School Trip Attraction Model

The HBSchool trip attraction rates vary by age of the student making the trip. The rate for elementary school-aged students (grades 1–8) is substantially lower than the rate for high school students. These rates probably reflect a higher likelihood for elementary school students to attend neighborhood schools within walking distance of the home and a higher likelihood for high school students to live farther from their schools as well as high school students’ capabilities of driving themselves to school.

The low HBSchool trip attraction rate per enrollee in grades 13 and higher probably reflects the “part-time” nature of those trips. Specifically, many students in post-high school educational institutions either attend part-time or establish their schedules so that they do not attend classes every school day.

Douglas County/Carson City Regional Travel Demand Model

Home-Based Shop Trip Attraction Model

The HBSshop trip attraction model was based on the assumption that all shop trips are attracted by retail employees. Based on the summary of the household survey data, numerous shop trips were made to non-retail land uses. Undoubtedly, this happened in some cases—a trip for shopping purposes might have been made to a retail establishment at a casino (listing the casino as the destination), a person could have stopped at a beauty salon to purchase hair care products, or a could have stopped at someone’s home to pick up goods from an in-home business. In some cases (e.g., the shopping trips to the beauty salon or the home), shopping trips are truly made to land uses with no retail employees. However, these unadjusted HBSshop rates for non-retail were very small (0.01 trips per employee). Thus, the assumption that all HBSshop trips are attracted by retail employment is reasonable.

The HBSshop rate per full-time equivalent retail employee might seem low—2.37 HBSshop trip attractions per retail employee suggests that each retail employee serves only about 1.15 people per day. However, if HBSshop, HBOther, and NHB trips per retail employee are summed, the overall attraction rate per retail employee is 11.16 (NHB must be counted twice due to the method used to model NHB trips), or about 5.6 people per day.

Home-Based Other Trip Attraction Model

The HBOther trip attraction model includes rates for all types of employment and for households. The travel demand model attracts 0.38 HBOther person trips per household. In essence, this suggests that, on the average, about one out of every five homes has a visitor during the day. Thus, the travel demand model focuses HBOther attractions more toward employment areas than toward residential areas.

Non-Home-Based Trip Attraction Model

Like the HBOther trip attraction model, the NHB trip attraction model includes rates for all types of employment and for households. Continuing the example of trips attracted per household, the travel demand model attracts 0.2 NHB trips per day. Since NHB productions are set equal to NHB attractions on a TAZ-by-TAZ basis after balancing to the regional control total for NHB trips estimated using the household-based trip production model, each home attracts an average of 0.2 visitors per day. Combined with the HBOther rates, the travel demand model suggests that each home has 0.4 visitors per day, or in other words, every 2.5 homes has a visitor each day.

Special Generator Trip Attraction Models

The trip attraction model includes unique trip attraction rates for casinos and is considered as “special generator” with the ability to have unique trip attraction rates per employee. The special generator models simply affect the total trip attractions to these locations. It must be noted however that the special generators are not currently being used but are provided as part of the model development and can be used without any changes to the model structure.

5. TRIP DISTRIBUTION

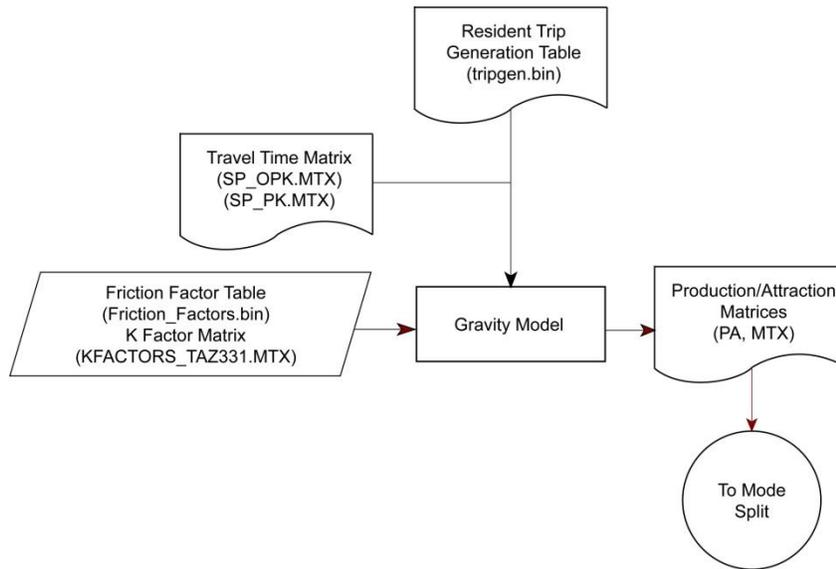

Introduction

Trip distribution assigns the trips calculated during trip generation to the appropriate production and attraction TAZ pairs. The trips to each TAZ pair are determined based on the gravity model.

$$T_{ij} = P_i \times \left[\frac{K_{ij} \times F_{ij} \times A_j}{\sum_{k=1}^n (K_{ik} \times F_{ik} \times A_k)} \right]$$

where:

- T_{ij} = trips between zone i and zone j
- P_i = productions in zone i
- A_j = attractions in zone j
- K_{ij} = K-factor adjustment between zone i and zone j
- F_{ij} = friction factor between zone i and zone j
- i = production zone
- j = attraction zone
- n = total number of zones

The calibration process calculates the friction factors and K-factors used in the above equation. The goal in calibrating trip distribution is to arrive at friction factors and K-factors such that the average trip lengths and trip length frequency distributions resulting for each trip purpose are similar to those from survey data.

Gamma Function

The friction factors used in the Douglas County/Carson City Travel Demand Model are based on a gamma function. This type of function has three parameters—alpha (a), beta (b), and gamma (c)—as shown in the following equation.

$$F_{ij} = a \times t_{ij}^b \times e^{ct_{ij}}$$

where:

F_{ij} = friction factor between zone i and zone j

t_{ij} = travel time between zone i and zone j

a = alpha parameter

b = beta parameter

c = gamma parameter

This document adheres to the above equation in defining the three parameters. TransCAD, however, requires the values of beta and gamma to be of the opposite sign when defining the parameters. The values input into the TransCAD model script for beta and gamma are opposite the values listed in this document.

The gamma function is a smooth, monotonically decreasing function when both the beta and gamma parameters are negative. This suggests that travelers are sensitive to travel time as they travel to satisfy their needs. For example, a person is less likely to travel to a grocery store ten minutes from home if there is a store only five minutes from home.

If the calibrated beta parameter is positive, the function increases to an inflection point and then decreases as the travel time increases. In general, this should be avoided, since it implies that up to a certain point, travelers have a desire to travel further to satisfy their need for travel. In certain cases, a positive beta parameter can be justified.

If the calibrated gamma parameter is positive, the function decreases to a point and then increases. A positive gamma parameter can be used if the inflection point is greater than the highest travel time expected between any two points in the region. Alternatively, the function can be converted to a look-up table and modified to be equal to the minimum value at travel times greater than the inflection point.

Source of Data

The work trip length frequency distribution from the 2000 Census was obtained for Douglas County and Carson City. This observed data was used to compare the modeled trip length frequencies.

Calibration Process

The trip distribution calibration process included determining the parameters for the friction factors and calculating the K-factors. K-factors are calculated to adjust for major distribution characteristics not explained by travel time. These differences may be caused by natural or manmade barriers, such as rivers or railroads, or by socioeconomic characteristics. The first

Douglas County/Carson City Regional Travel Demand Model

process was to determine the friction factor parameters. After the friction factors were finalized, it was found that there was no need to calculate K-factors. The K-factors procedures are provided as part of the model development process but were not used

Friction Factor Parameters

The following list explains the general process taken for each trip purpose to calculate the friction factors.

- Run the model with reasonable set of friction factor parameters obtained from another region.
- Compare histograms and average trip lengths of the results of the model run with the observed data.
- Based on the results of the comparisons, calculate the desired friction factors for a new model run that would more closely match the observed trip length frequency distribution.
- Use linear regression techniques (based on a log-transformation of the gamma function) to convert the desired friction factors into revised gamma function parameters for use in TransCAD.
- Run the model with the new gamma function parameters and continue with the comparisons and calculations of new gamma parameters until the results compare reasonably with the observed data.

Calibrated gamma function parameters for home-based work trips are shown in Table 5-1 and Figure 5-1 shows the gamma functions.

Table 5-1: Final Friction Factor Parameters—Home-Based Work

PARAMETER	HBW-INCOME 1	HBW-INCOME 2	HBW-INCOME 3	HBW-INCOME 4
Alpha	1,064,931	1,064,931	1,064,931	1,064,931
Beta	-0.452	-0.452	-0.452	-0.452
Gamma	-0.063	-0.063	-0.063	-0.063
Format	Function	Function	Function	Function

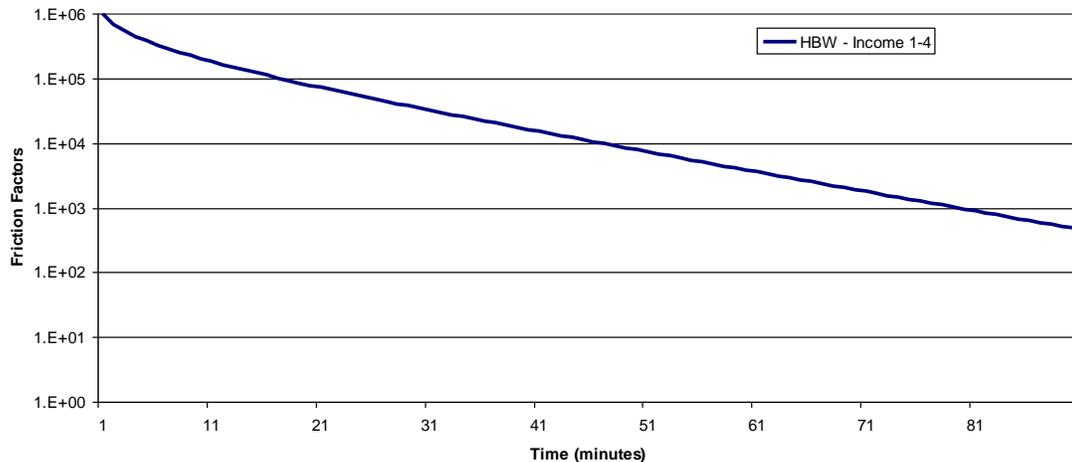

Figure 5-1: Friction Factor Parameters—Home-Based Work

Douglas County/Carson City Regional Travel Demand Model

Table 5-2 and Figure 5-2 show the friction factors for other resident trip purposes. The gamma parameter is positive for the home-based shop and home-based other trip purposes. The home-based shop gamma function begins increasing after about 80 minutes of travel time and the home-based other function begins increasing after about 60 minutes of travel time. For the non-home-based and home-based other trip purposes, the gamma function was converted to a tabular form for use in TransCAD. The friction factors for travel times greater than the times at the inflection points were modified to be equal to the minimum value of the gamma function.

Table 5-2: Final Friction Factor Parameters—Other Trip Purposes

PARAMETER	HBSCHOOL	HBSHOP	HBOTHER	NHB
Alpha	1,136,464	1,185,375	1,072,144	967,402
Beta	-1.972	-1.639	-1.646	-2.824
Gamma	-0.128	-0.170	-0.070	0.033
Format	Function	Function	Table	Table

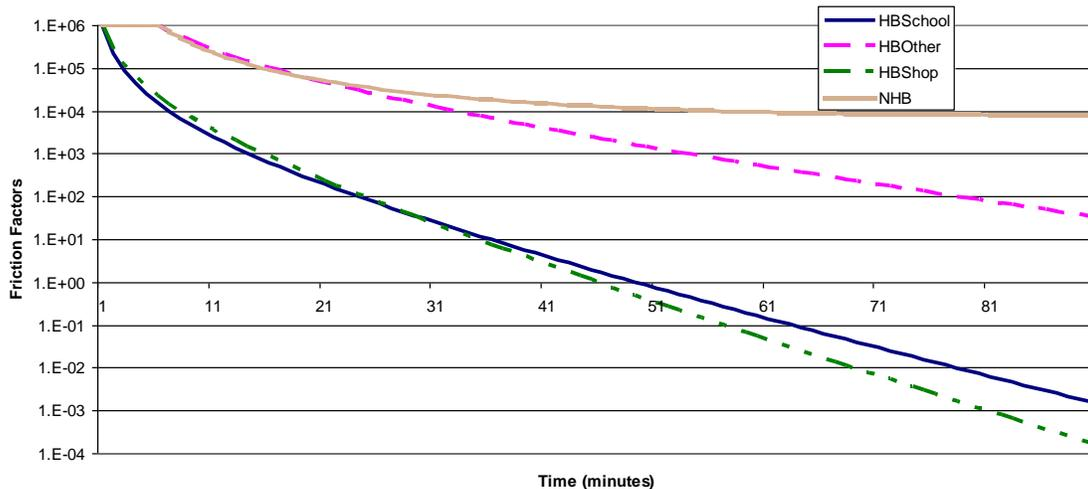

Figure 5-2: Friction Factor Parameters—Other Trip Purposes

Travel Time Comparison

The travel times information for HBW Journey to Work data was not available for 2010. More comprehensive information was available for the 2000 Census that was recently updated. The HBW trip travel times were compared to this data. The trip travel times in the model are slightly lower, as this does not reflect travel from Douglas County and Carson County to the external counties. The external networks are restricted to the gateway locations, and hence, the true length is not accurately represented for external travel.

It can also be seen that 90 percent of the work trips are within 44 minutes of commute time and the modeled trips reflect about 98 percent of the trips within the same time period. The travel time comparison of Home based work trips with the recently updated 2000 Census information is shown in Figure 5-3.

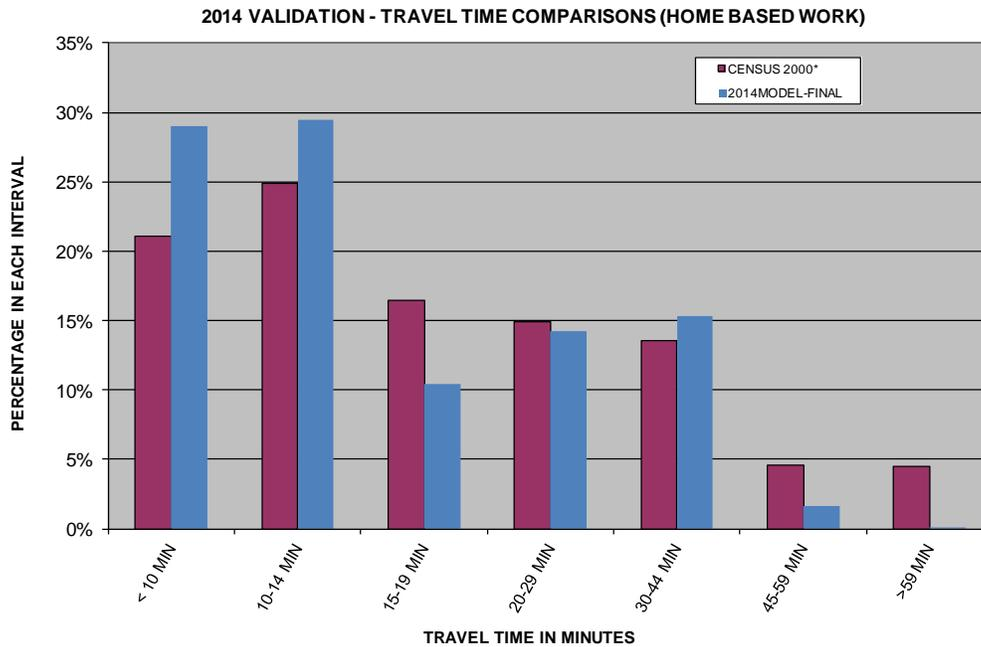

Figure 5-3. Home-based Work Travel Time Comparison

Travel Time and Trip Length Frequency Distributions

The travel time for Home based work trips is shown in Figure 5-4. The trip length frequency distributions are based on trip duration (time) using 5 minute “bins” to categorize the data. Table 5-3 summarizes the travel time results for all the Home-based work trip purposes.

The trip length (distance) for Home Based work trip purposes is shown in Figure 5-5 and uses 0.25 mile bins to categorize the data.

In other words, the bin for 5 minutes represents all trips in the range 5.0 to 9.99 minutes; the bin for 0.25 mile includes all trips in the range 0.0 to 0.25 miles.

Although no information was available for other trip purposes from the census, the travel times and trip distances for these other trip purposes are within acceptable limits. Figures 5-6 to 5-9 and the Table 5-4 summarizes the results for the non work trip purposes.

Douglas County/Carson City Regional Travel Demand Model

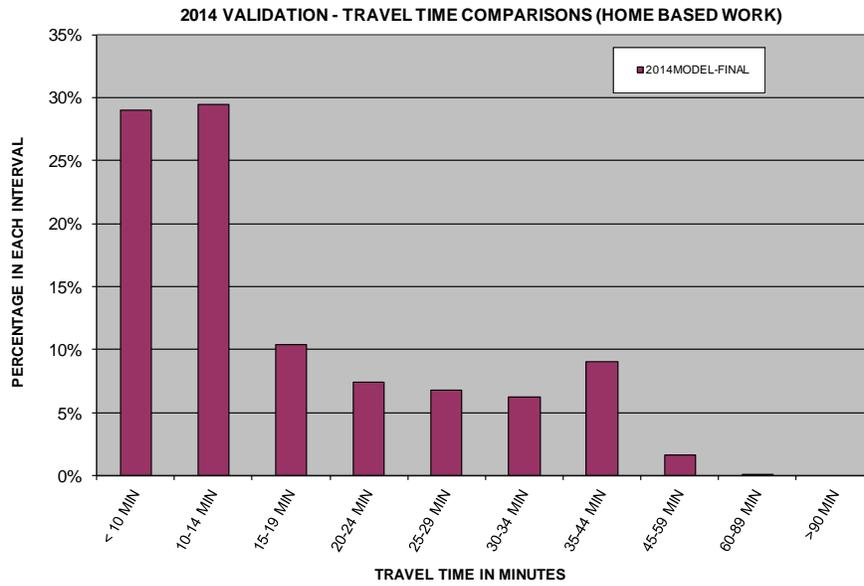

Figure 5-4: Travel Time Frequency Distributions—Home-Based Work Trips

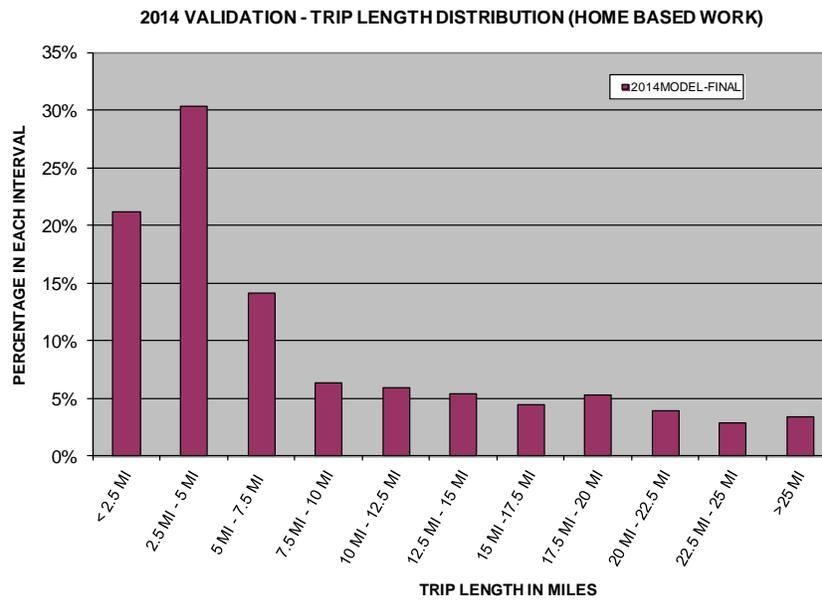

Figure 5-5: Trip Length Frequency Distributions—Home-Based Work Trips

Douglas County/Carson City Regional Travel Demand Model

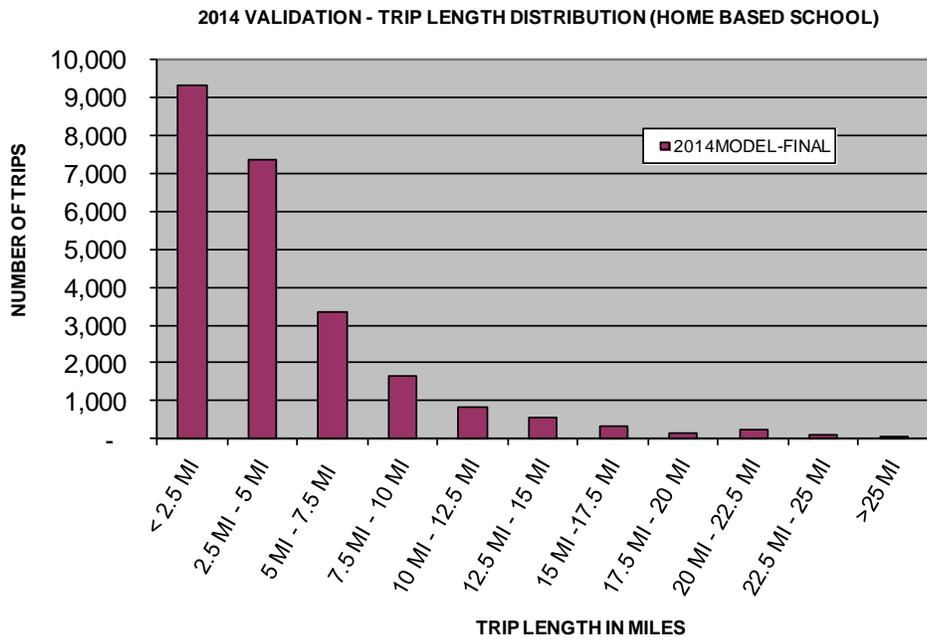
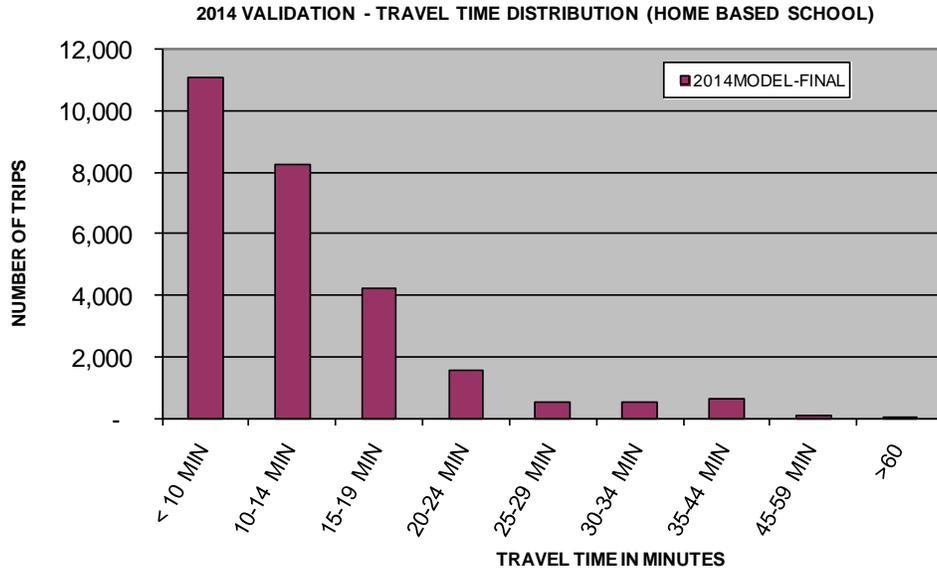

Figure 5-6: Home-Based School Trips – Frequency Distribution

Douglas County/Carson City Regional Travel Demand Model

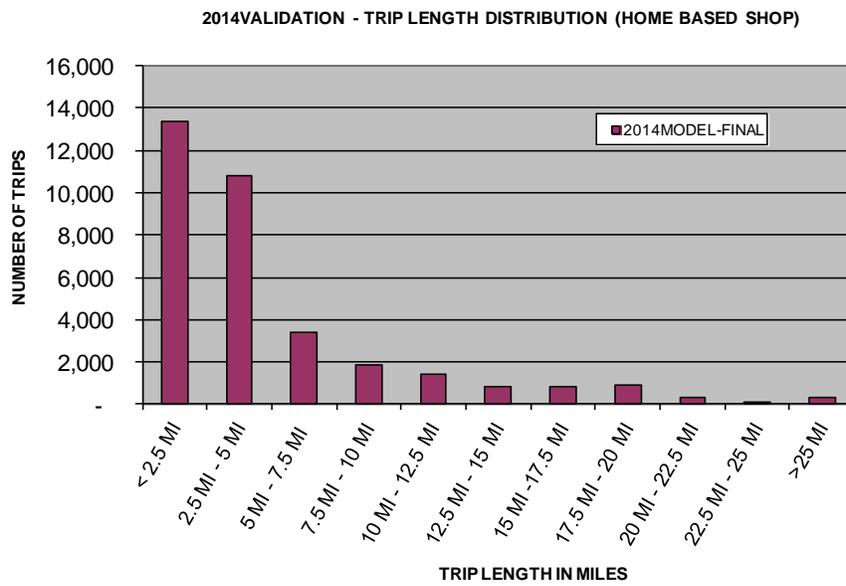
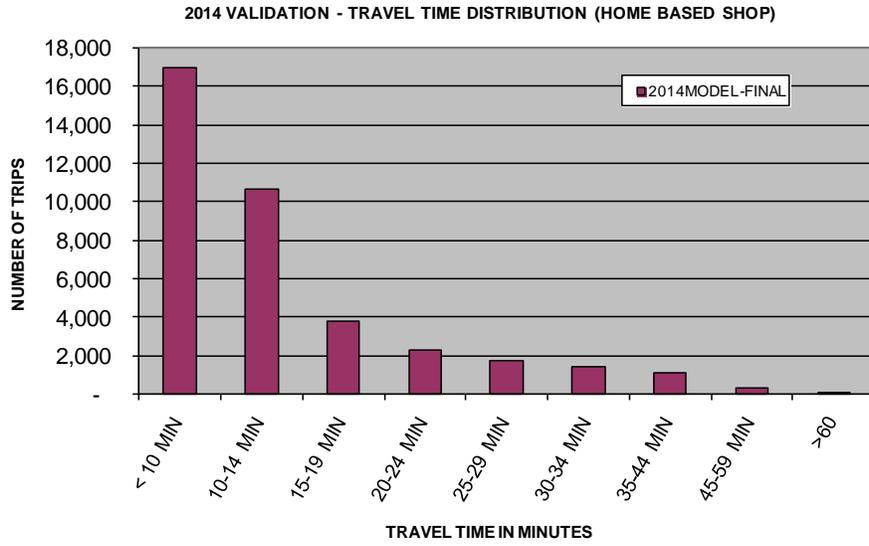

Figure 5-7: Home-Based Shop Trips – Frequency Distribution

Douglas County/Carson City Regional Travel Demand Model

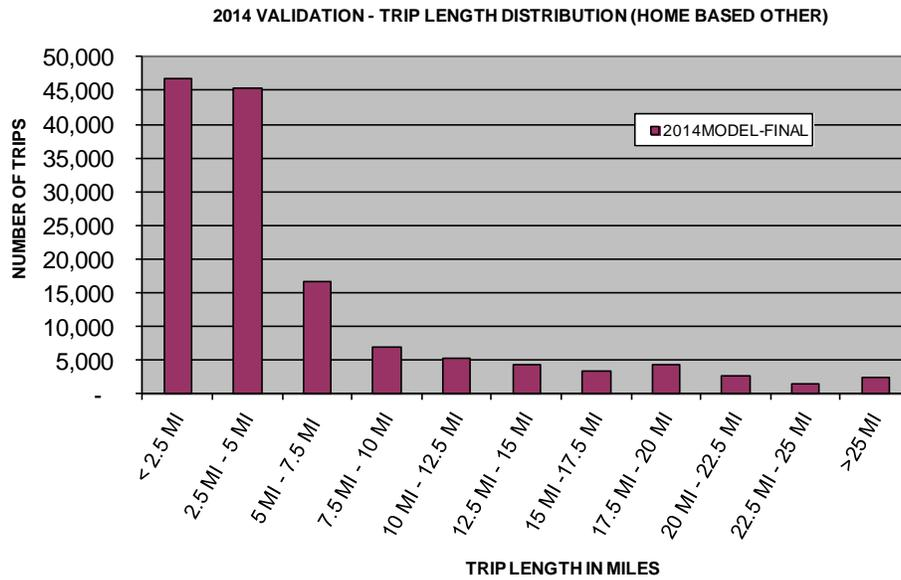
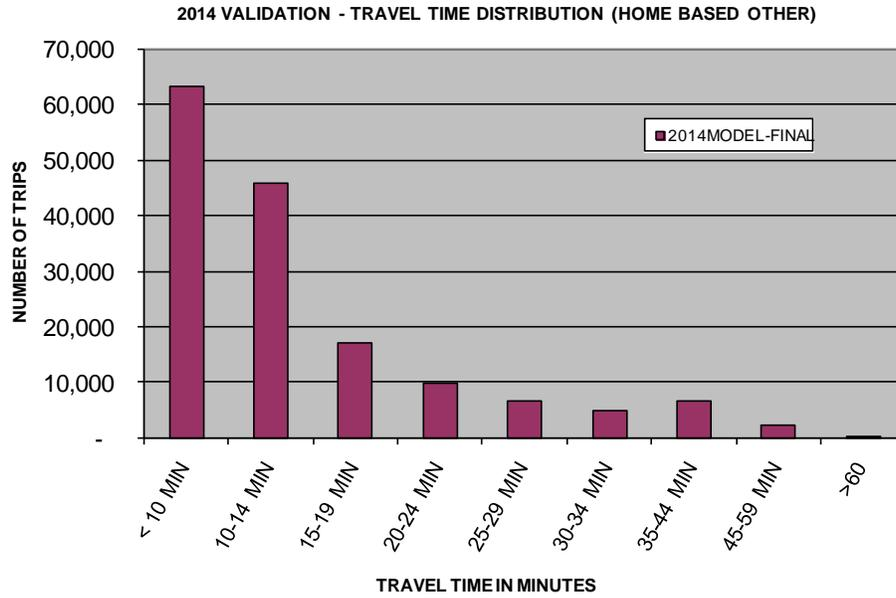

Figure 5-8: Home-Based Other Trips – Frequency Distribution

Douglas County/Carson City Regional Travel Demand Model

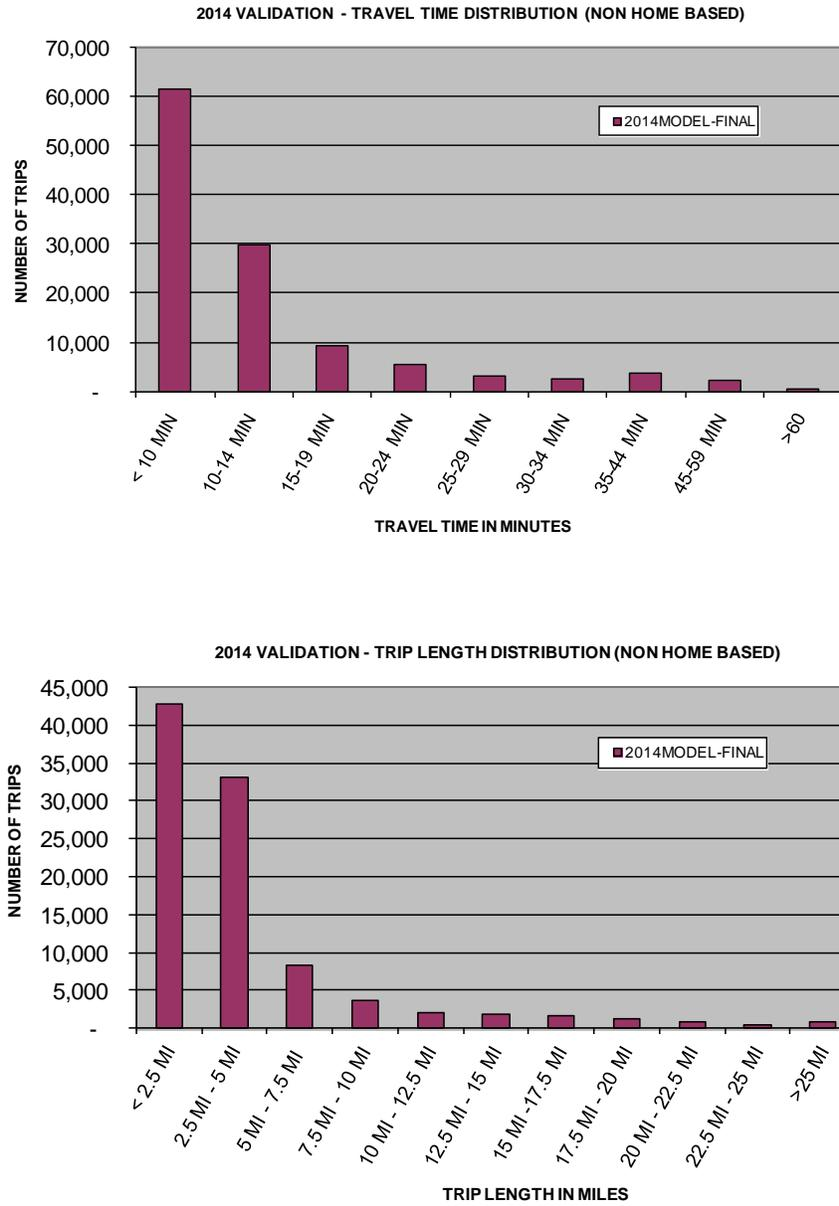

Figure 5-9: Non-Home Based Trips – Frequency Distribution

Douglas County/Carson City Regional Travel Demand Model

Table 5-3: Trip Distribution Calibration Results—Home-Based Work Trips by Income Group

	HBW – INCOME 1	HBW – INCOME 2	HBW – INCOME 3	HBW – INCOME 4	HBW - TOTAL
Observed					
Average trip duration (minutes)	NA	NA	NA	NA	20.1
Average trip length (miles)	NA	NA	NA	NA	NA
Modeled					
Average trip duration (minutes)	14.59	14.41	14.47	18.82	16.68*
Average trip length (miles)	7.15	6.92	6.73	8.82	8.01*

* Weighted average
NA = not available

Table 5-4: Trip Distribution Calibration Results—Non-Work Trip Purposes

	HBSCHOOL	HBSHOP	HBOTHER	NHB
Observed				
Average trip duration (minutes)	NA	NA	NA	NA
Average trip length (miles)	NA	NA	NA	NA
Modeled				
Average trip duration (minutes)	11.3	12.39	13.58	10.76
Average trip length (miles)	4.34	4.84	5.60	3.79

NA = not available

Trip Length Distribution Macro

A macro to automatically compute trip length distributions, calculate average trip distances and times, and calculate intrazonal trips by trip purpose was added. In the model interface, there is an output file parameter called “TLD Table” located in the output files of the Trip Distribution step. It reports out the average length, average time, total trips, intrazonal trips, and the percentage of intrazonal trips for all resident and visitor trip purposes. A sample file is shown below:

PURPOSE	AVGDIST	AVGTIME	TOTALTRIPS	INTRATRIPS	PERCENTINT
HBW_INC1_pk	7.15	14.59	5,020.3	81.6	0.016
HBW_INC2_pk	6.92	14.41	5,663.1	107.1	0.019
HBW_INC3_pk	6.73	14.47	15,269.3	343.4	0.022
HBW_INC4_pk	8.82	18.22	37,051.1	661.6	0.018
HBSCH_opk	4.34	11.30	24,951.2	1,016.5	0.041
HBSHOP_opk	4.84	12.39	35,623.1	1,462.8	0.041
HBOTHER_opk	5.60	13.58	145,268.8	5,543.7	0.038
NONHB_opk	3.79	10.76	109,336.6	12,547.7	0.115

Douglas County/Carson City Regional Travel Demand Model

Table 5-5 describes each field in the output trip length distribution table.

Table 5-5: Trip Length Distribution Table (tldtable.bin)

FIELD	DESCRIPTION
PURPOSE	Trip purpose, including total home-work and work-other trips aggregated by market segment
AVGDIST	Average trip distance in hundredths of miles
AVGTIME	Average trip time in hundredths of minutes
TOTALTRIPS	Total trips for trip purpose
INTRATRIPS	Intrazonal trips for trip purpose
PERCENTINT	Percentage of total trips that are intrazonal trips

6. MODE SPLIT

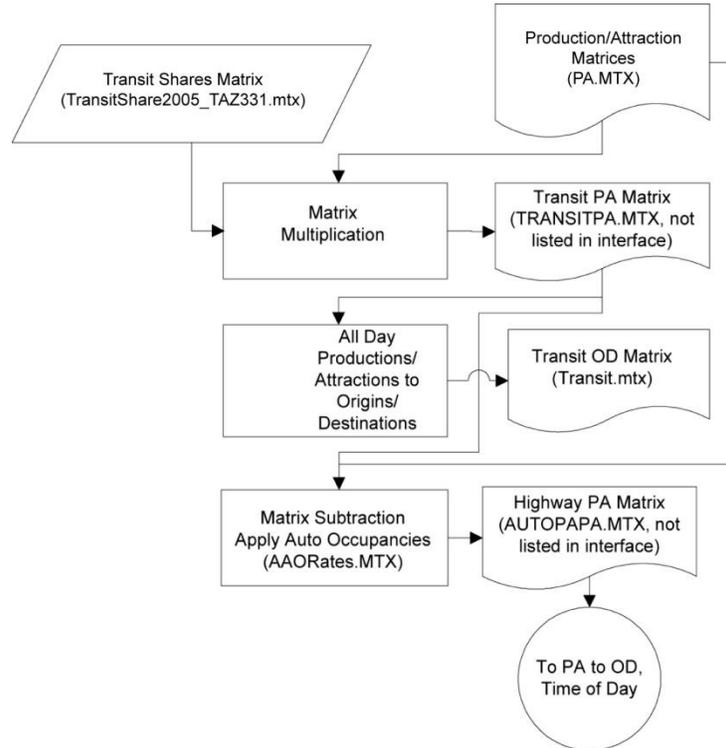

Introduction

In the travel models for the Douglas County and Carson City model, district-to-district mode split factors are applied to trip tables resulting from the trip distribution step to estimate person trips by transit and person trips by auto. Transit shares are applied to the total person trips to separate out the transit trips and the auto trips. Auto occupancy factors are then applied to convert person trips made in automobiles to vehicle trips for traffic assignment. For the travel models, aggregate auto occupancy models that account for differing characteristics of production zones were developed.

The auto occupancy models do not account for trip interchange characteristics such as travel time savings on HOV lanes or trip attraction zone characteristics (parking cost or special carpool parking preferences). Such characteristics might be taken into account when a mode choice model is developed or adopted for the region.

The transit share matrix for the Travel demand model was set to zero. This meant that all person trips coming out of the trip distribution was auto related. However, during the model development, a transit share matrix was added to so that in future transit share of the total person trips could be accounted for. Currently the model does not have any transit share associated with it.

Home-Based Auto Occupancy Models

A basic assumption underlying the estimation of the home-based average auto occupancy models is that the average auto occupancies are largely a function of socioeconomic characteristics in the production zone. The resulting models do not account for changes in average auto occupancy due to network characteristics (such as travel time or travel cost); however, they do account for variations in average household size, and when meaningful, different income levels. The models do not account for variation in auto occupancies at the attraction end of the trip, except as indirectly affected by the variation in average auto occupancies of trips attracted to the zone.

The home-based average auto occupancy models are an improvement over the typical state of the practice of using average regional auto occupancies by trip purpose for home-based trips. Experience in other areas has shown that auto occupancies vary throughout the region. The implementation of the home-based average auto occupancy models will cause variation in auto occupancies by production zone throughout the region.

The calibration of the home-based auto occupancy models was performed in a manner analogous to the calibration of trip production models. Specifically, cross-classification models were calibrated by summarizing and comparing average auto occupancies by trip purpose stratified by the income level and household size of the trip maker. Trip purposes and average auto occupancies were based on information reported by the auto driver for all purposes except home-based school. Adjacent cells in the cross-classification tables were combined to remove non-significant variation.

Tables 6-1 through 6-4 summarize the home-based average auto occupancies by trip purpose. The rates shown in Tables 6-1 through 6-4 are included in the TransCAD trip generation program implementation procedures since the zonal distributions of trip productions for households stratified by income group and household size are available within the trip generation routines. The TransCAD trip generation routine calculates and reports average home-based auto occupancies by trip purpose for each production zone.

Home-Based Work Average Auto Occupancies

No significant variation in the home-based work average auto occupancies was observed in the data when stratified by income group and household size of the trip maker. As a result, the home-based work average auto occupancy model defaults to the estimated regional average auto occupancy for home-based work trips. The lack of variation by income group and household size is reasonable considering that home-based work trips are less discretionary in nature than the other trip purposes.

Table 6-1: Home-Based Work Average Auto Occupancy Model

INCOME GROUP	HOUSEHOLD SIZE				
	1	2	3	4	5+
Low (less than \$19,999)	1.06	1.06	1.06	1.06	1.06
Lower-middle (\$20,000–\$29,999)	1.06	1.06	1.06	1.06	1.06
Upper-middle (\$30,000–\$49,499)	1.06	1.06	1.06	1.06	1.06
High (\$50,000 or more)	1.06	1.06	1.06	1.06	1.06

Home-Based School Average Auto Occupancies

Table 6-2: Home-Based School Average Auto Occupancy Model

INCOME GROUP	HOUSEHOLD SIZE				
	1	2	3	4	5+
Low (less than \$19,999)	1.00	1.00	1.28	1.28	1.28
Lower-middle (\$20,000–\$29,999)	1.00	1.00	1.28	1.28	1.28
Upper-middle (\$30,000–\$49,499)	1.00	1.00	1.00	1.28	1.28
High (\$50,000 or more)	1.00	1.00	1.00	1.28	1.28

Home-Based Shop Average Auto Occupancies

As can be seen in Table 6-3, home-based shop average auto occupancies vary by both income group and household size. As might be expected, average occupancies increase with increasing household size, since it is more likely for an extra household member to “ride along” on the shopping trip or be required for the shopping (for example, clothes shopping). There is also a tendency for average auto occupancies to decrease as income increases. This is probably due to increasing independence of household members as incomes increase. For many households, higher incomes are obtained as the employed household members become older, and probably have older children leading more independent lives. In addition, higher income households are more likely to own multiple vehicles.

Table 6-3: Home-Based Shop Average Auto Occupancy Model

INCOME GROUP	HOUSEHOLD SIZE				
	1	2	3	4	5+
Low (less than \$19,999)	1.07	1.35	2.20	2.20	2.20
Lower-middle (\$20,000–\$29,999)	1.07	1.35	1.39	1.91	1.91
Upper-middle (\$30,000–\$49,499)	1.07	1.35	1.39	1.91	1.91
High (\$50,000 or more)	1.07	1.35	1.39	1.56	1.56

Home-Based Other Average Auto Occupancies

As with the home-based shop average auto occupancies, home-based other average occupancies vary by income group and household size. The variation is similar to that noted for the home-based shop trip purpose: average auto occupancies tend to increase with increasing household size and decrease with increasing income. The reasons for the variation are probably the same as for home-based shop trips.

Table 6-4: Home-Based Other Average Auto Occupancy Model

INCOME GROUP	HOUSEHOLD SIZE				
	1	2	3	4	5+
Low (less than \$19,999)	1.26	1.62	1.92	1.93	3.25
Lower-middle (\$20,000–\$29,999)	1.11	1.62	1.92	1.93	2.20
Upper-middle (\$30,000–\$49,499)	1.11	1.48	1.58	1.93	2.20
High (\$50,000 or more)	1.11	1.34	1.58	1.93	2.20

Non-Home-Based Auto Occupancy Models

The Non-Home Based Auto Occupancy models developed for the Las Vegas region were used. A brief discussion of the calibration procedures used for the non-home-based average auto occupancy model is described below.

Since the actual location of the trip ends did not necessarily occur in the home zone locations of the trip makers, the use of demographic data to estimate average auto occupancies was illogical. Rather, non-home-based trips were related to the number of people (potential travelers) and the number of vehicles available in the zones where the non-home-based trips actually originated. This assertion was straightforward—the more potential travelers there were per vehicle, the higher the average auto occupancy for non-home-based trips.

District-based regression techniques were used to estimate the non-home-based auto occupancy model. Home-based person trips and home-based vehicle trips from the home-interview survey data were aggregated to 18 districts defined for the Las Vegas Valley area. Likewise, non-home-based person trips in autos and non-home-based auto trips were summarized to the production district of the actual trip. Note that person trips in autos were based on the auto occupancies reported by the auto drivers. Based on these data, the non-home-based average auto occupancies and the average “persons per auto arriving” were calculated for each district. The best regression models in terms of explanatory power (R^2) and significance of model coefficients were:

$$\text{NHBAO} = 0.36 + 0.83 * \text{PPAARR} \qquad R^2 = .60$$

where:

NHBAO = the non-home-based average auto occupancy

PPAARR = the persons per auto arriving for home-based non-work trip purposes

The R^2 value for the model suggests that it explains about 60 percent of the variance in non-home-based auto occupancies on a district basis. It should be noted that the model coefficients are similar to those estimated for several other cities using this type of aggregate non-home-based auto occupancy model.

If the PPAARR takes on the minimum value of 1.0, the resulting non-home-based average auto occupancies will be 1.19. At the regional average for PPAARR (1.41), the resulting modeled non-home-based average auto occupancy is 1.54. Note that this is slightly higher than the observed regional estimate for the non-home-based average auto occupancy, 1.49. This difference occurs because one of the observations used for the estimation of the model was excluded from the model estimation as an outlier (see Figure 6-1). While the model coefficients could have been

Douglas County/Carson City Regional Travel Demand Model

scaled to more closely match the regional non-home-based average auto occupancy when the regional average PPAARR was input, the changes were very small and well within the level of accuracy of the model.

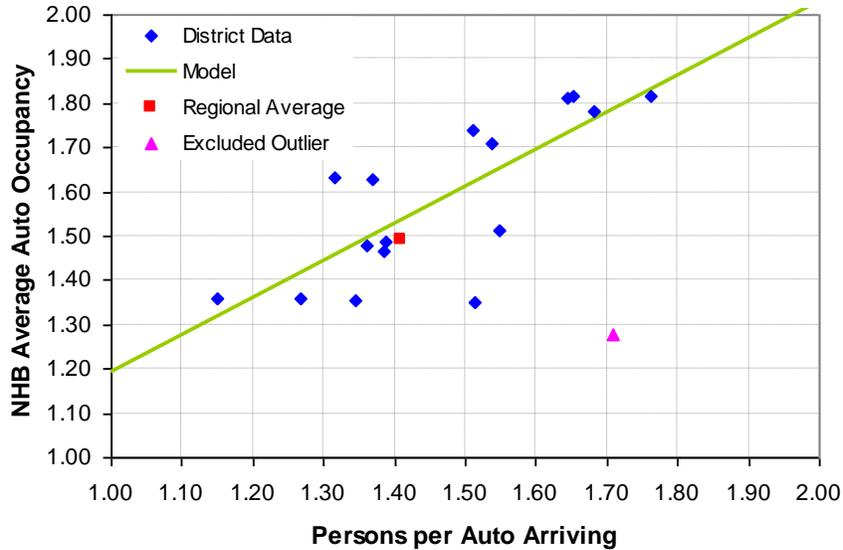

Figure 6-1: Non-Home-Based Average Auto Occupancy Calibration Data and Model

Since the district-based regressions were based on rates rather than total trips or some other extensive measure, there is no difficulty with applying the model at different geographic levels. When district based regression is used to estimate trip generation models, the constant must be factored out of the resulting model or the model must be run at the district level to give reasonable results. The above models can be applied at the zone level with no adjustment.

The number of persons per vehicle arriving at each zone can be determined from the results of the person trip distributions of home-based trips combined with the trip tables resulting from the applications of the home-based mode split and home-based auto occupancy models. In effect, the column sums of the home-based person trip matrices provide the persons arriving in each zone, and the column sums of the home-based vehicle trip matrices provide the number of vehicles arriving in each zone.

7. TRIP ASSIGNMENT

Production/Attraction to Origin/Destination and Time of Day Distribution

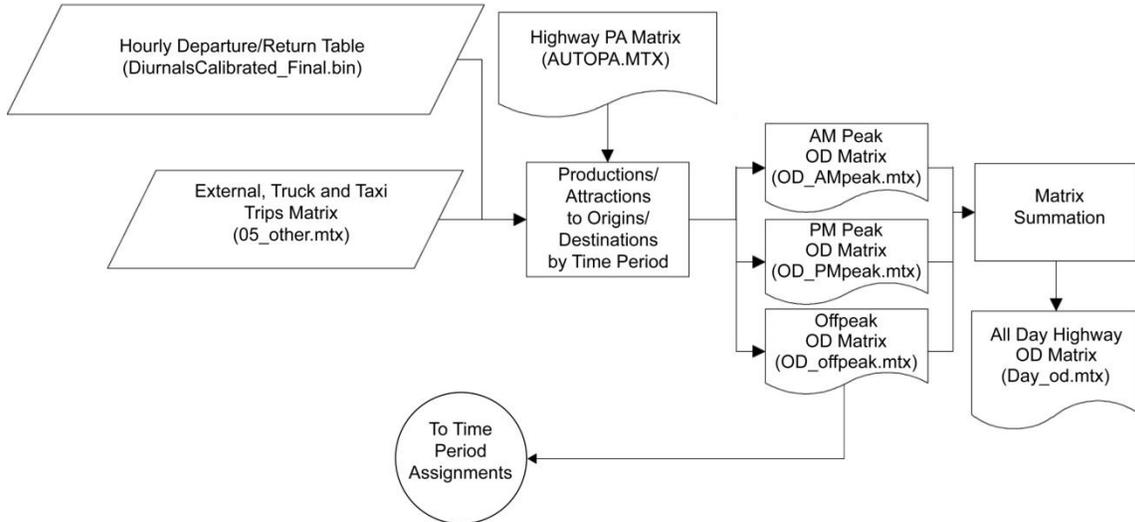

The Production/Attraction (PA) to Origin/Destination (OD) and time of day distribution process converts all auto PA person trip matrices into vehicle OD matrices by time period. For the Travel Demand Model, the 24 hour day was split into three time periods: 8 am to 9 am (AM Peak), 5 pm to 6 pm (PM Peak) and Offpeak (Rest).

Once the time periods were established, departure and return trip percentages were estimated for each time period. The percentages were estimated from a variety of sources and then the departure and return trip percentages were then adjusted to conform with the hourly counts. Table 7-1 lists the departure and return percentages for each trip purpose for each hour of the day.

Other Trips Matrix

The input Other trips matrix consists of an estimated PA matrix of external-to-external and truck trips. The External to Internal and External to External for the base year was estimated based on the 2014 count information at the external stations. There are currently no truck trips in the model, but however a truck trip matrix was provided as part of the model development process. There are currently seven External/Gateway stations in the model.

Douglas County/Carson City Regional Travel Demand Model

Table 7-1: Departure and Return Percentages by Time of Day and Trip Purpose (Diurnalscalibrated_final. bin)

HOUR	DEP HBW	RET HBW	DEP HBSCH	RET HBSCH	DEP HBSHOP	RET HBSHOP	DEP HBOTHER	RET HBOTHER	DEP NHB	RET NHB	DEP EXT	RET EXT	DEP TRUCK	RET TRUCK
0	0.00	0.00	0.00	0.00	0.00	0.00	0.00	0.00	0.00	0.00	0.00	0.00	0.00	0.00
1	0.00	0.00	0.00	0.00	0.00	0.00	0.00	0.00	0.00	0.00	0.00	0.00	0.00	0.00
2	0.00	0.00	0.00	0.00	0.00	0.00	0.00	0.00	0.00	0.00	0.00	0.00	0.00	0.00
3	0.00	0.00	0.00	0.00	0.00	0.00	0.00	0.00	0.00	0.00	0.00	0.00	0.00	0.00
4	0.00	0.00	0.00	0.00	0.00	0.00	0.00	0.00	0.00	0.00	0.00	0.00	0.00	0.00
5	0.00	0.00	0.00	0.00	0.00	0.00	0.00	0.00	0.00	0.00	0.00	0.00	0.00	0.00
6	0.00	0.00	0.00	0.00	0.00	0.00	0.00	0.00	0.00	0.00	0.00	0.00	0.00	0.00
7	0.00	0.00	0.00	0.00	0.00	0.00	0.00	0.00	0.00	0.00	0.00	0.00	0.00	0.00
8	9.86	0.24	10.38	0.04	2.43	0.99	2.43	0.99	2.08	2.11	2.94	1.70	2.94	1.70
9	0.00	0.00	0.00	0.00	0.00	0.00	0.00	0.00	0.00	0.00	0.00	0.00	0.00	0.00
10	0.00	0.00	0.00	0.00	0.00	0.00	0.00	0.00	0.00	0.00	0.00	0.00	0.00	0.00
11	0.00	0.00	0.00	0.00	0.00	0.00	0.00	0.00	0.00	0.00	0.00	0.00	0.00	0.00
12	0.00	0.00	0.00	0.00	0.00	0.00	0.00	0.00	0.00	0.00	0.00	0.00	0.00	0.00
13	0.00	0.00	0.00	0.00	0.00	0.00	0.00	0.00	0.00	0.00	0.00	0.00	0.00	0.00
14	0.00	0.00	0.00	0.00	0.00	0.00	0.00	0.00	0.00	0.00	0.00	0.00	0.00	0.00
15	0.00	0.00	0.00	0.00	0.00	0.00	0.00	0.00	0.00	0.00	0.00	0.00	0.00	0.00
16	0.00	0.00	0.00	0.00	0.00	0.00	0.00	0.00	0.00	0.00	0.00	0.00	0.00	0.00
17	0.76	9.99	1.29	2.75	2.99	4.96	2.99	4.96	7.16	7.16	3.76	3.44	3.76	3.44
18	0.00	0.00	0.00	0.00	0.00	0.00	0.00	0.00	0.00	0.00	0.00	0.00	0.00	0.00
19	0.00	0.00	0.00	0.00	0.00	0.00	0.00	0.00	0.00	0.00	0.00	0.00	0.00	0.00
20	0.00	0.00	0.00	0.00	0.00	0.00	0.00	0.00	0.00	0.00	0.00	0.00	0.00	0.00
21	0.00	0.00	0.00	0.00	0.00	0.00	0.00	0.00	0.00	0.00	0.00	0.00	0.00	0.00
22	0.00	0.00	0.00	0.00	0.00	0.00	0.00	0.00	0.00	0.00	0.00	0.00	0.00	0.00
23	39.38	39.77	38.33	47.21	44.57	44.04	44.57	44.04	40.76	40.73	43.30	44.86	43.30	44.86
TOTAL	50.00	50.00	50.00	50.00	50.00	50.00	50.00	50.00	50.00	50.00	50.00	50.00	50.00	50.00

Traffic Assignment

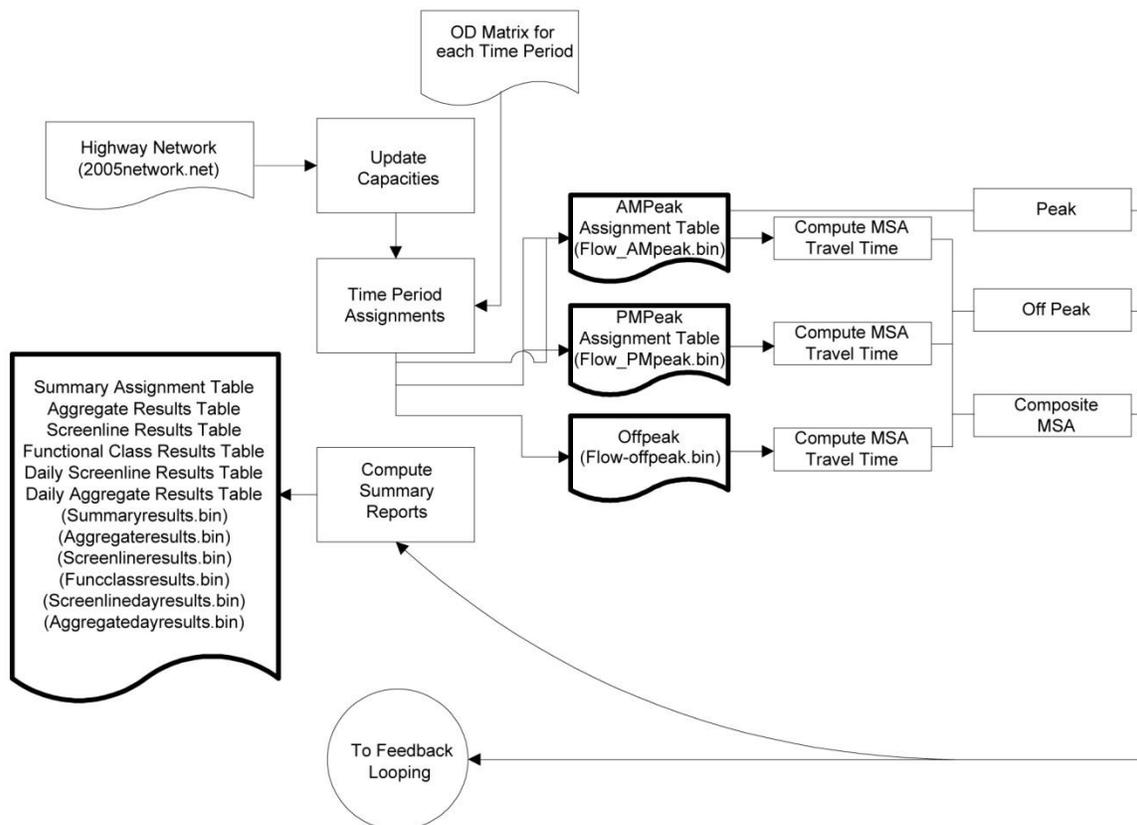

In this step, each of the time period OD matrices is assigned to the highway network. Different link capacities are computed for each time period assignment. The User Equilibrium method is utilized for each assignment with a default number of 40 iterations per assignment. After each assignment, a flow result table for each time period is generated. After all time period assignments are completed, several report tables are calculated:

- A summary assignment table that groups all time period assignments into one table, calculates a daily flow total, and compares all link counts to the flow totals for all time periods plus the daily total.
- An aggregate results table that compares link counts to flow totals grouped by functional class and time period.
- A screenline results table that compares links counts to flow totals grouped by screenline number and time period.
- A functional class results table that calculates total vehicle miles traveled (VMT) and average speeds by functional class.
- A screenline results table comparing link counts to flow totals. Unlike the previous screenline table, the counts used for this comparison come from the NDOT AADT counts instead of the hourly counts, thus only a daily comparison is available for this table.
- An aggregate results table that compares link counts to flow totals. Unlike the previous aggregate table, the counts used for this comparison come from the NDOT AADT counts instead of the hourly counts, thus only a daily comparison is available for this table.

Cold Start Flows and VMT

Cold start vehicle flows and VMT are also reported from the highway assignment. Used for air quality analysis, cold start flow represents the aggregate flow associated with only the first 505 seconds or other user-defined time period of travel in the network.

Feedback Looping

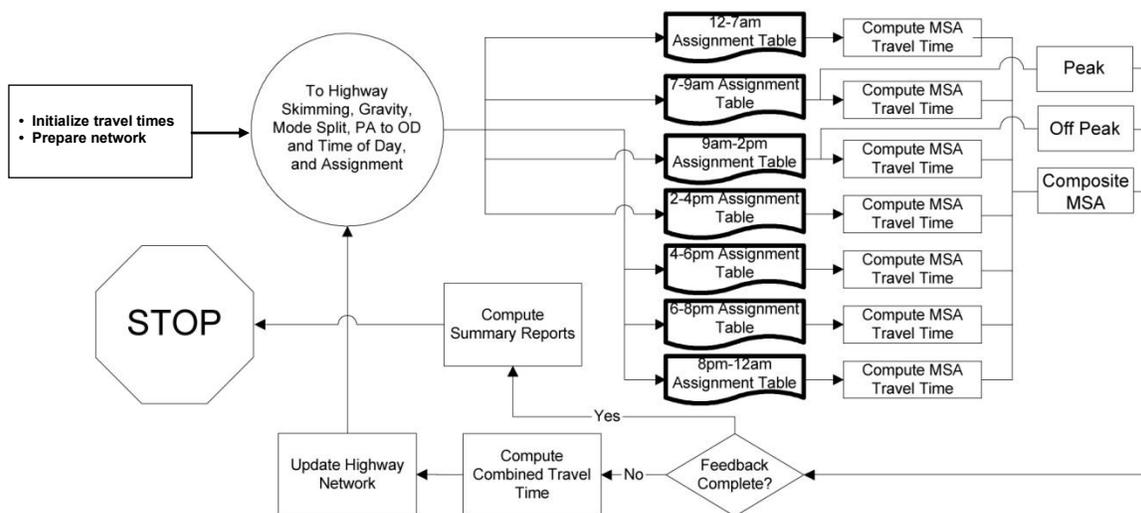

The feedback loop step uses the assignment model to calculate updated congested travel times. These congested travel times are then “fed back” into the network and the highway skim travel time matrix is re-calculated. Since this would change the results of the gravity model and any subsequent model that is in the stream process, all models are re-run with this updated information.

The purpose of a feedback loop is to generate realistic congested travel times so that the gravity model allocates trips to zones with more accuracy than by using free-flow travel times. The feedback loop is repeated several times until either the output flow volumes between successive loop iterations are within a convergence criteria or the number of iterations exceeds a specified amount. For resident trips, peak skims are used for home-based work trips while off peak skims are used for all other trip purposes.

The method of Multiple Successive Averages (MSA) is used to calculate the updated travel times used to feed back into highway skim. In this method, the calculated congested travel time by link is the combined average of loaded travel times calculated from previous feedback user-equilibrium iterations. The methodology is similar to the base method used for calculating volumes between iterations of user-equilibrium. This method of computing congested travel times has been shown in field tests to converge faster than the simpler method of feeding in directly the congested travel times resulting from the current user-equilibrium assignment.

Assignment Reports

Table 7-2 lists all the fields in the AMPEAK hour, PMPEAK hour and the OFFPEAK time period.

Douglas County/Carson City Regional Travel Demand Model

Table 7-2: Time Period Flow Table (FLOW_AMPEAK.BIN, FLOW_PMPEAK.BIN.BIN and FLOW_OFFPEAK.BIN)

FIELD	DESCRIPTION
ID1	Link ID
AB_Flow	Volume Flow in AB direction
BA_Flow	Volume Flow in BA direction
TOT_Flow	Total Volume Flow in both directions
AB_Time	Congested travel time in AB direction
BA_Time	Congested travel time in BA direction
MAX_Time	Congested travel time in both directions
AB_voc	Volume/Capacity ratio in AB direction
BA_voc	Volume/Capacity ratio in BA direction
MAX_voc	Volume/Capacity ratio in both directions
AB_vmt	Vehicle miles of travel in AB direction
BA_vmt	Vehicle miles of travel in BA direction
TOT_vmt	Vehicle miles of travel in both directions
AB_vht	Vehicle hours of travel in AB direction
BA_vht	Vehicle hours of travel in BA direction
TOT_vht	Vehicle hours of travel in both directions
AB_speed	Congested Speed in AB direction
BA_speed	Congested Speed in BA direction
AB_Cold_Flow	Volume Flow in the first 505 seconds of travel in AB direction
BA_Cold_Flow	Volume Flow in the first 505 seconds of travel in BA direction
TOT_Cold_Flow	Total Cold Flow in both directions
AB_Cold_V_Dist_T	Cold Flow VMT in AB direction
BA_Cold_V_Dist_T	Cold Flow VMT in BA direction

Table 7-3 describes all the fields in the summary reports file.

A functional classification report (see Table 7-4) outputs the daily Vehicle Miles traveled, the Total Daily flow and the Average speeds. The data is summarized by the different facility types that are present in the model.

Table 7-3: Results Table (Summaryresults.bin)

FIELD	DESCRIPTION
ID1	Link IDs
AB_TIME_XXXXXX / BA_TIME_XXXXXX	Congested Link travel times by direction and time period
Total_TIME_XXXXX	Total Congested travel time by time period
AB_FLOW_XXXXX / BA_FLOW_XXXXX	Assigned Link flows by direction and time period
Total_FLOW_XXXXX	Total Assigned Link Flows by time period
AB_DAY_FLOW / BA_DAY_FLOW	Total Daily Flow by direction
TOT_DAY_FLOW	Total Daily Flow
AB_VOC_DAY / BA_VOC_DAY	Daily Volume -to-Capacity ration by direction
DAY_VMT	Total Daily VMT
AVG_DAY_SPEED	Daily Average speed
AB_VOC_XXXXX / BA_VOC_XXXXX	Volume -to-Capacity ration by direction and time period

XXXXX = Time period

Table 7-4: Functional Class Results Table (FuncclassResults.bin)

FIELD	DESCRIPTION
FTYPE_NUM	Functional classification
DAY_VMT	Total daily vehicle miles of travel
TOT_DAY_FLOW	Total daily flow
[Avg AVG_DAY_SPEED]	Daily average speed

Traffic Assignment Validation

The model validation targets (tolerances) are based on several criteria which are as follows.

- Compare modeled traffic volumes to observed traffic counts across all facility types by percent volume deviation, with the maximum desirable deviation being around 10 percent.
- Use the Federal Highway Administration recommended error limits for total difference (model – count) by functional classification as a region-wide validation:
 - Freeways less than 7 percent error
 - Expressways less than 10 percent error
 - Arterials less than 15 percent error
 - Collectors less than 25 percent error
 - Frontage roads less than 25 percent error

Douglas County/Carson City Regional Travel Demand Model

- Use the percent error by volume range recommended by the NCHRP report 255, as follows:
 - < 5000 Volume Range: 60 percent deviation
 - > 4999 and <10000 Volume Range: 40 percent deviation
 - > 9999 and <15000 Volume Range: 32 percent deviation
 - >14999 and <20000 Volume Range: 29 percent deviation
 - >19999 and <25000 Volume Range: 27 percent deviation
 - >24999 and <30000 Volume Range: 25 percent deviation
- Screenlines should be within 10 percent of the observed counts.

The model validation statistics are as follows.

- A comparison of all counts across facility types is well within the acceptable tolerance of 10 percent. The daily is within 3 percent; the AM peak is within 3 percent; and the PM peak is within 8 percent.
- The daily comparison shows that the freeways are at 1 percent (within the acceptable range of 7 percent), arterials are at 7 percent (within the acceptable range of 15 percent), and collectors are at 13 percent (within the acceptable limits of 25 percent).
- The daily comparison shows that the volume ranges are within acceptable criteria, with the highest being 13 percent, which is well below the threshold of 27 percent.
- Most of the 29 screenlines for the daily comparisons are within 10 percent of the counts.

The 2014 validation screenline locations are illustrated on Figures 7-1 and 7-2. The validation results as compared to the counts are shown in Tables 7-5 through 7-7. The comparison is made for the AM Peak, PM Peak, OFFPEAK and Daily traffic volumes. The overall total percent deviation from the screenline is 5 percent for AM, 4 percent for PM, -8 percent for the OFFPEAK and -6 percent for the Daily. Individual screenlines may experience more variations for the different time periods.

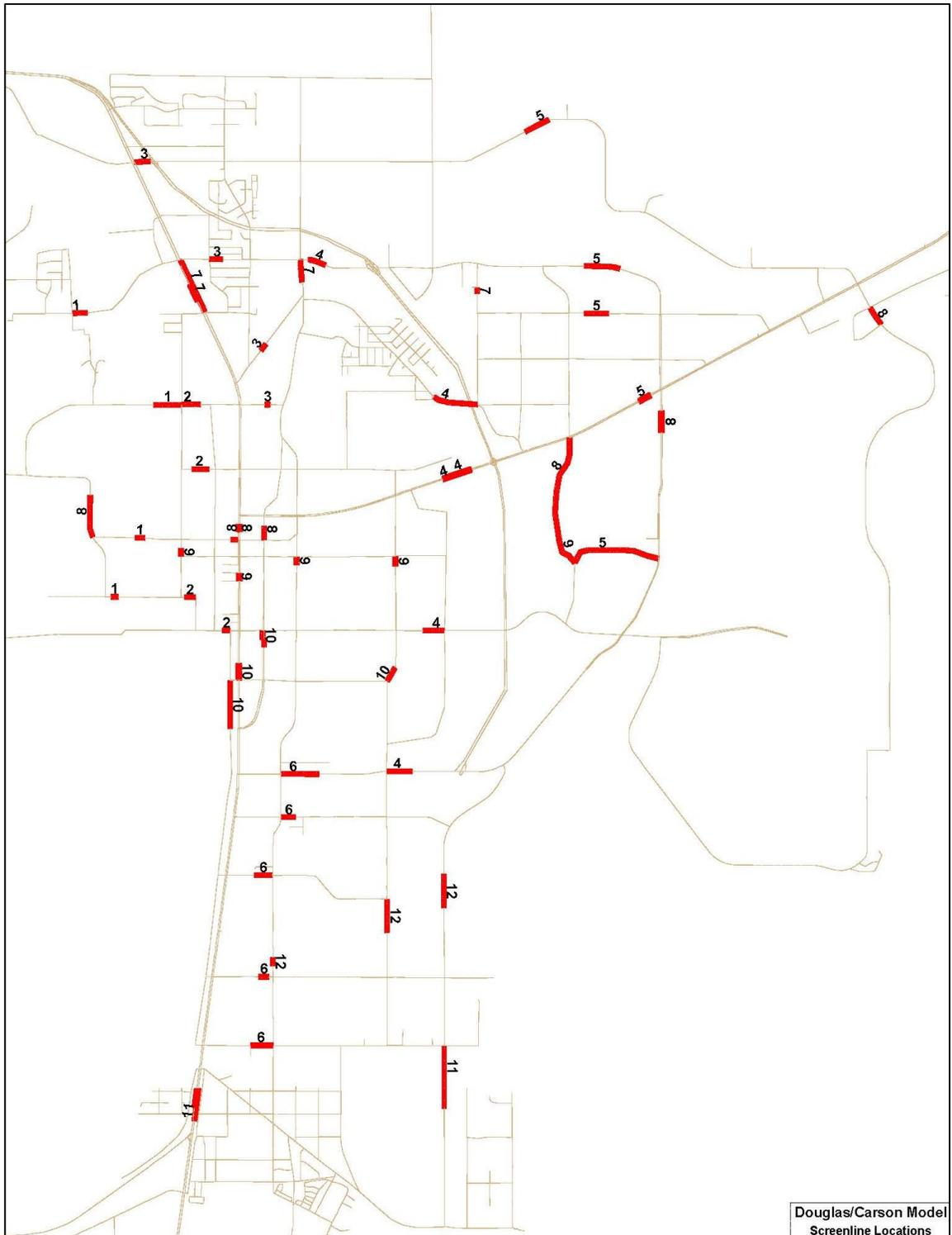

Figure 7-1: Screenline Locations in Carson City

Douglas County/Carson City Regional Travel Demand Model

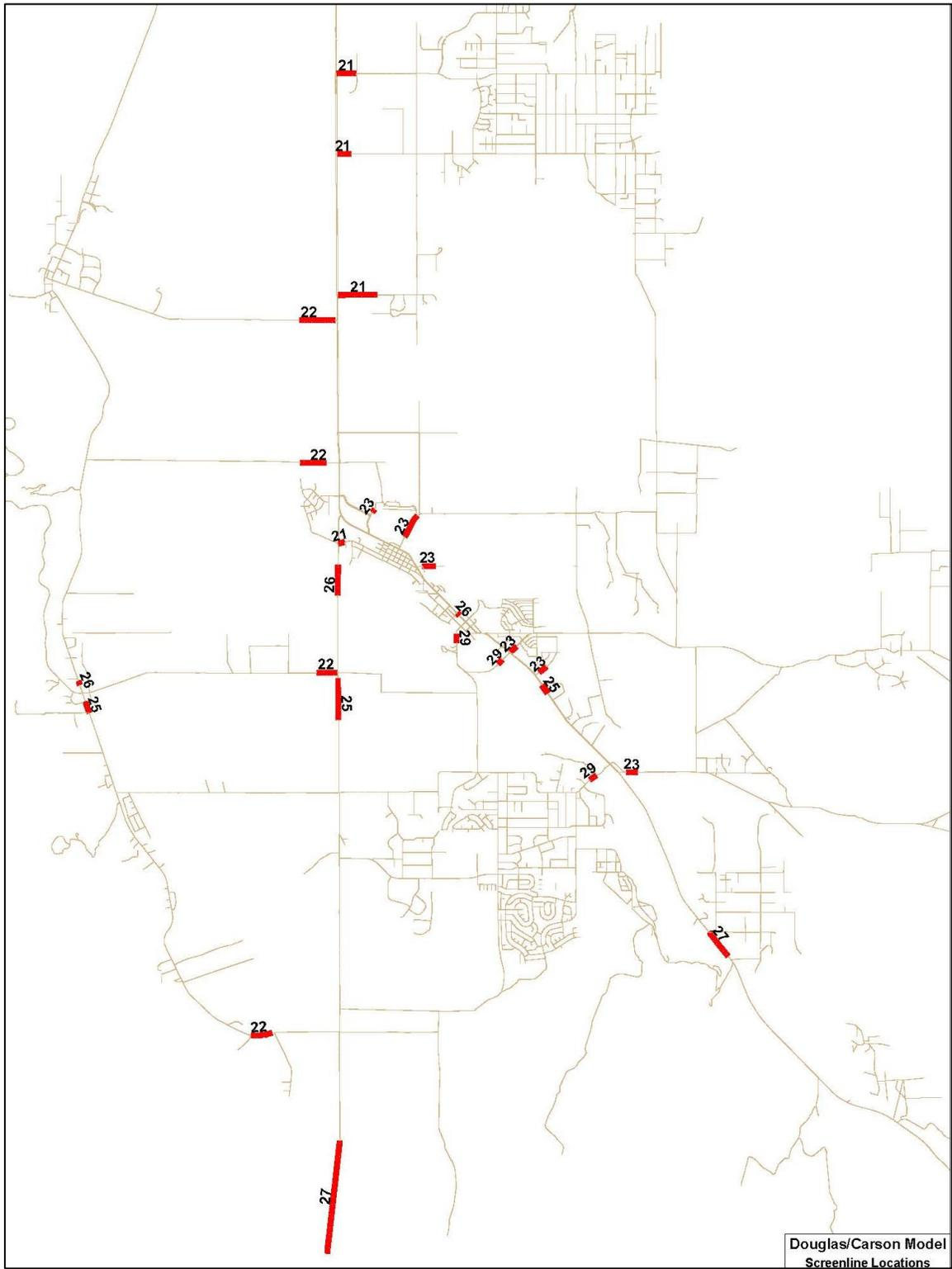

Figure 7-2: Screenline Locations in Douglas County

Douglas County/Carson City Regional Travel Demand Model

Table 7-5: 2014 Validation—Daily Volumes Comparisons to Counts

	COUNTS	MODEL VOLUMES	TRAFFIC COUNTS	MODEL/COUNT RATIO
FACILITY				
Gateways	14	94,220	93,749	1.01
Minor Arterials	158	314,887	315,997	1.00
Major Arterials	74	746,708	700,990	1.07
Freeways/Ramps	12	85,255	84,767	1.01
Expressways	2	34,897	29,517	1.18
Collectors/Local Roads	84	94,597	108,308	0.87
Total	344	1,370,564	1,333,328	1.03
FHWA RANGE				
Link Counts < 5000	271	528,976	507,501	1.04
Link Counts < 10000	32	234,006	224,109	1.04
Link Counts < 15000	29	368,894	362,861	1.02
Link Counts < 20000	7	114,818	119,699	0.96
Link Counts < 25000	3	69,195	61,217	1.13
Link Counts < 30000	2	54,675	57,942	0.94
Link Count > 0	344	1,370,563	1,333,328	1.03
SCREENLINE				
Screenline 1	8	15,454	15,775	0.98
Screenline 2	10	22,563	17,712	1.27
Screenline 3	8	20,773	26,720	0.78
Screenline 4	10	71,892	84,830	0.85
Screenline 5	10	36,062	35,390	1.02
Screenline 6	10	35,302	41,460	0.85
Screenline 7	6	34,122	31,087	1.10
Screenline 8	12	48,196	47,020	1.03
Screenline 9	10	36,222	37,379	0.97
Screenline 10	8	44,778	41,411	1.08
Screenline 11	4	56,673	59,524	0.95
Screenline 12	6	18,238	16,482	1.11
Screenline 21	8	23,067	19,101	1.21
Screenline 22	8	7,771	7,863	0.99
Screenline 23	12	17,570	18,194	0.97
Screenline 25	6	31,622	31,812	0.99
Screenline 26	6	38,555	39,113	0.99
Screenline 27	4	11,308	11,519	0.98
Screenline 29	6	22,427	21,049	1.07
Total	152	592,595	603,441	0.98

Douglas County/Carson City Regional Travel Demand Model

Table 7-6: 2014 Validation—AM Peak Volumes Comparisons to Counts

	COUNTS	MODEL VOLUMES	TRAFFIC COUNTS	MODEL/COUNT RATIO
FACILITY				
Gateways	14	4,372	5,778	0.76
Minor Arterials	158	16,595	18,133	0.92
Major Arterials	74	43,401	37,215	1.17
Freeways/Ramps	12	5,287	5,030	1.05
Expressways	2	2,141	1,825	1.17
Collectors/Local Roads	84	5,244	6,812	0.77
Total	344	77,040	74,793	1.03
SCREENLINE				
Screenline 1	8	891	897	0.99
Screenline 2	10	1,312	1,312	1.00
Screenline 3	8	1,115	1,422	0.78
Screenline 4	10	4,301	4,839	0.89
Screenline 5	10	1,936	1,867	1.04
Screenline 6	10	2,364	2,293	1.03
Screenline 7	6	1,852	1,424	1.30
Screenline 8	12	2,647	2,207	1.20
Screenline 9	10	2,082	1,865	1.12
Screenline 10	8	2,500	1,829	1.37
Screenline 11	4	3,497	3,160	1.11
Screenline 12	6	798	886	0.90
Screenline 21	8	1,359	1,242	1.09
Screenline 22	8	430	528	0.81
Screenline 23	12	1,070	1,418	0.75
Screenline 25	6	1,831	1,830	1.00
Screenline 26	6	2,303	2,255	1.02
Screenline 27	4	604	837	0.72
Screenline 29	6	1,275	1,333	0.96
Total	152	34,167	33,444	1.02

Douglas County/Carson City Regional Travel Demand Model

Table 7-7: 2014 Validation—PM Peak Volumes Comparison to Counts

	COUNTS	MODEL VOLUMES	TRAFFIC COUNTS	MODEL/COUNT RATIO
FACILITY				
Gateways	14	6,783	7,177	0.95
Minor Arterials	158	30,400	27,707	1.10
Major Arterials	74	64,857	57,753	1.12
Freeways/Ramps	12	7,214	6,775	1.06
Expressways	2	3,029	2,490	1.22
Collectors/Local Roads	84	9,189	10,207	0.90
Total	344	121,472	112,109	1.08
SCREENLINE				
Screenline 1	8	1,426	1,476	0.97
Screenline 2	10	2,120	1,413	1.50
Screenline 3	8	2,106	2,196	0.96
Screenline 4	10	6,403	7,125	0.90
Screenline 5	10	2,914	2,904	1.00
Screenline 6	10	3,055	3,450	0.89
Screenline 7	6	2,969	2,718	1.09
Screenline 8	12	4,366	4,020	1.09
Screenline 9	10	3,401	3,143	1.08
Screenline 10	8	4,148	3,586	1.16
Screenline 11	4	5,109	5,071	1.01
Screenline 12	6	1,960	1,654	1.19
Screenline 21	8	2,138	1,572	1.36
Screenline 22	8	664	613	1.08
Screenline 23	12	1,502	1,773	0.85
Screenline 25	6	2,840	2,494	1.14
Screenline 26	6	3,386	3,144	1.08
Screenline 27	4	901	1,151	0.78
Screenline 29	6	2,010	1,873	1.07
Total	152	53,418	51,376	1.04

The 2014 model results for the vehicle hours traveled (VHT) and vehicle miles traveled (VMT) are shown in the Tables 7-8 through 7-10. The VMT and VHT are stratified by facility type and area type and are shown for the different time periods such as; AM, PM, OFFPEAK and daily. They are also summarized by county for the same time periods.

Douglas County/Carson City Regional Travel Demand Model

Table 7-8: Vehicle Miles Traveled and Vehicle Hours Traveled by Time Period—All Jurisdictions (2014)

2014 VALIDATION				ALL JURISDICTIONS/BOUNDARIES									
GROUPING	NUM LINKS	AMPEAK			PMPEAK			OFFPEAK			DAILY		
		VMT	VHT	AVG SPEED	VMT	VHT	AVG SPEED	VMT	VHT	AVG SPEED	VMT	VHT	AVG SPEED
ALL LINKS	7,868	143,061	3,561	40.17	226,334	6,285	36.01	2,228,878	57,947	38.46	2,598,273	67,794	38.33
ALL, NO CENTROIDS	7,233	133,983	3,198	41.89	211,114	5,676	37.19	2,091,590	52,455	39.87	2,436,687	61,330	39.73
BY FACILITY TYPE:													
GATEWAY LINKS	7	1,651	33	50.00	2,561	51	50.00	31,364	627	50.00	35,576	712	50.00
SYSTEM RAMPS	0	0	0	0.00	0	0	0.00	0	0	0.00	0	0	0.00
MINOR ARTERIALS	1,393	25,339	663	38.20	47,356	1,295	36.56	421,237	11,371	37.05	493,933	13,329	37.06
MAJOR ARTERIALS	941	63,426	1,534	41.35	93,224	2,617	35.63	968,759	25,076	38.63	1,125,409	29,226	38.51
RAMPS	36	286	10	29.72	412	16	26.40	3,831	138	27.74	4,529	163	27.73
FREEWAY	63	11,486	177	65.00	17,477	269	64.99	190,910	2,938	64.98	219,873	3,383	64.98
EXPRESSWAY	62	17,303	363	47.67	24,755	648	38.18	243,977	5,572	43.78	286,036	6,584	43.45
COLLECTORS	4,731	14,491	419	34.61	25,329	781	32.45	231,511	6,734	34.38	271,332	7,933	34.20
CENTROIDS	635	9,078	363	25.00	15,220	609	25.00	137,288	5,492	25.00	161,587	6,463	25.00
BY AREA TYPE:													
CBD	463	4,252	133	31.89	7,784	264	29.53	72,335	2,357	30.69	84,372	2,754	30.64
URBAN	4,853	86,616	2,202	39.34	134,569	4,003	33.62	1,307,654	35,742	36.59	1,528,840	41,947	36.45
RURAL	1,859	39,886	775	51.47	64,324	1,289	49.88	662,146	13,067	50.67	766,356	15,131	50.65
CENTROID	634	9,078	363	25.00	15,219	609	25.00	137,279	5,491	25.00	161,576	6,463	25.00
GATEWAY	7	1,651	33	50.00	2,561	51	50.00	31,364	627	50.00	35,576	712	50.00
BY FACILITY AND AREA TYPE													
SYSTEM RAMPS / CBD	0	0	0	0.00	0	0	0.00	0	0	0.00	0	0	0.00
MINOR ART / CBD	70	737	25	29.90	1,684	58	28.82	14,995	512	29.29	17,415	595	29.27
MAJOR ART / CBD	112	3,048	90	33.92	4,826	153	31.64	46,914	1,422	32.98	54,788	1,665	32.91
RAMPS / CBD	0	0	0	0.00	0	0	0.00	0	0	0.00	0	0	0.00
FREEWAY / CBD	0	0	0	0.00	0	0	0.00	0	0	0.00	0	0	0.00
EXPRESSWAY / CBD	0	0	0	0.00	0	0	0.00	0	0	0.00	0	0	0.00
COLLECTOR / CBD	281	467	19	24.79	1,274	53	24.22	10,427	422	24.69	12,168	494	24.64
SYS RAMPS / URBAN	0	0	0	0.00	0	0	0.00	0	0	0.00	0	0	0.00
MINOR ART / URBAN	868	13,928	401	34.70	25,165	778	32.36	224,707	6,805	33.02	263,800	7,984	33.04
MAJOR ART / URBAN	639	45,109	1,115	40.44	66,266	1,987	33.35	675,670	18,330	36.86	787,046	21,433	36.72
RAMPS / URBAN	33	286	10	29.72	412	16	26.40	3,831	138	27.74	4,529	163	27.73

Douglas County/Carson City Regional Travel Demand Model

Table 7-8: Vehicle Miles Traveled and Vehicle Hours Traveled by Time Period—All Jurisdictions (2014)

2014 VALIDATION		ALL JURISDICTIONS/BOUNDARIES											
GROUPING	NUM LINKS	AMPEAK			PMPEAK			OFFPEAK			DAILY		
		VMT	VHT	AVG SPEED	VMT	VHT	AVG SPEED	VMT	VHT	AVG SPEED	VMT	VHT	AVG SPEED
FREEWAY / URBAN	0	0	0	0.00	0	0	0.00	0	0	0.00	0	0	0.00
EXPRESSWAY / URBAN	43	14,740	313	47.11	21,004	554	37.89	207,092	4,787	43.26	242,835	5,654	42.95
COLLECTOR / URBAN	3,269	12,553	363	34.62	21,722	668	32.51	196,345	5,682	34.56	230,619	6,713	34.36
SYS RAMPS / RURAL	0	0	0	0.00	0	0	0.00	0	0	0.00	0	0	0.00
MINOR ART / RURAL	455	10,675	237	44.97	20,507	459	44.66	181,535	4,054	44.78	212,718	4,751	44.78
MAJOR ART / RURAL	140	13,707	274	49.97	20,279	410	49.51	228,317	4,677	48.82	262,303	5,361	48.93
RAMPS / RURAL	3	0	0	0.00	0	0	0.00	0	0	0.00	0	0	0.00
FREEWAY / RURAL	63	11,486	177	65.00	17,477	269	64.99	190,910	2,938	64.98	219,873	3,383	64.98
EXPRESSWAY / RURAL	19	2,564	50	51.18	3,751	94	39.88	36,885	786	46.95	43,200	930	46.47
COLLECTOR / RURAL	1,179	1,454	36	40.00	2,309	58	40.00	24,498	612	40.00	28,262	707	40.00
CENTROIDS	635	9,078	363	25.00	15,220	609	25.00	137,288	5,492	25.00	161,587	6,463	25.00
GATEWAY LINKS	7	1,651	33	50.00	2,561	51	50.00	31,364	627	50.00	35,576	712	50.00
JURISDICTIONS:													
1 : CARSON CITY	2,766	53,458	1,323	40.41	86,507	2,360	36.66	848,740	22,095	38.41	988,705	25,777	38.36
2 : DOUGLAS COUNTY	4,921	84,855	2,152	39.43	132,458	3,790	34.95	1,289,931	34,178	37.74	1,507,244	40,120	37.57
3 : EXTERNALS	181	4,748	87	54.77	7,369	135	54.50	90,208	1,675	53.86	102,324	1,897	53.95

Douglas County/Carson City Regional Travel Demand Model

Table 7-9: Vehicle Miles Traveled and Vehicle Hours Traveled by Time Period—Carson City (2014)

2014 VALIDATION		CARSON CITY JURISDICTIONS											
GROUPING	NUM LINKS	AMPEAK			PMPEAK			OFFPEAK			DAILY		
		VMT	VHT	AVG SPEED	VMT	VHT	AVG SPEED	VMT	VHT	AVG SPEED	VMT	VHT	AVG SPEED
ALL LINKS	2,766	53,458	1,323	40.41	86,507	2,360	36.66	848,740	22,095	38.41	988,705	25,777	38.36
ALL, NO CENTROIDS	2,394	49,923	1,181	42.26	80,385	2,115	38.01	794,792	19,937	39.87	925,100	23,233	39.82
BY FACILITY TYPE:													
GATEWAY LINKS	4	627	13	50.00	973	19	50.00	11,918	238	50.00	13,518	270	50.00
SYSTEM RAMPS	0	0	0	0.00	0	0	0.00	0	0	0.00	0	0	0.00
MINOR ARTERIALS	676	8,368	234	35.82	16,249	468	34.70	148,366	4,186	35.45	172,983	4,887	35.39
MAJOR ARTERIALS	511	27,890	682	40.92	41,274	1,157	35.68	419,882	11,239	37.36	489,046	13,077	37.40
RAMPS	36	286	10	29.72	412	16	26.40	3,831	138	27.74	4,529	163	27.73
FREEWAY	46	9,103	140	65.00	13,780	212	64.99	145,644	2,241	64.98	168,528	2,593	64.99
EXPRESSWAY	0	0	0	0.00	0	0	0.00	0	0	0.00	0	0	0.00
COLLECTORS	1,121	3,648	104	35.06	7,697	243	31.73	65,152	1,895	34.39	76,496	2,241	34.13
CENTROIDS	372	3,536	141	25.00	6,122	245	25.00	53,947	2,158	25.00	63,605	2,544	25.00
BY AREA TYPE:													
CBD	150	1,505	48	31.53	3,592	121	29.75	32,389	1,067	30.34	37,486	1,236	30.33
URBAN	1,699	30,960	797	38.83	50,634	1,492	33.94	475,435	13,325	35.68	557,029	15,614	35.67
RURAL	491	15,269	269	56.67	23,334	415	56.16	257,194	4,660	55.20	295,797	5,345	55.34
CENTROID	372	3,536	141	25.00	6,122	245	25.00	53,947	2,158	25.00	63,605	2,544	25.00
GATEWAY	4	627	13	50.00	973	19	50.00	11,918	238	50.00	13,518	270	50.00
BY FACILITY AND AREA TYPE													
SYSTEM RAMPS / CBD	0	0	0	0.00	0	0	0.00	0	0	0.00	0	0	0.00
MINOR ART / CBD	65	682	23	29.91	1,611	56	28.78	14,256	487	29.26	16,549	566	29.24
MAJOR ART / CBD	55	707	20	34.83	1,416	42	34.00	13,641	400	34.06	15,765	462	34.09
RAMPS / CBD	0	0	0	0.00	0	0	0.00	0	0	0.00	0	0	0.00
FREEWAY / CBD	0	0	0	0.00	0	0	0.00	0	0	0.00	0	0	0.00
EXPRESSWAY / CBD	0	0	0	0.00	0	0	0.00	0	0	0.00	0	0	0.00
COLLECTOR / CBD	30	115	5	25.00	565	23	24.44	4,492	180	24.99	5,171	207	24.93
SYS RAMPS / URBAN	0	0	0	0.00	0	0	0.00	0	0	0.00	0	0	0.00
MINOR ART / URBAN	551	6,277	180	34.97	12,443	364	34.23	108,405	3,126	34.67	127,125	3,669	34.64
MAJOR ART / URBAN	345	21,427	523	40.98	31,547	916	34.45	312,347	8,591	36.36	365,322	10,030	36.42
RAMPS / URBAN	33	286	10	29.72	412	16	26.40	3,831	138	27.74	4,529	163	27.73
FREEWAY / URBAN	0	0	0	0.00	0	0	0.00	0	0	0.00	0	0	0.00

Douglas County/Carson City Regional Travel Demand Model

Table 7-9: Vehicle Miles Traveled and Vehicle Hours Traveled by Time Period—Carson City (2014)

2014 VALIDATION		CARSON CITY JURISDICTIONS											
GROUPING	NUM LINKS	AMPEAK			PMPEAK			OFFPEAK			DAILY		
		VMT	VHT	AVG SPEED	VMT	VHT	AVG SPEED	VMT	VHT	AVG SPEED	VMT	VHT	AVG SPEED
EXPRESSWAY / URBAN	0	0	0	0.00	0	0	0.00	0	0	0.00	0	0	0.00
COLLECTOR / URBAN	770	2,970	85	34.79	6,231	197	31.64	50,852	1,470	34.60	60,053	1,752	34.28
SYS RAMPS / RURAL	0	0	0	0.00	0	0	0.00	0	0	0.00	0	0	0.00
MINOR ART / RURAL	60	1,409	31	45.00	2,195	49	44.98	25,705	572	44.94	29,308	652	44.95
MAJOR ART / RURAL	61	4,194	84	49.93	6,459	132	48.88	76,036	1,601	47.48	86,689	1,817	47.70
RAMPS / RURAL	3	0	0	0.00	0	0	0.00	0	0	0.00	0	0	0.00
FREEWAY / RURAL	46	9,103	140	65.00	13,780	212	64.99	145,644	2,241	64.98	168,528	2,593	64.99
EXPRESSWAY / RURAL	0	0	0	0.00	0	0	0.00	0	0	0.00	0	0	0.00
COLLECTOR / RURAL	321	563	14	40.00	901	23	40.00	9,808	245	40.00	11,272	282	40.00
CENTROIDS	372	3,536	141	25.00	6,122	245	25.00	53,947	2,158	25.00	63,605	2,544	25.00
GATEWAY LINKS	4	627	13	50.00	973	19	50.00	11,918	238	50.00	13,518	270	50.00
JURISDICTIONS:													
JURISDICTION TOTALS	2,766	53,458	1,323	40.41	86,507	2,360	36.66	848,740	22,095	38.41	988,705	25,777	38.36

Douglas County/Carson City Regional Travel Demand Model

Table 7-10: Vehicle Miles Traveled and Vehicle Hours Traveled by Time Period—Douglas County (2014)

2014 VALIDATION		DOUGLAS COUNTY JURISDICTIONS											
GROUPING	NUM LINKS	AMPEAK			PMPEAK			OFFPEAK			DAILY		
		VMT	VHT	AVG SPEED	VMT	VHT	AVG SPEED	VMT	VHT	AVG SPEED	VMT	VHT	AVG SPEED
ALL LINKS	4,921	84,855	2,152	39.43	132,458	3,790	34.95	1,289,931	34,178	37.74	1,507,244	40,120	37.57
ALL, NO CENTROIDS	4,658	79,313	1,930	41.09	123,360	3,426	36.00	1,206,590	30,844	39.12	1,409,262	36,201	38.93
BY FACILITY TYPE:													
GATEWAY LINKS	3	1,024	20	50.00	1,588	32	50.00	19,447	389	50.00	22,058	441	50.00
SYSTEM RAMPS	0	0	0	0.00	0	0	0.00	0	0	0.00	0	0	0.00
MINOR ARTERIALS	706	16,530	420	39.37	30,422	812	37.48	264,484	6,999	37.79	311,436	8,230	37.84
MAJOR ARTERIALS	404	33,845	818	41.37	49,326	1,406	35.09	516,758	13,156	39.28	599,930	15,380	39.01
RAMPS	0	0	0	0.00	0	0	0.00	0	0	0.00	0	0	0.00
FREEWAY	0	0	0	0.00	0	0	0.00	0	0	0.00	0	0	0.00
EXPRESSWAY	62	17,303	363	47.67	24,755	648	38.18	243,977	5,572	43.78	286,036	6,584	43.45
COLLECTORS	3483	10,611	309	34.35	17,269	529	32.65	161,923	4,728	34.25	189,803	5,566	34.10
CENTROIDS	263	5,542	222	25.00	9,098	364	25.00	83,341	3,334	25.00	97,982	3,919	25.00
BY AREA TYPE:													
CBD	313	2,748	86	32.09	4,192	143	29.35	39,947	1,289	30.99	46,886	1,518	30.89
URBAN	3,103	55,410	1,399	39.61	83,554	2,502	33.39	827,549	22,310	37.09	966,514	26,211	36.87
RURAL	1,238	20,115	424	47.42	34,002	747	45.50	319,415	6,840	46.70	373,532	8,011	46.63
CENTROID	262	5,542	222	25.00	9,097	364	25.00	83,332	3,333	25.00	97,971	3,919	25.00
GATEWAY	3	1,024	20	50.00	1,588	32	50.00	19,447	389	50.00	22,058	441	50.00
BY FACILITY AND AREA TYPE													
SYSTEM RAMPS / CBD	0	0	0	0.00	0	0	0.00	0	0	0.00	0	0	0.00
MINOR ART / CBD	5	54	2	29.87	73	2	29.69	739	25	29.92	866	29	29.90
MAJOR ART / CBD	57	2,341	70	33.66	3,410	111	30.75	33,273	1,022	32.56	39,023	1,202	32.46
RAMPS / CBD	0	0	0	0.00	0	0	0.00	0	0	0.00	0	0	0.00
FREEWAY / CBD	0	0	0	0.00	0	0	0.00	0	0	0.00	0	0	0.00
EXPRESSWAY / CBD	0	0	0	0.00	0	0	0.00	0	0	0.00	0	0	0.00
COLLECTOR / CBD	251	352	14	24.72	709	29	24.05	5,935	243	24.47	6,997	286	24.44
SYS RAMPS / URBAN	0	0	0	0.00	0	0	0.00	0	0	0.00	0	0	0.00
MINOR ART / URBAN	317	7,651	222	34.49	12,721	414	30.72	116,302	3,678	31.62	136,675	4,314	31.68
MAJOR ART / URBAN	280	23,436	587	39.92	34,338	1,063	32.31	358,653	9,632	37.24	416,427	11,282	36.91
RAMPS / URBAN	0	0	0	0.00	0	0	0.00	0	0	0.00	0	0	0.00
FREEWAY / URBAN	0	0	0	0.00	0	0	0.00	0	0	0.00	0	0	0.00

Douglas County/Carson City Regional Travel Demand Model

Table 7-10: Vehicle Miles Traveled and Vehicle Hours Traveled by Time Period—Douglas County (2014)

2014 VALIDATION		DOUGLAS COUNTY JURISDICTIONS											
GROUPING	NUM LINKS	AMPEAK			PMPEAK			OFFPEAK			DAILY		
		VMT	VHT	AVG SPEED	VMT	VHT	AVG SPEED	VMT	VHT	AVG SPEED	VMT	VHT	AVG SPEED
EXPRESSWAY / URBAN	43	14,740	313	47.11	21,004	554	37.89	207,092	4,787	43.26	242,835	5,654	42.95
COLLECTOR / URBAN	2,462	9,583	277	34.56	15,490	471	32.88	145,493	4,212	34.54	170,566	4,961	34.38
SYS RAMPS / RURAL	0	0	0	0.00	0	0	0.00	0	0	0.00	0	0	0.00
MINOR ART / RURAL	384	8,825	196	44.96	17,628	395	44.61	147,443	3,295	44.74	173,896	3,887	44.74
MAJOR ART / RURAL	67	8,068	161	49.99	11,579	232	49.90	124,832	2,502	49.89	144,479	2,896	49.90
RAMPS / RURAL	0	0	0	0.00	0	0	0.00	0	0	0.00	0	0	0.00
FREEWAY / RURAL	0	0	0	0.00	0	0	0.00	0	0	0.00	0	0	0.00
EXPRESSWAY / RURAL	19	2,564	50	51.18	3,751	94	39.88	36,885	786	46.95	43,200	930	46.47
COLLECTOR / RURAL	768	659	16	40.00	1,044	26	40.00	10,254	256	40.00	11,957	299	40.00
CENTROIDS	263	5,542	222	25.00	9,098	364	25.00	83,341	3,334	25.00	97,982	3,919	25.00
GATEWAY LINKS	3	1,024	20	50.00	1,588	32	50.00	19,447	389	50.00	22,058	441	50.00
JURISDICTIONS:													
JURISDICTION TOTALS	4,921	84,855	2,152	39.43	132,458	3,790	34.95	1,289,931	34,178	37.74	1,507,244	40,120	37.57

8. TRAVEL FORECAST MODEL APPLICATION

The Douglas County/Carson City Travel Demand Model may be utilized to simulate existing conditions and to forecast future conditions. In addition to estimating peak hour and daily traffic volumes, the model may be used to assess traffic level of service conditions.

Table 8-1 shows the level of service (LOS) thresholds that were assumed for the traffic operational performance on the different facilities. The results for the 2014 model validation forecast are shown in Table 8-2 for the different facility types and LOS thresholds. Figure 8-1 illustrates the level of service on various facilities for the 2014 model validation and application, while Figure 8-2 illustrates the existing daily volumes of traffic on those facilities.

Table 8-1: Level of Service Thresholds Used for LOS Calculations

ROADWAY TYPE	TOTAL DAILY VEHICLES IN BOTH DIRECTIONS (ADT)				
	A	B	C	D	E
6-lane freeway	67,500	78,750	90,000	101,250	112,500
4-lane freeway	45,000	52,500	60,000	67,500	75,000
2-lane freeway	30,000	35,000	40,000	45,000	50,000
6-lane expressway	43,200	50,400	57,600	64,800	72,000
4-lane expressway	28,800	33,600	38,400	43,200	48,000
2-lane expressway	19,200	22,400	25,600	28,800	32,000
6-lane major arterial	28,000	32,000	36,000	43,200	48,000
4-lane major arterial	18,000	20,000	24,000	28,800	32,000
2-lane major arterial	9,000	11,500	14,000	16,000	18,000
6-lane minor arterial	22,500	27,000	31,500	37,500	42,000
4-lane minor arterial	15,000	18,000	21,000	25,000	28,000
2-lane minor arterial	7,500	9,000	10,500	12,500	14,000
6-lane collector	22,500	27,000	31,500	37,500	42,000
4-lane collector	15,000	18,000	21,000	25,000	28,000
2-lane collector	7,500	9,000	10,500	12,500	14,000
6-lane ramp	12,150	14,175	16,200	18,225	20,250
4-lane ramp	8,100	9,450	10,800	12,150	13,500
2-lane ramp	5,400	6,300	7,200	8,100	9,000

Douglas County/Carson City Regional Travel Demand Model

Table 8-2: Summary of the Daily Level of Service on Various Facilities

GROUPING	ALL JURISDICTIONS/BOUNDARIES				CARSON CITY JURISDICTIONS				DOUGLAS COUNTY JURISDICTIONS			
	LINKS	VMT	VHT	AVG SPEED	LINKS	VMT	VHT	AVG SPEED	LINKS	VMT	VHT	AVG SPEED
ALL LINKS	7,868	2,598,273	67,794	38.33								
BY FACILITY TYPE AND LOS THRESHOLDS												
SYSTEM RAMPS / LOS A	0	0	0	0.00	0	0	0	0.00	0	0	0	0.00
MINOR ART / LOS A	1225	331,457	8,647	38.33	623	144,391	4,019	35.93	591	177,553	4,417	40.20
MAJOR ART / LOS A	430	407,541	9,074	44.91	201	92,719	2,206	42.02	229	314,823	6,868	45.84
RAMPS / LOS A	21	944	31	30.00	21	944	31	30.00	0	0	0	0.00
FREEWAY / LOS A	63	219,873	3,383	64.98	46	168,528	2,593	64.99	0	0	0	0.00
EXPRESSWAY / LOS A	0	0	0	0.00	0	0	0	0.00	0	0	0	0.00
COLLECTOR / LOS A	4695	232,490	6,690	34.75	1115	63,664	1,846	34.48	3453	163,792	4,718	34.72
CENTROIDS / LOS A	635	161,587	6,463	25.00	372	63,605	2,544	25.00	263	97,982	3,919	25.00
GATEWAY LINKS / LOS A	7	35,576	712	50.00	4	13,518	270	50.00	3	22,058	441	50.00
SYSTEM RAMPS / LOS B	0	0	0	0.00	0	0	0	0.00	0	0	0	0.00
MINOR ART / LOS B	50	26,851	781	34.39	32	16,560	482	34.35	18	10,291	299	34.46
MAJOR ART / LOS B	56	86,926	1,926	45.14	30	22,613	552	40.95	26	64,313	1,374	46.82
RAMPS / LOS B	2	103	3	30.00	2	103	3	30.00	0	0	0	0.00
FREEWAY / LOS B	0	0	0	0.00	0	0	0	0.00	0	0	0	0.00
EXPRESSWAY / LOS B	18	95,262	1,998	47.67	0	0	0	0.00	18	95,262	1,998	47.67
COLLECTOR / LOS B	16	18,511	573	32.28	5	10,871	323	33.64	11	7,640	250	30.52
CENTROIDS / LOS B	0	0	0	0.00	0	0	0	0.00	0	0	0	0.00
GATEWAY LINKS / LOS B	0	0	0	0.00	0	0	0	0.00	0	0	0	0.00
SYSTEM RAMPS / LOS C	0	0	0	0.00	0	0	0	0.00	0	0	0	0.00
MINOR ART / LOS C	44	81,290	1,917	42.41	2	985	29	33.92	42	80,305	1,888	42.54
MAJOR ART / LOS C	148	138,810	3,494	39.73	51	42,560	1,162	36.61	83	90,952	2,210	41.15
RAMPS / LOS C	2	239	8	30.00	2	239	8	30.00	0	0	0	0.00
FREEWAY / LOS C	0	0	0	0.00	0	0	0	0.00	0	0	0	0.00
EXPRESSWAY / LOS C	8	66,708	1,448	46.06	0	0	0	0.00	8	66,708	1,448	46.06
COLLECTOR / LOS C	19	18,370	597	30.75	0	0	0	0.00	19	18,370	597	30.75
CENTROIDS / LOS C	0	0	0	0.00	0	0	0	0.00	0	0	0	0.00
GATEWAY LINKS / LOS C	0	0	0	0.00	0	0	0	0.00	0	0	0	0.00
SYSTEM RAMPS / LOS D	0	0	0	0.00	0	0	0	0.00	0	0	0	0.00
MINOR ART / LOS D	50	40,114	1,276	31.44	19	11,047	357	30.92	31	29,067	919	31.65
MAJOR ART / LOS D	146	195,589	4,548	43.00	113	143,296	3,277	43.73	21	21,157	624	33.92
RAMPS / LOS D	0	0	0	0.00	0	0	0	0.00	0	0	0	0.00

Douglas County/Carson City Regional Travel Demand Model

Table 8-2: Summary of the Daily Level of Service on Various Facilities

GROUPING	ALL JURISDICTIONS/BOUNDARIES				CARSON CITY JURISDICTIONS				DOUGLAS COUNTY JURISDICTIONS			
	LINKS	VMT	VHT	AVG SPEED	LINKS	VMT	VHT	AVG SPEED	LINKS	VMT	VHT	AVG SPEED
FREEWAY / LOS D	0	0	0	0.00	0	0	0	0.00	0	0	0	0.00
EXPRESSWAY / LOS D	36	124,065	3,137	39.55	0	0	0	0.00	36	124,065	3,137	39.55
COLLECTOR / LOS D	1	1,961	72	27.33	1	1,961	72	27.33	0	0	0	0.00
CENTROIDS / LOS D	0	0	0	0.00	0	0	0	0.00	0	0	0	0.00
GATEWAY LINKS / LOS D	0	0	0	0.00	0	0	0	0.00	0	0	0	0.00
SYSTEM RAMPS / LOS E	0	0	0	0.00	0	0	0	0.00	0	0	0	0.00
MINOR ART / LOS E	7	4,599	170	26.98	0	0	0	0.00	7	4,599	170	26.98
MAJOR ART / LOS E	40	52,538	1,409	37.28	24	32,052	830	38.62	16	20,486	579	35.37
RAMPS / LOS E	0	0	0	0.00	0	0	0	0.00	0	0	0	0.00
FREEWAY / LOS E	0	0	0	0.00	0	0	0	0.00	0	0	0	0.00
EXPRESSWAY / LOS E	0	0	0	0.00	0	0	0	0.00	0	0	0	0.00
COLLECTOR / LOS E	0	0	0	0.00	0	0	0	0.00	0	0	0	0.00
CENTROIDS / LOS E	0	0	0	0.00	0	0	0	0.00	0	0	0	0.00
GATEWAY LINKS / LOS E	0	0	0	0.00	0	0	0	0.00	0	0	0	0.00
SYSTEM RAMPS / LOS F	0	0	0	0.00	0	0	0	0.00	0	0	0	0.00
MINOR ART / LOS F	17	9,622	538	17.88	0	0	0	0.00	17	9,622	538	17.88
MAJOR ART / LOS F	121	244,006	8,775	27.81	92	155,807	5,049	30.86	29	88,198	3,726	23.67
RAMPS / LOS F	11	3,243	120	26.92	11	3,243	120	26.92	0	0	0	0.00
FREEWAY / LOS F	0	0	0	0.00	0	0	0	0.00	0	0	0	0.00
EXPRESSWAY / LOS F	0	0	0	0.00	0	0	0	0.00	0	0	0	0.00
COLLECTOR / LOS F	0	0	0	0.00	0	0	0	0.00	0	0	0	0.00
CENTROIDS / LOS F	0	0	0	0.00	0	0	0	0.00	0	0	0	0.00
GATEWAY LINKS / LOS F	0	0	0	0.00	0	0	0	0.00	0	0	0	0.00
SUMMARY TOTAL												
TOTAL - LOS A					2,382	547,368	13,511	40.51	4,539	776,208	20,363	38.12
TOTAL - LOS B					69	50,147	1,361	36.85	73	177,506	3,921	45.27
TOTAL - LOS C					55	43,784	1,199	36.50	152	256,336	6,144	41.72
TOTAL - LOS D					133	156,304	3,706	42.18	88	174,290	4,679	37.25
TOTAL - LOS E					24	32,052	830	38.62	23	25,085	750	33.46
TOTAL - LOS F					103	159,050	5,170	30.77	46	97,820	4,264	22.94

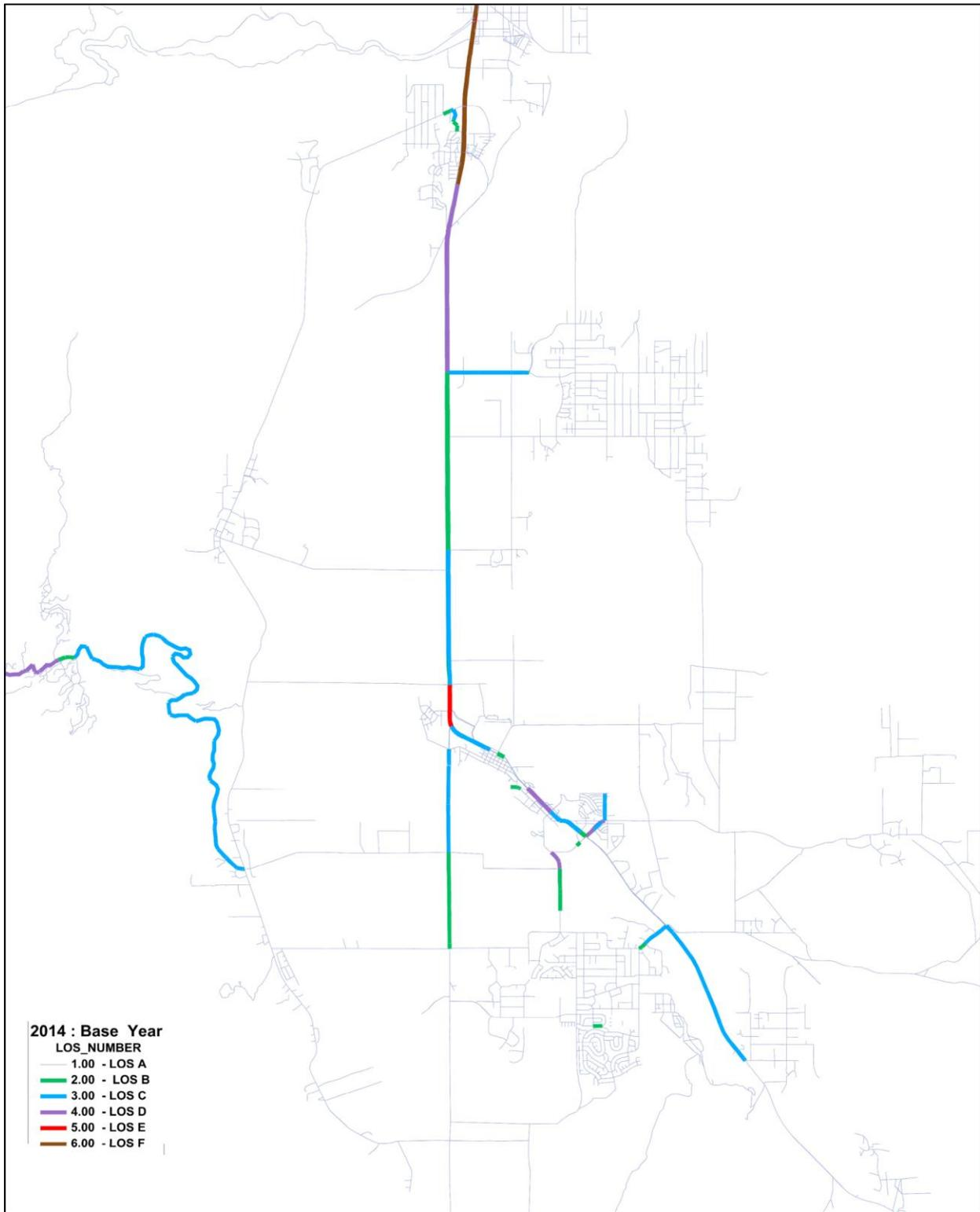

Figure 8-1: Daily Level of Service on Various Facilities

Douglas County/Carson City Regional Travel Demand Model

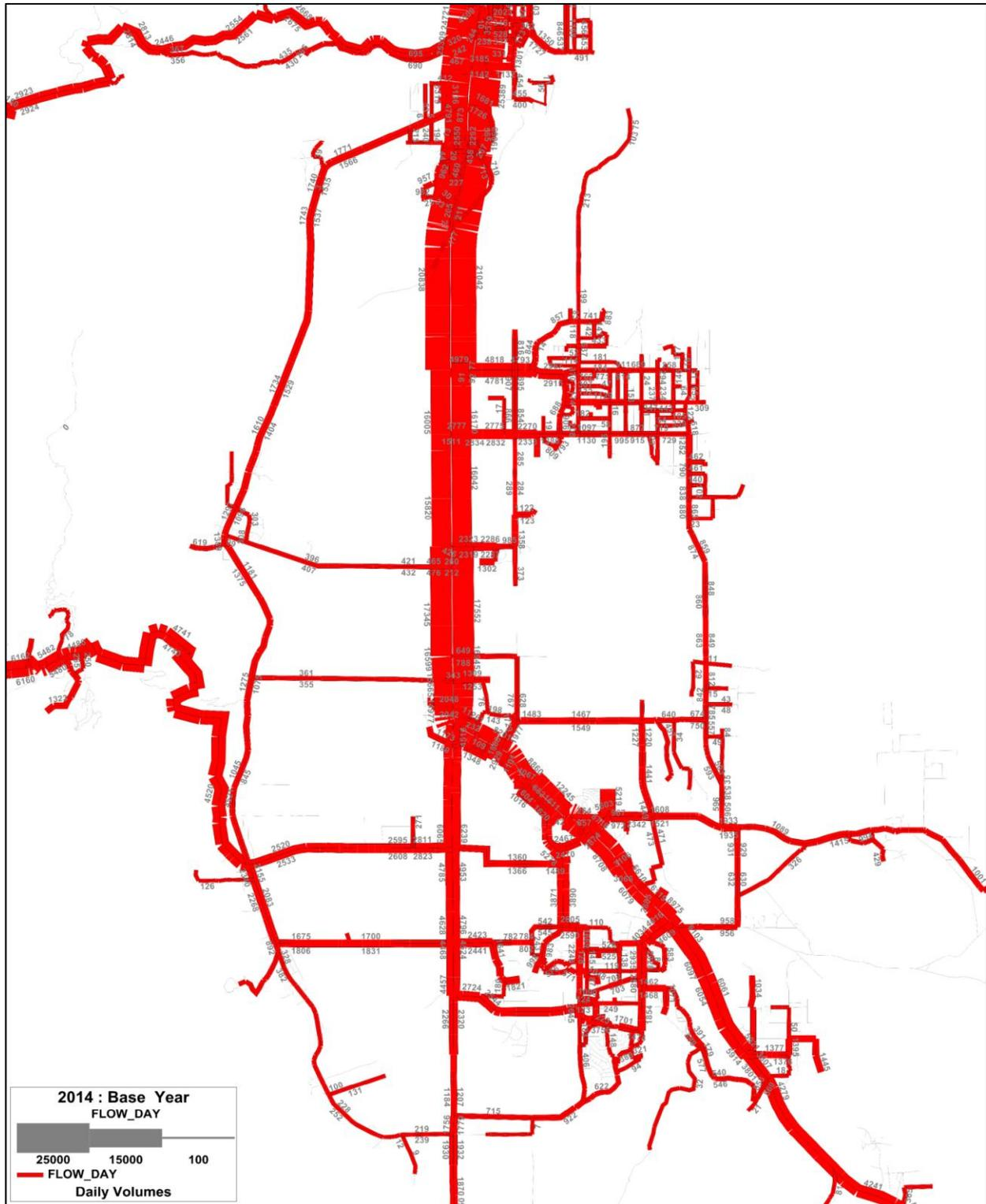

Figure 8-2: Year 2014 Existing Daily Traffic Volumes

9. FUTURE FORECASTS

Historic growth projection rates were used to produce future traffic forecasts for years 2025 and 2040. Table 9-1, below, presents land use data for year 2025, while Table 9-2 presents land use data for year 2040. Future condition levels of service and daily traffic volumes for two scenarios are illustrated on Figures 9-1 through 9-3 (year 2025) and Figures 9-4 through 9-6 (year 2040).

Table 9-1: Douglas County/Carson City Historic Growth Rates for 2025

JURISDICTION	ID	POP	DU	OCC DU	TOT EMP	HOTEL	OFFICE	INDUS
Carson City	1	57,660	24,603	22,402	32,177	186	11,813	4,684
Douglas County	2	57,214	28,096	23,791	24,608	3,525	5,675	4,588
Total		114,874	52,699	46,193	56,785	3,711	17,488	9,272

JURISDICTION	ID	RETAIL	NON-RETAIL	ELEM AND MIDDLE SCHOOL	HIGH SCHOOL	COLLEGE
Carson City	1	6,445	9,049	5,969	2,698	3,303
Douglas County	2	5,848	4,971	6,271	2,176	859
Total		12,294	14,020	12,240	4,874	4,162

Table 9-2: Douglas County/Carson City Historic Growth Rates for 2040

JURISDICTION	ID	POP	DU	OCC DU	TOT EMP	HOTEL	OFFICE	INDUS
Carson City	1	62,000	26,455	24,088	35,820	186	12,937	4,684
Douglas County	2	70,376	33,607	29,128	30,812	3,834	7,880	5,866
Total		132,376	60,062	53,217	66,633	4,020	20,817	10,550

JURISDICTION	ID	RETAIL	NON-RETAIL	ELEM AND MIDDLE SCHOOL	HIGH SCHOOL	COLLEGE
Carson City	1	7,841	10,173	6,418	2,901	3,551
Douglas County	2	8,028	5,204	7,714	2,677	1,057
Total		15,869	15,377	14,132	5,578	4,608

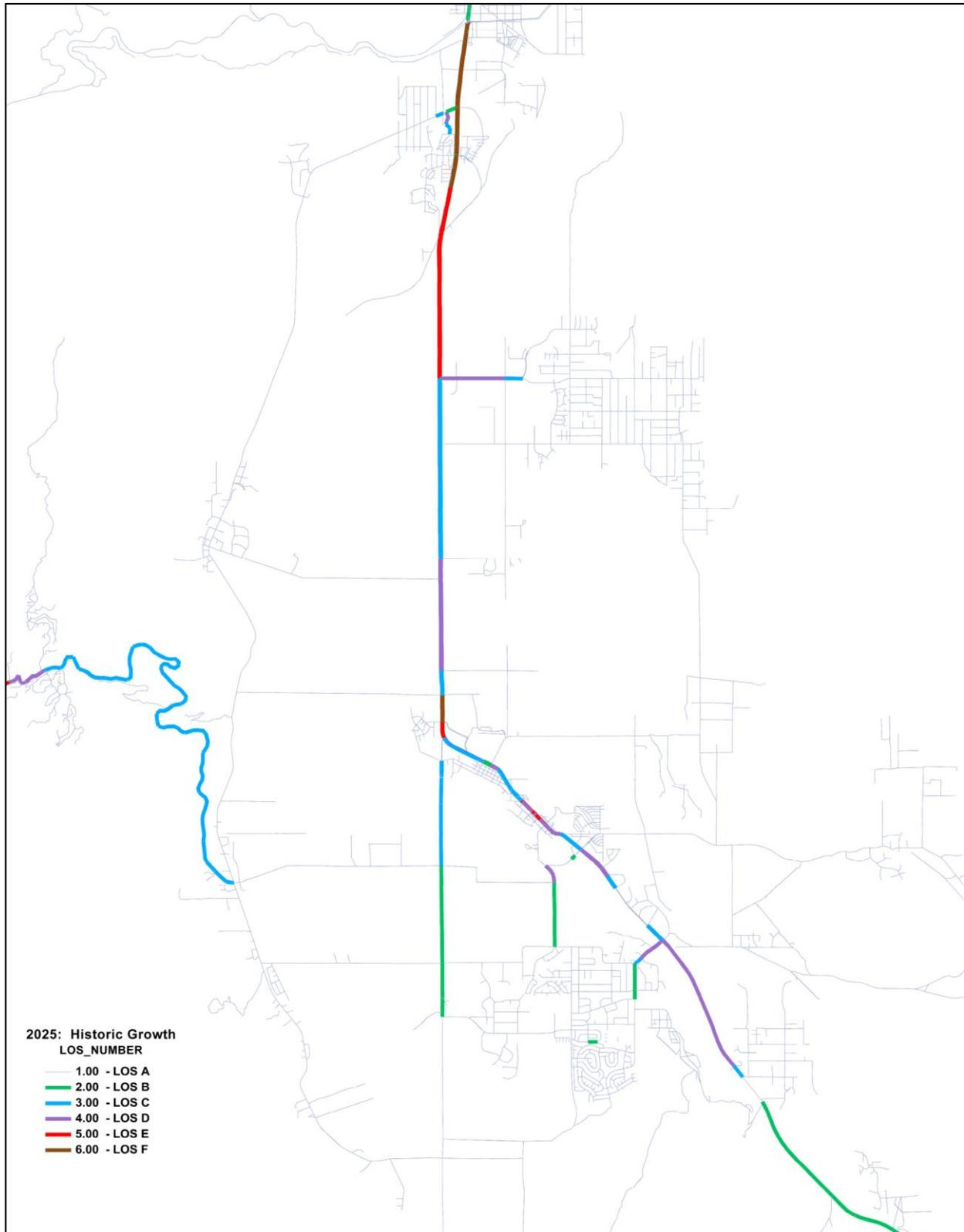

Figure 9-1: Year 2025 Level of Service on the Existing Roadway Network plus Vista Grande Extension

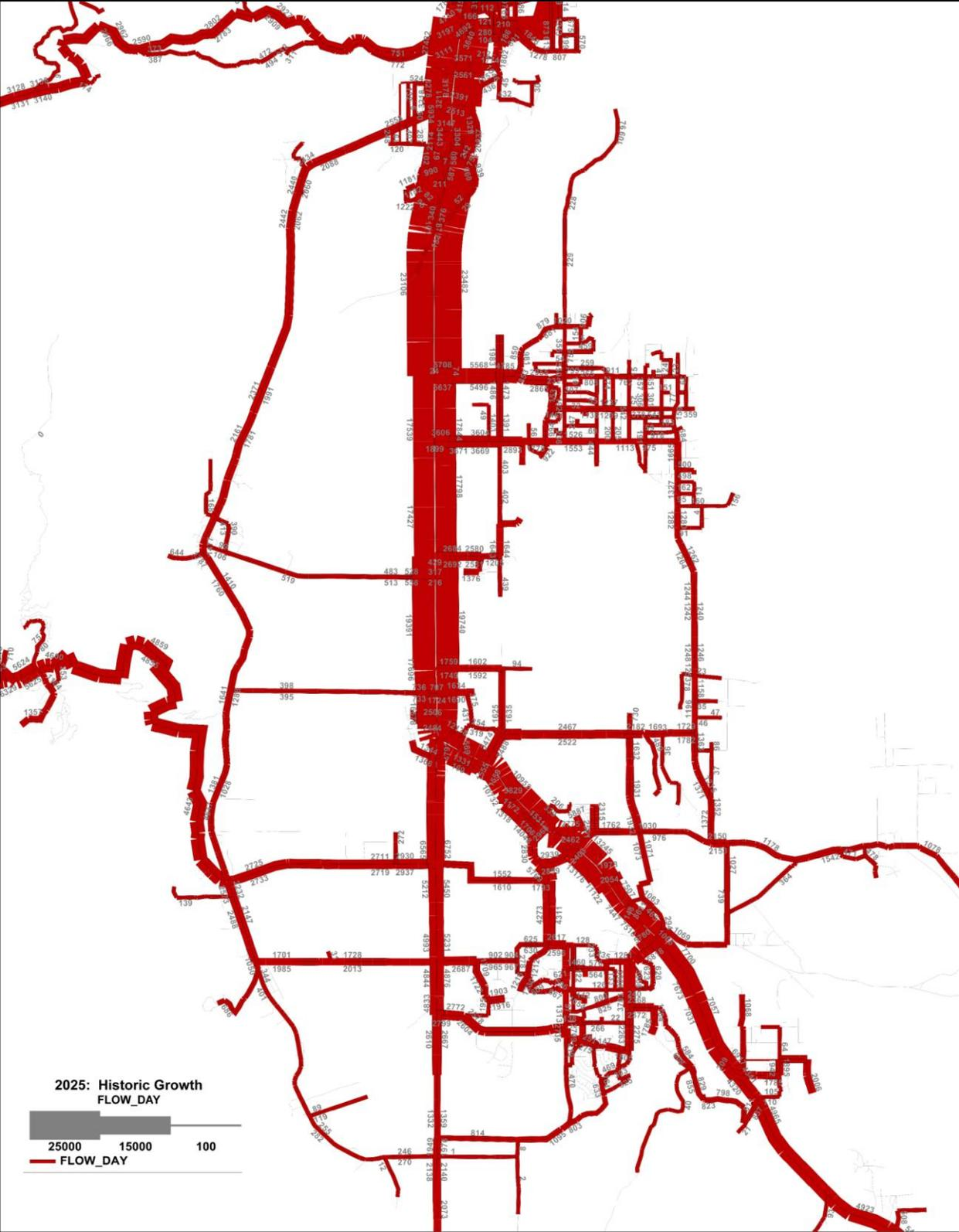

Figure 9-2: Year 2025 Traffic Volumes on the Existing Roadway Network plus Vista Grande Extension

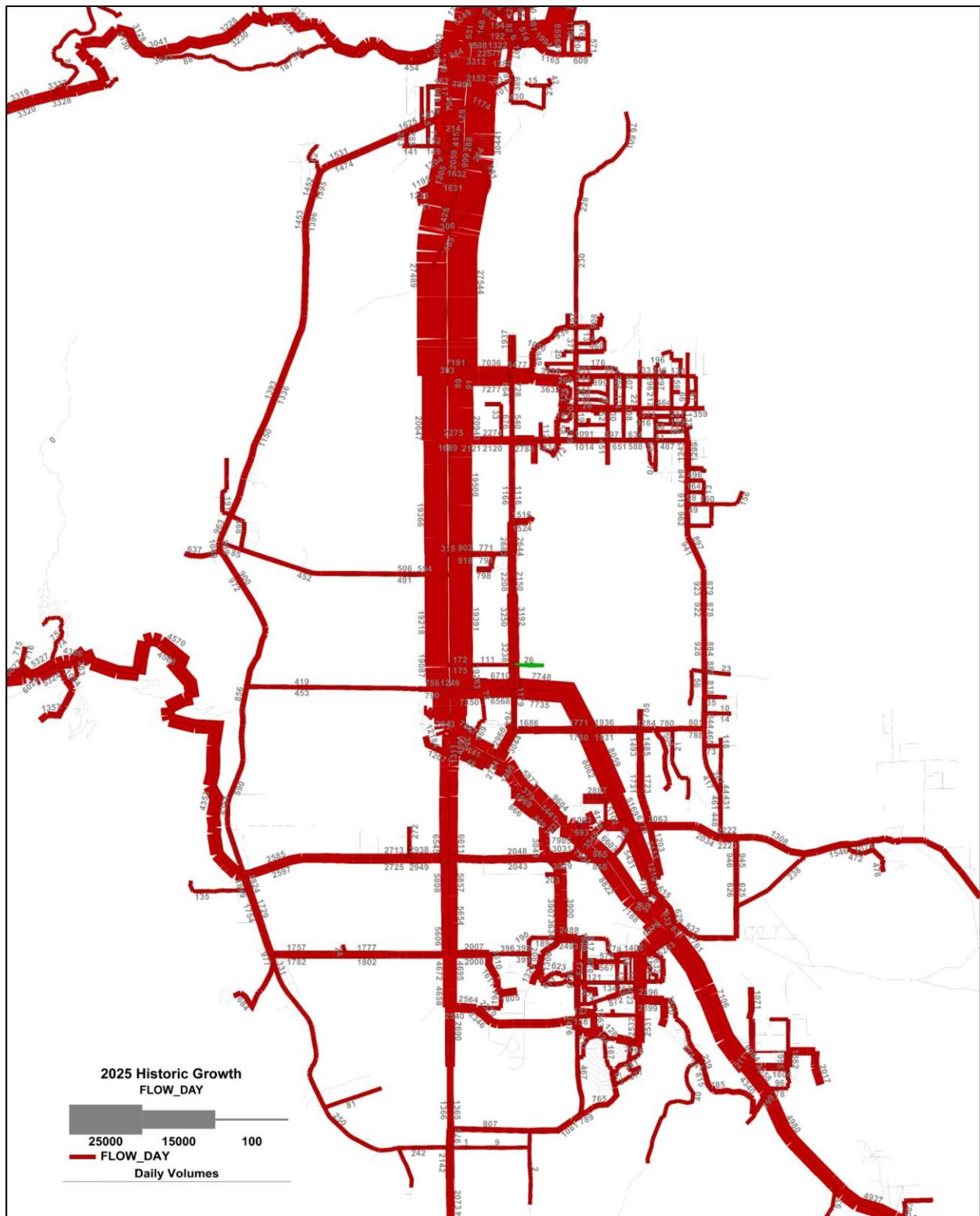

Figure 9-3: Year 2025 Traffic Volumes on the Existing Roadway Network plus Mid-term Projects— Vista Grande Extension, Waterloo Lane Extension and Heybourne Road from Johnson Lane to Stephanie Way

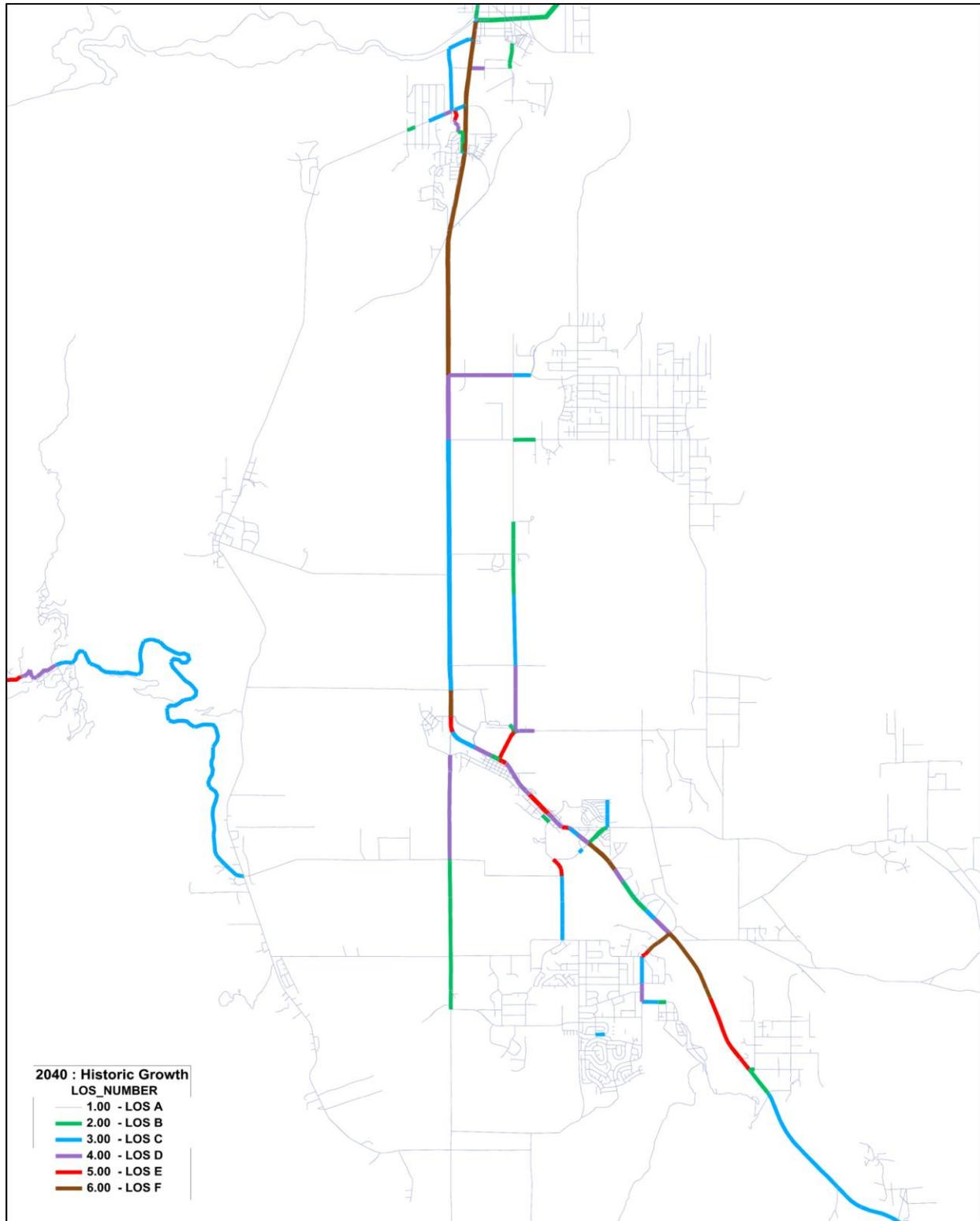

Figure 9-4: Year 2040 Level of Service on the Existing Roadway Network plus Vista Grande Extension and Heybourne Road from Buckeye Lane to Stephanie Way

Douglas County/Carson City Regional Travel Demand Model

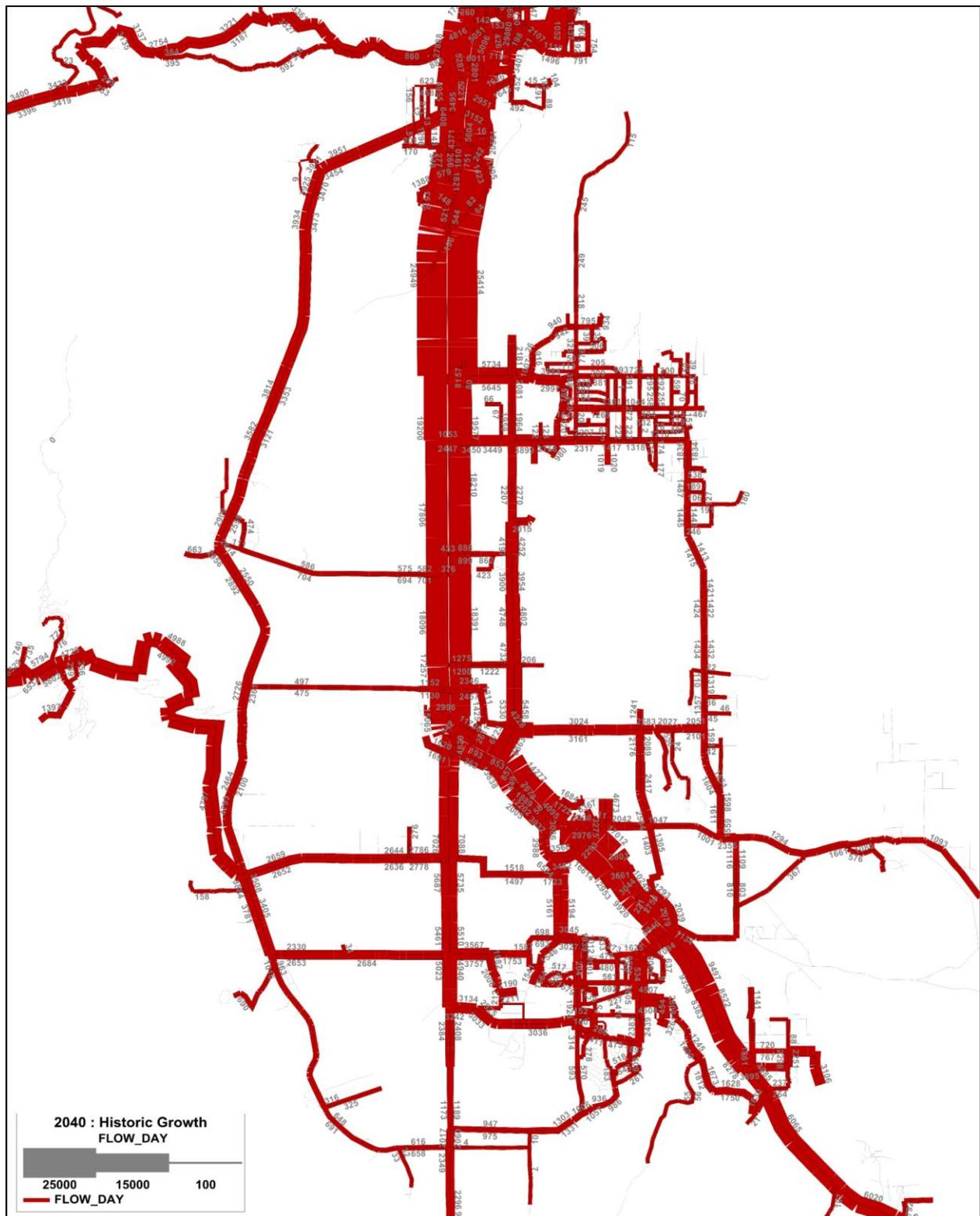

Figure 9-5: Year 2040 Traffic Volumes on the Existing Roadway Network plus Vista Grande Extension and Heybourne Road from Buckeye Road to Stephanie Way

Douglas County/Carson City Regional Travel Demand Model

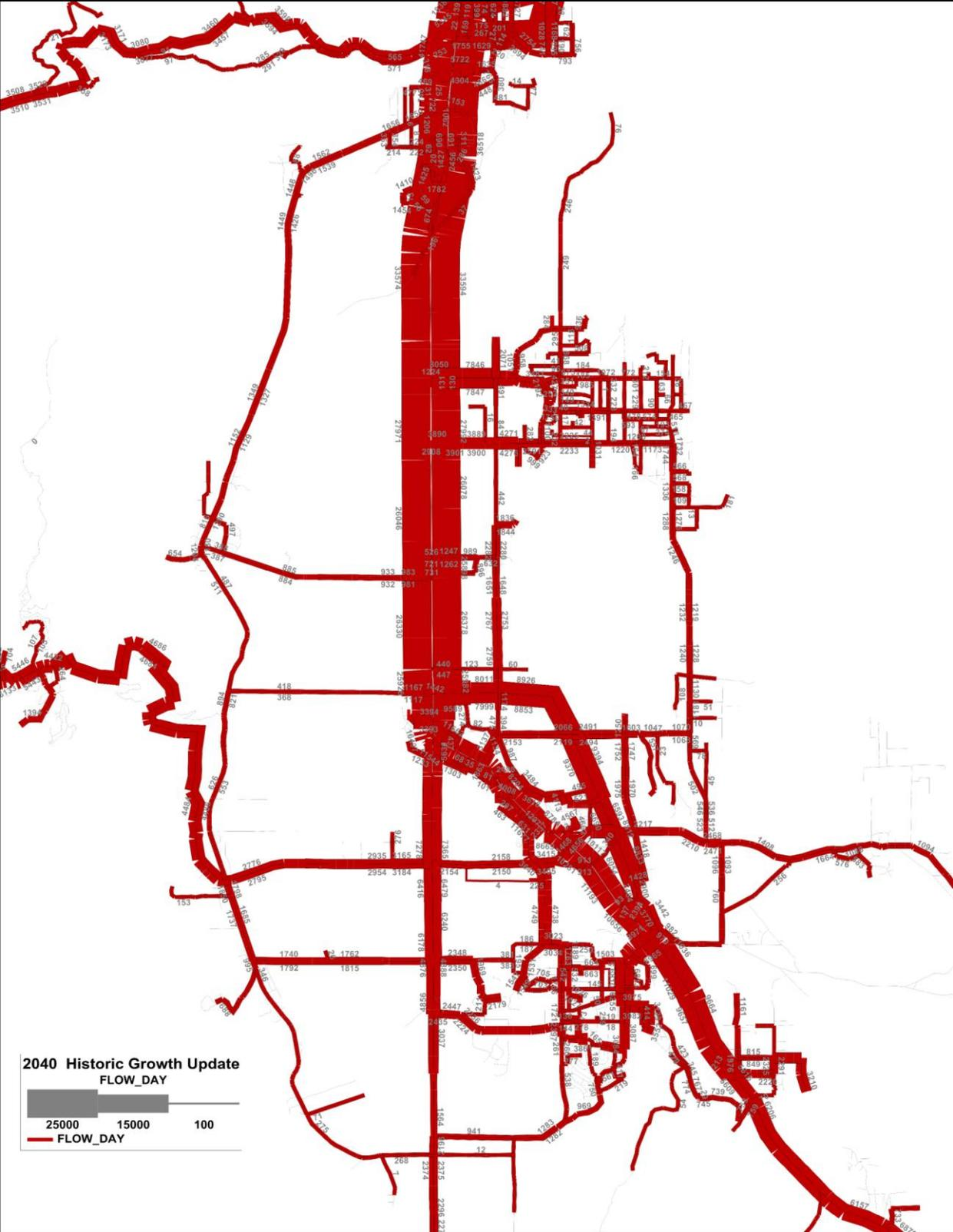

Figure 9-6: Year 2040 Traffic Volumes on the Existing Roadway Network plus Mid-term and Long-term Projects—Vista Grande Extension and Waterloo Lane Extension

APPENDICES

Douglas County/Carson City Regional Travel Demand Model

Appendix A: Input Files, Output Files and Parameters

This appendix describes the input and output files and parameters of the travel demand model.

Field_Name	Type	Index	Description
ID	Integer (4 bytes)	*	unique Link Identification Number
Length	Real (8 bytes)	*	Length of the link in miles
Dir	Integer (2 bytes)	*	one-way or 2-way links (Dir 0 = 2-way link, Dir 1 = 1-way link)
NAME	Character	*	Street Name
FTYPE_NUM	Integer (4 bytes)	*	Integer form of the Functional Class of a link
FTYPE_NAME	Character	*	Type of Functional Class
ATYPE_NUM	Integer (4 bytes)	*	Integer form for Area Type
ATYPE_NAME	Character	*	Description of Area Type (i.e. suburban, rural, etc.)
AB_LANES	Real (8 bytes)	*	Number of Lanes on AB Direction of Link
BA_LANES	Real (8 bytes)	*	Number of Lanes on BA Direction of Link
UNIT	Integer (4 bytes)	*	Must have a Value of 1
DAY_LANE_CAP	Integer (4 bytes)		Daily Capacity per Lane
HOUR_LANE_CAP	Integer (4 bytes)		Hourly Lane Capacity
AB_SPEED	Real (8 bytes)		Free-flow Speed on AB Direction of Link (mi/hr)
BA_SPEED	Real (8 bytes)		Free-flow Speed on BA Direction of Link (mi/hr)
ALPHA	Real (8 bytes)		BPR Coefficient
BETA	Real (8 bytes)		BPR Exponent
ALT_BETA	Real (8 bytes)		Alternative BPR Coefficient for a link
ALT_CAP	Real (8 bytes)		Alternative Capacity for a link
ALT_SPEED	Real (8 bytes)		Alternative Speed for a link
AB_TIME	Real (8 bytes)		Free Flow Travel Time in AB Direction of Link (computed as Length/AB_SPEED * 60)
BA_TIME	Real (8 bytes)		Free Flow Travel Time in BA Direction of Link (computed as Length/BA_SPEED * 60)
AB_TIME_PK	Real (8 bytes)		For First Iteration =*Time, else time is AMPEAK
BA_TIME_PK	Real (8 bytes)		For First Iteration =*Time, else time is AMPEAK
AB_TIME_OPK	Real (8 bytes)		For First Iteration =*Time, else time is OFFPEAK
BA_TIME_OPK	Real (8 bytes)		For First Iteration =*Time, else time is OFFPEAK
AB_TIME_AVG	Real (8 bytes)		For First Iteration =*Time, else Weighted Average of (AMPEAK, PMPEAK & OFFPEAK)
BA_TIME_AVG	Real (8 bytes)		For First Iteration =*Time, else Weighted Average of (AMPEAK, PMPEAK & OFFPEAK)
AB_HR_CAP	Integer (4 bytes)		One Hour Link Capacity
BA_HR_CAP	Integer (4 bytes)		One Hour Link Capacity
AB_10HR_CAP	Integer (4 bytes)		Offpeak Capacity is equal to 10* Hour Link Capacity
BA_10HR_CAP	Integer (4 bytes)		Offpeak Capacity is equal to 10* Hour Link Capacity
AB_DAY_CAP	Integer (4 bytes)		Daily Link Capacity
BA_DAY_CAP	Integer (4 bytes)		Daily Link Capacity
AB_COUNT_AMPeak	Integer (4 bytes)	**	am peak hour Counts
BA_COUNT_AMPeak	Integer (4 bytes)	**	am peak hour Counts
AB_COUNT_PMPeak	Integer (4 bytes)	**	pm peak hour Counts
BA_COUNT_PMPeak	Integer (4 bytes)	**	pm peak hour Counts
AB_COUNT_OffPeak	Integer (4 bytes)	**	offpeak period Counts
BA_COUNT_OffPeak	Integer (4 bytes)	**	offpeak period Counts
AB_COUNT_Daily	Integer (4 bytes)	**	Daily Counts
BA_COUNT_Daily	Integer (4 bytes)	**	Daily Counts

Douglas County/Carson City Regional Travel Demand Model

Field Name	Type	Index	Description
NDOT_ID2014	Integer (4 bytes)		
STN_NUMBER	Character		
AB_NDOT_3DAY_AMPeak	Real (8 bytes)		
BA_NDOT_3DAY_AMPeak	Real (8 bytes)		
TOT_NDOT_3DAY_AMPeak	Real (8 bytes)		
AB_NDOT_3DAY_PMPeak	Real (8 bytes)		
BA_NDOT_3DAY_PMPeak	Real (8 bytes)		
TOT_NDOT_3DAY_PMPeak	Real (8 bytes)		
AB_NDOT_3DAY_OffPeak	Real (8 bytes)		
BA_NDOT_3DAY_OffPeak	Real (8 bytes)		
TOT_NDOT_3DAY_OffPeak	Real (8 bytes)		
AB_NDOT_3DAY_Daily	Real (8 bytes)		
BA_NDOT_3DAY_Daily	Real (8 bytes)		
TOT_NDOT_3DAY_Daily	Real (8 bytes)		
PD_DAILY	Integer (4 bytes)		
INCLUDECOUNT	Integer (4 bytes)	**	Used in Summary Calculations - 1 indicates link will be used for comparisons of count to Peak/offpeak hour traffic volumes
INCLUDEALLCOUNT	Integer (4 bytes)	**	Used in Summary Calculations - 1 indicates link will be used for comparisons of count to Daily traffic volumes
SCREENLINE	Integer (4 bytes)	**	Used in Summary Calculations - 1 indicates the link will be used for hourly count calculations
SCREENLINEALL	Integer (4 bytes)	**	Used in Summary Calculations - 1 indicates the link will be used for Daily count calculations
JURISDICTIONS	Integer (4 bytes)		Jurisdiction boundaries
KFACTOR_DISTRICTS	Integer (4 bytes)		kfactor districts based on links
CFCC	Character		
FID_COUNTY	Integer (4 bytes)		
COUNTY_NAME	Character		
STATE_NAME	Character		
STATE_FIPS	Character		
CNTY_FIPS	Character		
FIPS	Character		

Field names denoted with a “*” are required fields for the model. Field names denoted with a “**” are required only in the model option that compares count information with model flow results.

Speed-Capacity Lookup Table (speedcaptable_final.bin)

Field	Description
FTYPE_NUM	Functional Classification
ATYPE_NUM	Area Type Classification
R_Speed	Free Flow Speeds for cross classification
R_DAYCAP	Daily capacity per lane for cross classification
R_HOURCAP	Hourly capacity per lane for cross classification
R_ALPHAVALUE	BPR alpha value for cross classification
R_BETAVALUE	BPR Beta Value for cross classification

Turn Penalties Table (05_Turn_Prohib.bin)*

Field	Description
FROM_ID	From Link ID
TO_ID	To Link ID
PENALTY	Penalty Value, missing value denotes a prohibition

Douglas County/Carson City Regional Travel Demand Model

Demographics Table (2014_Landuse.bin)

Field	Description
TAZ	Zone Number
DISTRICT	District Number
POP	Population
DU	Dwelling Units
OCCDU	Occupied Dwelling Units
TOTEMP	Total Employment
HOTEL	Hotel Employment
OFFICE	Office Employment
INDUST	Industrial Employment
R_SHOP	Retail Shop Employment
C_SHOP	Commercial Shop Employment
OTHER_RET	Other Retail Employment
OTHER_NON	Non Retail Employment
RETAIL	Total Retail Employment
CASINO_SPGN	Casino Special Generator
F18	Elementary/Middle School Employment
F912	High School Enrollment
F13	Community College Employment
MED_INC	Median Income for the TAZ
JURIS_ID	Jurisdiction ID

Residential Trip Generation Table

Field	Description
ID	TAZ
HBWP_INC1	Home Based Work Income group 1 Productions
HBWA_INC1	Home Based Work Income group 1 Attractions
HBWP_INC2	Home Based Work Income group 2 Productions
HBWA_INC2	Home Based Work Income group 2 Attractions
HBWP_INC3	Home Based Work Income group 3 Productions
HBWA_INC3	Home Based Work Income group 3 Attractions
HBWP_INC4	Home Based Work Income group 4 Productions
HBWA_INC4	Home Based Work Income group 4 Attractions
HBSCHP	Home Based School Productions
HBSCHA	Home Based School Attractions
HBSHOPP	Home Based Shop Productions
HBSHOPA	Home Based Shop Attractions
HBOTHERP	Home Based Other Productions
HBOTHERA	Home Based Other Attractions
NONHBP	Non Home Based Productions
NONHBA	Non Home Based Attractions

Friction Factors Table (FrictionFactors.bin)

Field	Description	Function
TIME	Travel Time	
HBW	Home Based Work Friction Factors (By Income Group)	Gamma
HBSCH	Home Based School Friction Factors	Gamma
HBSHOP	Home Based Shop Friction Factors	Gamma
HBOTHER	Home Based Other Friction Factors	Table
NONHB	Non Home Based Friction Factors	Table

Douglas County/Carson City Regional Travel Demand Model

Time Period Flow Table (Flow_ampeak.MTX, Flow_pmpeak.MTX, etc.)

Field	Description
ID1	Link ID
AB_Flow	Volume Flow in AB direction
BA_Flow	Volume Flow in BA direction
TOT_Flow	Total Volume Flow in both directions
AB_Time	Congested travel time in AB direction
BA_Time	Congested travel time in BA direction
MAX_Time	Congested travel time in both directions
AB_voc	Volume/Capacity ratio in AB direction
BA_voc	Volume/Capacity ratio in BA direction
MAX_voc	Volume/Capacity ratio in both directions
AB_vmt	Vehicle miles of travel in AB direction
BA_vmt	Vehicle miles of travel in BA direction
TOT_vmt	Vehicle miles of travel in both directions
AB_vht	Vehicle hours of travel in AB direction
BA_vht	Vehicle hours of travel in BA direction
TOT_vht	Vehicle hours of travel in both directions
AB_speed	Congested Speed in AB direction
BA_speed	Congested Speed in BA direction
AB_Cold_Flow	Volume Flow in the first 505 seconds of travel in AB direction
BA_Cold_Flow	Volume Flow in the first 505 seconds of travel in BA direction
TOT_Cold_Flow	Total Cold Flow in both directions
AB_Cold_V_Dist_T	Cold Flow VMT in AB direction
BA_Cold_V_Dist_T	Cold Flow VMT in BA direction

Results Table (Summaryresults.bin)*Field is irrelevant or not created if count information is not present in the line geography and if the option to compare counts with flows is turned off.

Summary Results Table

Field	Description
ID1	Link IDs
AB_TIME_XXXXXX / BA_TIME_XXXXXX	Congested Link travel times by direction and time period
Total_TIME_XXXXX	Total Congested travel time by time period
AB_FLOW_XXXXX / BA_FLOW_XXXXX	Assigned Link flows by direction and time period
Total_FLOW_XXXXX	Total Assigned Link Flows by time period
AB_DAY_FLOW / BA _DAY_FLOW	Total Daily Flow by direction
TOT_DAY_FLOW	Total Daily Flow
AB_VOC_DAY / BA_VOC_DAY	Daily Volume -to-Capacity ration by direction
DAY_VMT	Total Daily VMT
AVG_DAY_SPEED	Daily Average speed
AB_VOC_XXXXX / BA_VOC_XXXXX	Volume -to-Capacity ration by direction and time period

XXXXX = Time period

Traffic Volume Results

Field
AB_FLOW_AMPK

Douglas County/Carson City Regional Travel Demand Model

BA_FLOW_AMPK
Total_FLOW_AMPK
AB_FLOW_PMPK
BA_FLOW_PMPK
Total_FLOW_PMPK
AB_FLOW_OFFPK
BA_FLOW_OFFPK
Total_FLOW_OFFPK
ABFLOW_DAY
BA_FLOW_DAY
Total_FLOW_DAY

*Table is only created if count information is present and if option to compare counts with flows is turned on.

Functional Class Results Table (FuncclassResults.bin)*

Field	Description
FTYPE_NUM	Functional classification
DAY_VMT	Total Daily Vehicle Miles of Travel
TOT_DAY_FLOW	Total Daily flow
[Avg AVG_DAY_SPEED]	Daily Average Speed

The following table describes each of the generic parameters assignment step in the model:

Parameter	Description
Assignment Type	1 = use User Equilibrium, 2 = use Stochastic User Equilibrium
Random Factor	If SUE is chosen from above, perturb link travels times by this percent, otherwise ignore
Calculate counts*	1 = If network has count information, calculate differences between flows and counts
Assignment iterations	Number of assignment iterations to use for each time period (must choose List radio button)

If you are running the model on a network that does not have count fields (i.e., a future year network), you must put in a “0” for this parameter. By default, the model runs the base year 2014 network which does have count fields and thus, the default for this parameter is “1.”

2014 Travel Demand Model Setup Files

	INPUT FILES	OUTPUT FILES
<i>Model Year Dir</i>	2005	Contained in Each Model Year Directory
Create network	2014\Inputs\2014_NETWORK_FINAL.dbd 2014\Inputs\14_Turn-Prohib.bin common\speedcaptible_final.bin common\Zone_layer_taz331.dbd	network.net
Trip Generation	2014\Inputs\2014_Landuse.bin common\hhsizelkup.dbf common\hhinclkup.dbf common\crossclasstriprates.mtx common\attractiontrirates.bin	demographics_dist.bin tripgen.bin
Network Skimming	common\addtime_331.mtx	sp_pk.mtx sp_opk.mtx
Trip Distribution	common\frictionfactors.bin	pa.mtx
	common\kfactors_taz331.MTX	tldtable.bin
Modal split	common\aaorates.mtx common\diurnalscalibrated_final.bin 2014\Inputs\14_Other.mtx common\TransitShare_taz331.mtx	aa_output.bin transit.mtx od_ampeak.mtx od_pmpeak.mtx od_offpeak.mtx day_od.mtx
Assignment	-	flow_ampeak.bin flow_pmpeak.bin flow_offpeak.bin summaryresults.bin funcclassresults.bin

Douglas County/Carson City Regional Travel Demand Model

Appendix B: 2014 Land Use Data

TAZ	DISTRICT	POP	DU	OCCDU	TOTEMP	HOTEL	OFFICE	INDUST	R_SHOP	C_SHOP	OTHER_RET	OTHER_NON	RETAIL	CASINO_SPGN	F18	F912	F13	MED_INC	JURIS_ID
1	3	0	0	0	0	0	0	0	0	0	0	0	0	0	0	0	0	0	2
2	3	0	0	0	0	0	0	0	0	0	0	0	0	0	0	0	0	0	2
3	3	0	0	0	0	0	0	0	0	0	0	0	0	0	0	0	0	0	2
4	3	0	0	0	0	0	0	0	0	0	0	0	0	0	0	0	0	0	2
5	3	0	0	0	0	0	0	0	0	0	0	0	0	0	0	0	0	0	2
6	3	0	0	0	0	0	0	0	0	0	0	0	0	0	0	0	0	0	2
7	3	0	0	0	0	0	0	0	0	0	0	0	0	0	0	0	0	0	2
8	1	0	0	0	39	0	0	33	6	0	0	0	6	39	0	0	0	120,711	1
9	1	0	0	0	0	0	0	0	0	0	0	0	0	0	0	0	0	119,561	1
10	1	225	99	102	0	0	0	0	0	0	0	0	0	0	0	0	0	143,836	1
11	1	2	1	1	0	0	0	0	0	0	0	0	0	0	0	0	0	143,711	1
12	1	0	0	0	0	0	0	0	0	0	0	0	0	0	0	0	0	143,711	1
13	1	418	173	180	24	3	11	0	0	0	0	10	0	21	0	0	0	109,423	1
14	1	0	0	0	1495	0	101	3	0	0	0	1391	0	1495	0	0	0	109,423	1
15	1	556	234	256	13	0	10	3	0	0	0	0	0	13	0	0	0	142,104	1
16	1	3	2	2	3	0	0	0	0	0	0	3	0	3	0	0	0	38,000	1
17	1	216	93	96	155	0	0	72	25	0	0	58	25	155	0	0	0	115,966	1
18	1	108	45	46	15	0	0	11	0	0	0	4	0	15	0	0	0	132,661	1
19	1	106	34	35	1512	0	37	1409	17	3	0	46	20	1512	0	0	0	126,961	1
20	1	124	49	53	0	0	0	0	0	0	0	0	0	0	0	0	0	131,961	1
21	1	0	0	0	66	0	0	18	3	0	0	45	3	66	0	0	0	135,711	1
22	1	0	0	0	816	0	602	207	1	3	0	3	4	816	0	0	0	133,336	1
23	1	216	79	83	1147	0	15	955	32	35	0	110	67	1147	0	0	0	45,400	1
24	1	71	31	32	6	0	0	3	0	0	0	3	0	6	0	0	0	38,333	1
25	1	101	42	43	0	0	0	0	0	0	0	0	0	0	0	0	0	37,000	1
26	1	13	9	10	80	25	0	0	55	0	0	0	55	55	0	0	0	145,211	1
27	1	799	302	350	161	0	13	0	62	48	0	38	110	161	0	0	0	39,421	1
28	1	194	86	92	0	0	0	0	0	0	0	0	0	0	0	0	0	40,421	1
29	1	646	286	302	0	0	0	0	0	0	0	0	0	0	0	0	0	35,421	1
30	1	411	208	222	15	0	3	3	0	0	0	9	0	15	0	0	0	44,500	1
31	1	37	14	14	0	0	0	0	0	0	0	0	0	0	0	0	0	41,000	1
32	1	61	32	36	36	0	0	26	3	0	0	7	3	36	0	0	0	49,500	1
33	1	138	47	50	0	0	0	0	0	0	0	0	0	0	0	0	0	52,500	1
34	1	0	0	0	81	0	56	0	0	25	0	0	25	81	0	0	0	52,500	1
35	1	0	0	0	824	0	550	62	3	15	0	194	18	824	0	0	0	51,500	1
36	1	1	1	2	446	0	0	0	102	0	0	344	102	446	0	0	0	51,500	1
37	1	66	18	19	0	0	0	0	0	0	0	0	0	0	0	0	0	51,500	1
38	1	80	31	32	11	0	1	7	3	0	0	0	3	11	0	0	0	131,741	1

Douglas County/Carson City Regional Travel Demand Model

TAZ	DISTRICT	POP	DU	OCCDU	TOTEMP	HOTEL	OFFICE	INDUST	R_SHOP	C_SHOP	OTHER_RET	OTHER_NON	RETAIL	CASINO_SPGN	F18	F912	F13	MED_INC	JURIS_ID
39	1	302	123	128	4	0	3	1	0	0	0	0	0	4	0	0	0	123,741	1
40	1	166	76	82	0	0	0	0	0	0	0	0	0	0	0	0	0	138,241	1
41	1	0	0	0	0	0	0	0	0	0	0	0	0	0	0	0	0	134,241	1
42	1	0	0	0	0	0	0	0	0	0	0	0	0	0	0	0	0	134,241	1
43	1	0	0	0	0	0	0	0	0	0	0	0	0	0	0	0	0	134,241	1
44	1	518	296	328	554	0	0	0	3	1	0	550	4	554	0	0	0	134,241	1
45	1	418	118	120	12	0	6	3	3	0	0	0	3	12	0	0	0	152,241	1
46	1	418	197	204	395	0	171	8	0	47	0	169	47	395	0	0	0	50,122	1
47	1	52	20	22	216	0	1	0	0	0	0	215	0	216	0	0	0	147,241	1
48	1	0	0	0	103	0	43	0	0	0	0	60	0	103	0	0	0	147,241	1
49	1	639	261	276	16	0	3	13	0	0	0	0	0	16	0	0	0	47,205	1
50	1	719	384	470	251	7	139	0	27	50	0	28	77	244	0	0	0	25,250	1
51	1	633	265	335	19	0	11	0	0	0	0	8	0	19	0	0	0	26,912	1
52	1	700	309	324	576	0	47	3	125	97	250	54	472	576	0	0	0	31,091	1
53	1	0	0	0	734	0	439	149	56	18	0	72	74	734	0	0	0	30,136	1
54	1	696	376	408	76	0	7	25	0	3	0	41	3	76	526	0	0	32,911	1
55	1	596	191	217	4	0	3	0	0	0	0	1	0	4	0	0	0	31,649	1
56	1	220	77	80	68	0	0	42	3	0	0	23	3	68	0	0	0	42,400	1
57	1	0	0	0	270	0	17	174	20	0	0	59	20	270	0	0	0	107,309	1
58	1	20	9	9	0	0	0	0	0	0	0	0	0	0	0	0	0	101,025	1
59	1	0	0	0	0	0	0	0	0	0	0	0	0	0	0	0	0	140,034	1
60	1	214	59	59	481	0	163	185	63	7	0	63	70	481	0	0	0	112,434	1
61	1	198	74	77	127	0	3	7	22	0	0	95	22	127	0	0	0	115,267	1
62	1	573	206	212	24	0	15	3	0	0	0	6	0	24	0	0	0	51,250	1
63	1	578	224	243	0	0	0	0	0	0	0	0	0	0	0	0	0	46,380	1
64	1	711	294	328	263	0	16	4	147	90	0	6	237	263	0	0	0	34,219	1
65	1	4	1	1	0	0	0	0	0	0	0	0	0	0	0	0	0	34,219	1
66	1	680	273	292	6	0	3	0	0	0	0	3	0	6	0	0	0	33,743	1
67	1	567	211	231	3	0	3	0	0	0	0	0	0	3	0	0	0	33,309	1
68	1	259	100	117	112	0	3	7	27	0	0	75	27	112	0	0	0	38,571	1
69	1	78	51	63	0	0	0	0	0	0	0	0	0	0	0	0	0	33,375	1
70	1	1340	594	745	193	0	13	10	0	0	0	170	0	193	1046	0	0	36,580	1
71	1	490	149	153	6	0	0	0	0	0	0	6	0	6	0	0	0	41,136	1
72	1	393	137	144	7	0	0	0	0	0	0	7	0	7	0	0	0	35,074	1
73	1	1572	516	539	9	0	0	6	0	0	0	3	0	9	0	0	0	45,330	1
74	1	126	42	43	3	0	3	0	0	0	0	0	0	3	0	0	0	40,303	1
75	1	511	251	260	35	0	7	3	0	0	0	25	0	35	0	0	0	38,982	1
76	1	110	76	87	9	3	3	0	3	0	0	0	3	6	0	0	0	36,309	1
77	1	240	110	129	474	0	386	15	45	15	0	13	60	474	0	0	0	25,361	1
78	1	923	325	373	242	0	36	99	44	35	0	28	79	242	0	0	0	53,136	1
79	1	336	97	104	0	0	0	0	0	0	0	0	0	0	0	0	0	30,912	1

Douglas County/Carson City Regional Travel Demand Model

TAZ	DISTRICT	POP	DU	OCCDU	TOTEMP	HOTEL	OFFICE	INDUST	R_SHOP	C_SHOP	OTHER_RET	OTHER_NON	RETAIL	CASINO_SPGN	F18	F912	F13	MED_INC	JURIS_ID
80	1	0	0	0	342	0	93	4	49	72	0	124	121	342	0	0	0	28,750	1
81	1	786	372	417	362	0	99	1	31	7	0	224	38	362	0	0	0	44,496	1
82	1	725	361	434	687	3	498	7	67	13	0	99	80	684	0	0	0	22,152	1
83	1	426	204	245	284	0	77	14	22	24	0	147	46	284	0	0	0	25,145	1
84	1	365	194	210	108	3	46	0	27	0	0	32	27	105	750	0	3151	41,023	1
85	1	213	93	97	9	0	6	3	0	0	0	0	0	9	0	0	0	38,762	1
86	1	0	0	0	593	0	453	7	98	10	0	25	108	593	0	0	0	20,125	1
87	1	83	59	91	39	7	22	0	0	0	0	10	0	32	0	0	0	27,625	1
88	1	0	0	0	70	15	3	0	20	25	0	7	45	55	0	0	0	20,875	1
89	1	0	0	0	115	0	70	25	7	0	0	13	7	115	0	0	0	25,333	1
90	1	162	80	97	167	7	44	0	28	35	0	53	63	160	0	0	0	35,093	1
91	1	134	59	71	308	0	56	10	0	15	0	227	15	308	0	0	0	32,174	1
92	1	37	30	31	47	0	19	3	3	0	0	22	3	47	0	0	0	28,500	1
93	1	54	33	35	54	0	3	1	0	0	0	50	0	54	0	0	0	33,000	1
94	1	469	215	228	13	0	3	4	3	0	0	3	3	13	0	0	0	53,307	1
95	1	62	31	33	97	0	3	3	0	0	0	91	0	97	0	0	0	41,739	1
96	1	329	153	163	13	0	3	0	0	0	0	10	0	13	0	0	0	45,739	1
97	1	60	25	29	0	0	0	0	0	0	0	0	0	0	0	0	0	157,241	1
98	1	278	113	117	10	0	7	0	0	0	0	3	0	10	0	0	0	160,158	1
99	1	40	12	13	9	0	0	6	0	0	0	3	0	9	0	0	0	159,491	1
100	1	117	66	70	9	0	3	0	0	0	0	6	0	9	0	0	0	166,241	1
101	1	280	113	121	0	0	0	0	0	0	0	0	0	0	0	0	0	105,009	1
102	1	127	45	46	0	0	0	0	0	0	0	0	0	0	0	0	0	139,408	1
103	1	62	30	33	3	0	3	0	0	0	0	0	0	3	0	0	0	168,741	1
104	1	335	152	159	6	0	0	3	0	0	0	3	0	6	0	0	0	154,901	1
105	1	6	3	3	15	0	0	0	0	0	0	15	0	15	0	0	0	29,355	1
106	1	382	175	188	14	0	1	7	0	0	0	6	0	14	624	0	0	31,288	1
107	1	165	92	107	260	0	248	1	0	0	0	11	0	260	0	0	0	42,339	1
108	1	369	170	181	1262	0	9	3	0	0	0	1250	0	1262	0	0	0	35,125	1
109	1	112	51	60	68	0	48	1	0	0	0	19	0	68	0	0	0	45,125	1
110	1	46	18	28	141	0	44	0	7	68	0	22	75	141	0	0	0	50,010	1
111	1	37	27	30	264	0	127	1	10	39	0	87	49	264	0	0	0	41,268	1
112	1	0	0	1	1373	0	1074	1	3	42	0	253	45	1373	0	0	0	39,750	1
113	1	0	0	0	633	0	633	0	0	0	0	0	0	633	0	0	0	50,650	1
114	1	215	153	177	417	3	388	14	0	3	0	9	3	414	0	0	0	43,019	1
115	1	2063	793	897	144	0	110	3	9	0	0	22	9	144	0	0	0	37,566	1
116	1	423	173	199	106	0	41	0	30	0	0	35	30	106	0	0	0	36,187	1
117	1	0	0	0	593	0	304	0	177	64	0	48	241	593	0	0	0	68,417	1
118	1	0	0	0	8	0	1	0	7	0	0	0	7	8	0	0	0	68,417	1
119	1	20	9	9	0	0	0	0	0	0	0	0	0	0	0	0	0	67,417	1
120	1	0	0	0	0	0	0	0	0	0	0	0	0	0	0	0	0	66,417	1

Douglas County/Carson City Regional Travel Demand Model

TAZ	DISTRICT	POP	DU	OCCDU	TOTEMP	HOTEL	OFFICE	INDUST	R_SHOP	C_SHOP	OTHER_RET	OTHER_NON	RETAIL	CASINO_SPGN	F18	F912	F13	MED_INC	JURIS_ID
121	1	926	395	473	126	0	7	44	68	0	0	7	68	126	0	0	0	41,736	1
122	1	830	293	346	177	3	22	60	12	25	0	55	37	174	0	0	0	30,781	1
123	1	508	149	155	1	0	0	1	0	0	0	0	0	1	0	0	0	37,448	1
124	1	2123	581	650	32	0	25	0	3	0	0	4	3	32	0	0	0	35,590	1
125	1	0	0	0	0	0	0	0	0	0	0	0	0	0	0	0	0	73,917	1
126	1	258	101	105	10	0	0	7	0	0	0	3	0	10	0	0	0	129,851	1
127	1	789	295	342	30	0	14	15	0	0	0	1	0	30	0	0	0	124,434	1
128	1	855	331	353	28	0	16	7	3	0	0	2	3	28	0	0	0	129,045	1
129	1	262	101	106	0	0	0	0	0	0	0	0	0	0	0	0	0	112,767	1
130	1	255	102	103	3	0	0	3	0	0	0	0	0	3	0	0	0	128,184	1
131	1	103	45	46	3	0	3	0	0	0	0	0	0	3	0	0	0	131,601	1
132	1	0	0	0	0	0	0	0	0	0	0	0	0	0	0	0	0	92,634	1
133	1	0	0	0	0	0	0	0	0	0	0	0	0	0	0	0	0	133,017	1
134	1	185	77	85	1	0	1	0	0	0	0	0	0	1	0	0	0	151,434	1
135	1	399	168	174	16	0	3	10	0	0	0	3	0	16	0	0	0	137,372	1
136	1	52	19	19	1	0	1	0	0	0	0	0	0	1	0	0	0	135,184	1
137	1	0	0	0	15	0	0	0	0	0	0	15	0	15	0	0	0	135,184	1
138	1	0	0	0	0	0	0	0	0	0	0	0	0	0	0	0	0	135,184	1
139	1	1293	0	0	457	0	454	0	0	0	0	3	0	457	0	0	0	72,417	1
140	1	0	0	0	235	0	0	221	7	0	0	7	7	235	0	0	0	30,342	1
141	1	87	36	38	12	0	1	11	0	0	0	0	0	12	0	0	0	119,034	1
142	1	0	0	0	0	0	0	0	0	0	0	0	0	0	0	0	0	70,417	1
143	1	20	11	12	94	0	73	0	21	0	0	0	21	94	0	0	0	69,417	1
144	1	328	152	166	269	0	27	168	14	7	0	53	21	269	0	0	0	71,417	1
145	1	232	130	135	21	0	12	3	3	0	0	3	3	21	0	0	0	37,842	1
146	1	892	408	467	0	0	0	0	0	0	0	0	0	0	0	0	0	22,800	1
147	1	626	304	323	3	0	0	0	0	0	0	3	0	3	0	2574	0	28,633	1
148	1	253	97	101	104	0	35	3	65	0	0	1	65	104	0	0	0	37,542	1
149	1	257	138	151	21	0	7	0	0	0	0	14	0	21	0	0	0	19,800	1
150	1	0	0	0	13	0	13	0	0	0	0	0	0	13	0	0	0	35,800	1
151	1	8	4	4	121	18	64	7	6	13	0	13	19	103	0	0	0	46,373	1
152	1	152	94	108	135	0	98	0	15	0	0	22	15	135	0	0	0	36,925	1
153	1	1162	542	588	18	0	4	7	3	0	0	4	3	18	0	0	0	44,615	1
154	1	118	78	83	433	7	166	22	110	90	0	38	200	426	0	0	0	43,599	1
155	1	93	40	40	0	0	0	0	0	0	0	0	0	0	0	0	0	31,022	1
156	1	0	0	0	0	0	0	0	0	0	0	0	0	0	0	0	0	30,855	1
157	1	0	0	0	79	0	0	15	58	0	0	6	58	79	0	0	0	31,855	1
158	1	9	6	7	108	0	37	10	17	37	0	7	54	108	0	0	0	51,099	1
159	1	361	218	231	259	0	36	3	81	50	0	89	131	259	0	0	0	35,427	1
160	1	0	0	0	1480	0	1199	1	205	54	0	21	259	1480	0	0	0	46,175	1
161	1	0	0	0	101	0	19	0	0	75	0	7	75	101	0	0	0	42,800	1

Douglas County/Carson City Regional Travel Demand Model

TAZ	DISTRICT	POP	DU	OCCDU	TOTEMP	HOTEL	OFFICE	INDUST	R_SHOP	C_SHOP	OTHER_RET	OTHER_NON	RETAIL	CASINO_SPGN	F18	F912	F13	MED_INC	JURIS_ID
162	1	452	195	207	300	0	137	67	3	0	0	93	3	300	655	0	0	30,300	1
163	1	167	62	66	214	0	117	14	3	0	0	80	3	214	0	0	0	41,732	1
164	1	0	0	5	0	0	0	0	0	0	0	0	0	0	0	0	0	73,299	1
165	1	108	38	44	3	0	0	3	0	0	0	0	0	3	0	0	0	55,453	1
166	1	206	69	75	7	0	0	0	0	0	0	7	0	7	0	0	0	37,522	1
167	1	13	5	5	98	0	0	15	41	7	0	35	48	98	0	0	0	46,855	1
168	1	0	0	0	229	0	28	18	170	0	0	13	170	229	0	0	0	37,655	1
169	1	0	0	0	500	35	0	0	62	50	0	353	112	465	0	0	0	48,605	1
170	1	1	1	1	86	0	14	0	25	15	0	32	40	86	0	0	0	54,230	1
171	1	17	8	10	0	0	0	0	0	0	0	0	0	0	0	0	0	54,522	1
172	1	283	110	116	112	22	62	0	3	25	0	0	28	90	0	0	0	31,854	1
173	1	788	300	314	19	0	0	7	0	0	0	12	0	19	0	0	0	46,154	1
174	1	686	246	255	1	0	0	0	0	0	0	1	0	1	0	0	0	52,259	1
175	1	1131	386	400	13	0	3	4	0	0	0	6	0	13	1220	0	0	62,425	1
176	1	52	21	24	0	0	0	0	0	0	0	0	0	0	0	0	0	121,534	1
177	1	698	234	241	13	0	3	3	0	0	0	7	0	13	46	0	0	75,342	1
178	1	832	319	330	12	0	0	9	3	0	0	0	3	12	0	0	0	45,484	1
179	1	812	399	416	4	0	3	0	1	0	0	0	1	4	0	0	0	46,166	1
180	1	1127	449	476	683	10	80	43	306	70	0	174	376	673	0	0	0	42,152	1
181	1	134	0	0	946	15	118	91	384	328	0	10	712	931	0	0	0	25,500	1
182	1	262	117	125	4	0	0	4	0	0	0	0	0	4	0	0	0	22,591	1
183	1	82	31	32	3	0	0	3	0	0	0	0	0	3	0	0	0	48,750	1
184	1	157	63	68	0	0	0	0	0	0	0	0	0	0	0	0	0	73,756	1
185	1	31	14	14	7	0	0	7	0	0	0	0	0	7	0	0	0	124,034	1
186	1	345	128	135	0	0	0	0	0	0	0	0	0	0	0	0	0	115,534	1
187	1	0	0	1	0	0	0	0	0	0	0	0	0	0	0	0	0	129,867	1
188	1	28	9	9	0	0	0	0	0	0	0	0	0	0	0	0	0	153,211	1
189	1	219	80	81	7	0	0	0	7	0	0	0	7	7	0	0	0	133,867	1
190	1	207	85	87	41	0	0	9	0	15	0	17	15	41	0	0	0	138,034	1
191	1	33	11	11	0	0	0	0	0	0	0	0	0	0	0	0	0	44,000	1
192	1	0	0	0	0	0	0	0	0	0	0	0	0	0	0	0	0	126,534	1
193	1	57	20	20	6	0	0	0	0	0	0	6	0	6	0	0	0	129,534	1
194	1	137	50	50	0	0	0	0	0	0	0	0	0	0	0	0	0	131,867	1
195	1	180	76	84	3	0	0	0	0	0	0	3	0	3	0	0	0	36,167	1
196	1	74	28	29	114	0	0	15	29	70	0	0	99	114	0	0	0	34,300	1
197	1	207	95	111	56	0	4	0	3	26	0	23	29	56	0	0	0	35,833	1
198	1	44	19	20	18	0	0	0	0	0	0	18	0	18	668	0	0	53,750	1
199	1	126	45	50	7	0	0	7	0	0	0	0	0	7	0	0	0	53,250	1
200	1	0	0	0	156	0	156	0	0	0	0	0	0	156	0	0	0	46,000	1
201	1	185	79	83	6	0	0	0	0	0	0	6	0	6	0	0	0	66,050	1
202	1	32	21	22	383	0	38	0	3	0	250	92	253	383	0	0	0	57,605	1

Douglas County/Carson City Regional Travel Demand Model

TAZ	DISTRICT	POP	DU	OCCDU	TOTEMP	HOTEL	OFFICE	INDUST	R_SHOP	C_SHOP	OTHER_RET	OTHER_NON	RETAIL	CASINO_SPGN	F18	F912	F13	MED_INC	JURIS_ID
203	2	15	7	12	0	0	0	0	0	0	0	0	0	0	0	0	0	129,660	2
204	1	270	96	104	40	0	0	40	0	0	0	0	0	40	0	0	0	63,900	1
205	1	56	9	30	90	0	75	0	0	0	0	15	0	90	0	0	0	59,947	1
206	1	1810	0	0	496	0	479	3	0	0	0	14	0	496	0	0	0	88,714	1
207	1	26	8	9	3	0	0	3	0	0	0	0	0	3	0	0	0	149,443	1
208	1	42	14	16	10	0	0	10	0	0	0	0	0	10	0	0	0	158,934	1
209	1	21	7	7	0	0	0	0	0	0	0	0	0	0	0	0	0	153,684	1
210	1	0	0	0	0	0	0	0	0	0	0	0	0	0	160	0	0	155,709	1
211	2	474	211	235	28	0	0	3	0	0	0	25	0	28	0	0	0	93,510	2
212	2	740	286	306	168	0	34	6	0	7	0	121	7	168	0	0	0	104,110	2
213	2	435	165	169	40	0	18	0	15	0	0	7	15	40	0	0	0	84,013	2
214	2	79	36	41	1414	0	36	0	741	229	350	58	1320	1414	220	232	0	119,482	2
215	2	689	270	291	16	0	6	3	7	0	0	0	7	16	0	0	0	135,280	2
216	2	296	117	122	23	0	4	16	3	0	0	0	3	23	0	0	0	166,106	2
217	2	128	52	55	1	0	1	0	0	0	0	0	0	1	0	0	0	230,583	2
218	2	1115	419	451	37	0	18	0	3	3	0	13	6	37	0	0	0	84,567	2
219	2	704	254	292	22	0	0	15	0	0	0	7	0	22	0	0	0	151,260	2
220	2	729	297	308	9	0	3	3	0	0	0	3	0	9	0	0	0	98,556	2
221	2	22	10	13	0	0	0	0	0	0	0	0	0	0	0	0	0	209,833	2
222	2	227	107	115	0	0	0	0	0	0	0	0	0	0	0	0	0	167,374	2
223	2	88	39	43	61	0	6	1	0	0	0	54	0	61	0	0	0	173,842	2
224	2	15	7	8	3	0	0	0	0	0	0	3	0	3	0	0	0	228,393	2
225	2	239	86	96	0	0	0	0	0	0	0	0	0	0	0	0	0	102,738	2
226	2	583	270	465	46	0	17	4	0	0	0	25	0	46	0	0	0	76,109	2
227	2	565	290	663	331	0	30	25	6	165	0	105	171	331	0	0	0	53,827	2
228	2	913	427	577	343	150	144	21	7	0	0	21	7	193	0	0	0	130,263	2
229	2	0	0	0	3534	2712	4	4	62	143	0	609	205	822	0	0	0	37,343	2
230	2	274	131	189	127	0	81	10	9	3	0	24	12	127	0	0	0	88,678	2
231	2	514	245	304	918	0	549	114	62	57	0	136	119	918	0	0	0	96,678	2
232	2	392	181	258	151	0	26	30	0	75	0	20	75	151	459	0	0	83,587	2
233	2	559	297	830	304	304	0	0	0	0	0	0	0	0	0	0	0	136,922	2
234	2	409	183	286	27	3	1	15	0	0	0	8	0	24	0	0	0	127,903	2
235	2	688	345	659	607	0	258	46	89	107	0	107	196	607	0	0	0	129,146	2
236	2	196	91	105	117	1	19	5	13	10	0	69	23	116	0	0	0	223,346	2
237	2	128	59	71	6	0	0	0	0	0	0	6	0	6	0	0	0	220,402	2
238	2	443	230	593	102	0	38	13	0	3	0	48	3	102	0	0	0	63,080	2
239	2	221	103	117	9	0	6	3	0	0	0	0	0	9	0	0	0	252,465	2
240	2	567	259	330	71	0	14	17	0	0	0	40	0	71	0	0	0	192,171	2
241	2	249	106	117	21	0	1	6	0	0	0	14	0	21	0	0	0	234,017	2
242	2	12	9	177	136	70	1	0	0	65	0	0	65	66	0	0	0	204,152	2
243	2	48	16	17	67	0	55	0	7	0	0	5	7	67	0	0	0	214,402	2

Douglas County/Carson City Regional Travel Demand Model

TAZ	DISTRICT	POP	DU	OCCDU	TOTEMP	HOTEL	OFFICE	INDUST	R_SHOP	C_SHOP	OTHER_RET	OTHER_NON	RETAIL	CASINO_SPGN	F18	F912	F13	MED_INC	JURIS_ID
244	2	844	364	399	145	15	1	0	0	3	0	126	3	130	0	1553	0	54,323	2
245	2	0	0	0	0	0	0	0	0	0	0	0	0	0	0	0	0	54,323	2
246	2	0	0	0	0	0	0	0	0	0	0	0	0	0	0	0	0	211,402	2
247	2	23	11	13	3	0	0	0	0	0	0	3	0	3	0	0	0	168,607	2
248	2	20	7	10	0	0	0	0	0	0	0	0	0	0	0	0	0	210,402	2
249	2	18	6	6	0	0	0	0	0	0	0	0	0	0	0	0	0	210,402	2
250	2	0	0	0	0	0	0	0	0	0	0	0	0	0	0	0	0	231,556	2
251	2	45	20	23	41	0	4	15	3	0	0	19	3	41	0	0	0	140,585	2
252	2	37	25	25	0	0	0	0	0	0	0	0	0	0	0	0	0	129,710	2
253	2	45	18	18	16	0	6	7	0	0	0	3	0	16	0	0	0	116,525	2
254	2	0	0	0	0	0	0	0	0	0	0	0	0	0	0	0	0	103,858	2
255	2	635	254	268	10	0	4	0	3	0	0	3	3	10	0	0	0	115,858	2
256	2	636	264	277	11	0	7	3	0	0	0	1	0	11	0	0	0	97,220	2
257	2	73	31	38	3	0	0	3	0	0	0	0	0	3	0	0	0	131,858	2
258	2	79	35	35	3	0	0	0	3	0	0	0	3	3	0	0	0	131,858	2
259	2	894	328	343	5	0	1	0	0	0	0	4	0	5	0	0	0	122,858	2
260	2	278	109	111	1	0	1	0	0	0	0	0	0	1	0	0	0	128,858	2
261	2	411	158	165	13	0	3	10	0	0	0	0	0	13	0	0	0	131,858	2
262	2	330	126	134	0	0	0	0	0	0	0	0	0	0	0	0	0	105,220	2
263	2	20	7	8	13	0	6	7	0	0	0	0	0	13	0	0	0	97,720	2
264	2	140	59	61	9	0	4	1	0	0	0	4	0	9	0	0	0	110,488	2
265	2	84	30	31	16	0	3	6	0	0	0	7	0	16	0	0	0	103,232	2
266	2	370	142	144	0	0	0	0	0	0	0	0	0	0	0	0	0	113,311	2
267	2	241	91	92	30	0	9	21	0	0	0	0	0	30	0	0	0	118,488	2
268	2	198	72	77	9	0	1	7	0	0	0	1	0	9	0	0	0	113,488	2
269	2	126	53	55	8	0	0	8	0	0	0	0	0	8	0	0	0	102,488	2
270	2	310	119	130	28	0	0	6	15	0	0	7	15	28	0	0	0	131,858	2
271	2	312	122	128	13	0	3	0	3	0	0	7	3	13	0	0	0	126,488	2
272	2	335	130	137	20	0	6	10	0	0	0	4	0	20	0	0	0	136,488	2
273	2	214	85	92	3	0	3	0	0	0	0	0	0	3	0	0	0	136,488	2
274	2	109	37	38	0	0	0	0	0	0	0	0	0	0	0	0	0	136,027	2
275	2	202	73	76	18	0	6	3	0	0	0	9	0	18	415	0	0	247,803	2
276	2	159	65	70	0	0	0	0	0	0	0	0	0	0	0	0	0	235,803	2
277	2	17	7	7	1	0	0	1	0	0	0	0	0	1	0	0	0	61,750	2
278	2	47	15	16	0	0	0	0	0	0	0	0	0	0	0	0	0	245,803	2
279	2	11	6	7	0	0	0	0	0	0	0	0	0	0	0	0	0	245,803	2
280	2	0	0	0	1	0	0	1	0	0	0	0	0	1	0	0	0	245,803	2
281	2	38	17	25	15	0	0	0	0	0	0	15	0	15	0	0	0	230,803	2
282	2	0	0	0	651	0	135	364	51	15	0	86	66	651	0	0	0	234,803	2
283	2	0	0	0	1446	0	132	1071	17	15	0	211	32	1446	0	0	0	225,803	2
284	2	2	1	2	35	0	0	0	0	0	0	35	0	35	0	0	0	225,803	2

Douglas County/Carson City Regional Travel Demand Model

TAZ	DISTRICT	POP	DU	OCCDU	TOTEMP	HOTEL	OFFICE	INDUST	R_SHOP	C_SHOP	OTHER_RET	OTHER_NON	RETAIL	CASINO_SPGN	F18	F912	F13	MED_INC	JURIS_ID
285	2	0	0	0	0	0	0	0	0	0	0	0	0	0	0	0	0	225,803	2
286	2	5	2	3	7	0	0	7	0	0	0	0	0	7	0	0	0	245,803	2
287	2	0	0	0	0	0	0	0	0	0	0	0	0	0	0	0	0	245,803	2
288	2	21	8	9	0	0	0	0	0	0	0	0	0	0	0	0	0	67,917	2
289	2	102	40	42	0	0	0	0	0	0	0	0	0	0	0	0	0	70,000	2
290	2	32	11	15	124	0	46	75	0	0	0	3	0	124	0	0	0	248,136	2
291	2	0	0	0	0	0	0	0	0	0	0	0	0	0	0	0	0	238,803	2
292	2	24	9	14	0	0	0	0	0	0	0	0	0	0	0	0	0	236,803	2
293	2	1107	512	542	391	0	89	28	55	50	0	169	105	391	467	0	0	229,794	2
294	2	13	5	7	0	0	0	0	0	0	0	0	0	0	0	0	0	280,803	2
295	2	2096	1049	1182	3249	18	1531	88	100	221	0	1291	321	3231	0	0	0	58,215	2
296	2	497	247	269	410	7	32	7	81	85	0	198	166	403	678	0	0	26,801	2
297	2	2350	939	1013	298	0	43	27	119	75	0	34	194	298	845	0	705	195,662	2
298	2	49	20	20	871	0	38	792	0	25	0	16	25	871	0	0	0	270,136	2
299	2	309	131	159	21	0	3	9	0	0	0	9	0	21	0	0	0	261,136	2
300	2	538	217	239	135	0	15	120	0	0	0	0	0	135	0	0	0	92,861	2
301	2	169	68	75	1	0	0	0	0	0	0	1	0	1	0	0	0	86,500	2
302	2	749	296	324	38	0	8	18	3	0	0	9	3	38	0	0	0	65,397	2
303	2	273	116	123	30	0	3	27	0	0	0	0	0	30	0	0	0	78,568	2
304	2	1735	675	734	1518	0	98	228	277	149	250	516	676	1518	0	0	0	69,807	2
305	2	6	3	3	41	0	0	1	7	0	0	33	7	41	0	0	0	98,750	2
306	2	232	98	117	40	0	9	6	0	0	0	25	0	40	0	0	0	41,996	2
307	2	188	73	80	29	0	0	7	0	0	0	22	0	29	0	0	0	216,490	2
308	2	13	6	9	7	0	6	0	0	0	0	1	0	7	0	0	0	249,652	2
309	2	121	57	65	8	0	5	3	0	0	0	0	0	8	0	0	0	248,652	2
310	2	333	155	176	23	0	13	10	0	0	0	0	0	23	0	0	0	278,637	2
311	2	492	203	224	29	0	10	3	0	0	0	16	0	29	0	0	0	270,180	2
312	2	6	4	4	15	0	0	0	15	0	0	0	15	15	0	0	0	263,402	2
313	2	366	195	213	78	0	3	10	7	21	0	37	28	78	0	0	0	197,765	2
314	2	1136	409	428	50	0	2	28	8	0	0	12	8	50	0	0	0	46,403	2
315	2	1365	515	557	92	0	3	43	15	13	0	18	28	92	0	0	0	49,025	2
316	2	2507	1031	1145	142	0	28	34	24	14	0	42	38	142	0	0	0	91,865	2
317	2	388	160	174	104	0	18	20	3	15	0	48	18	104	0	0	0	88,172	2
318	2	16	6	6	7	0	0	0	7	0	0	0	7	7	0	0	0	108,939	2
319	2	605	242	254	100	0	65	9	7	0	0	19	7	100	0	0	0	140,346	2
320	2	998	359	382	93	0	1	8	0	0	0	84	0	93	0	0	0	117,749	2
321	2	4313	1640	1721	35	0	7	9	3	0	0	16	3	35	0	0	0	110,504	2
322	2	39	20	24	7	0	7	0	0	0	0	0	0	7	0	0	0	289,902	2
323	2	14	7	7	3	0	3	0	0	0	0	0	0	3	0	0	0	231,490	2
324	2	0	0	1	0	0	0	0	0	0	0	0	0	0	606	0	0	173,896	2
325	2	133	70	78	14	0	7	0	0	0	0	7	0	14	0	0	0	133,939	2

Douglas County/Carson City Regional Travel Demand Model

TAZ	DISTRICT	POP	DU	OCCDU	TOTEMP	HOTEL	OFFICE	INDUST	R_SHOP	C_SHOP	OTHER_RET	OTHER_NON	RETAIL	CASINO_SPGN	F18	F912	F13	MED_INC	JURIS_ID
326	2	4	2	2	7	0	0	7	0	0	0	0	0	7	0	0	0	161,233	2
327	2	0	0	0	0	0	0	0	0	0	0	0	0	0	0	0	0	234,073	2
328	2	85	15	19	0	0	0	0	0	0	0	0	0	0	0	0	0	150,697	2
329	2	1258	476	530	81	0	5	44	0	0	0	32	0	81	0	0	0	120,920	2
330	2	322	143	169	129	0	0	0	85	25	0	19	110	129	494	0	0	33,833	2
331	2	1863	884	1107	228	3	150	18	18	0	0	39	18	225	960	0	0	38,385	2
TOTAL		102,079	40,984	47,116	49,737	3,469	15,089	8,274	5,185	3,459	1,100	13,161	9,744	46,268	10,839	4,359	3,856		

Douglas County/Carson City Regional Travel Demand Model

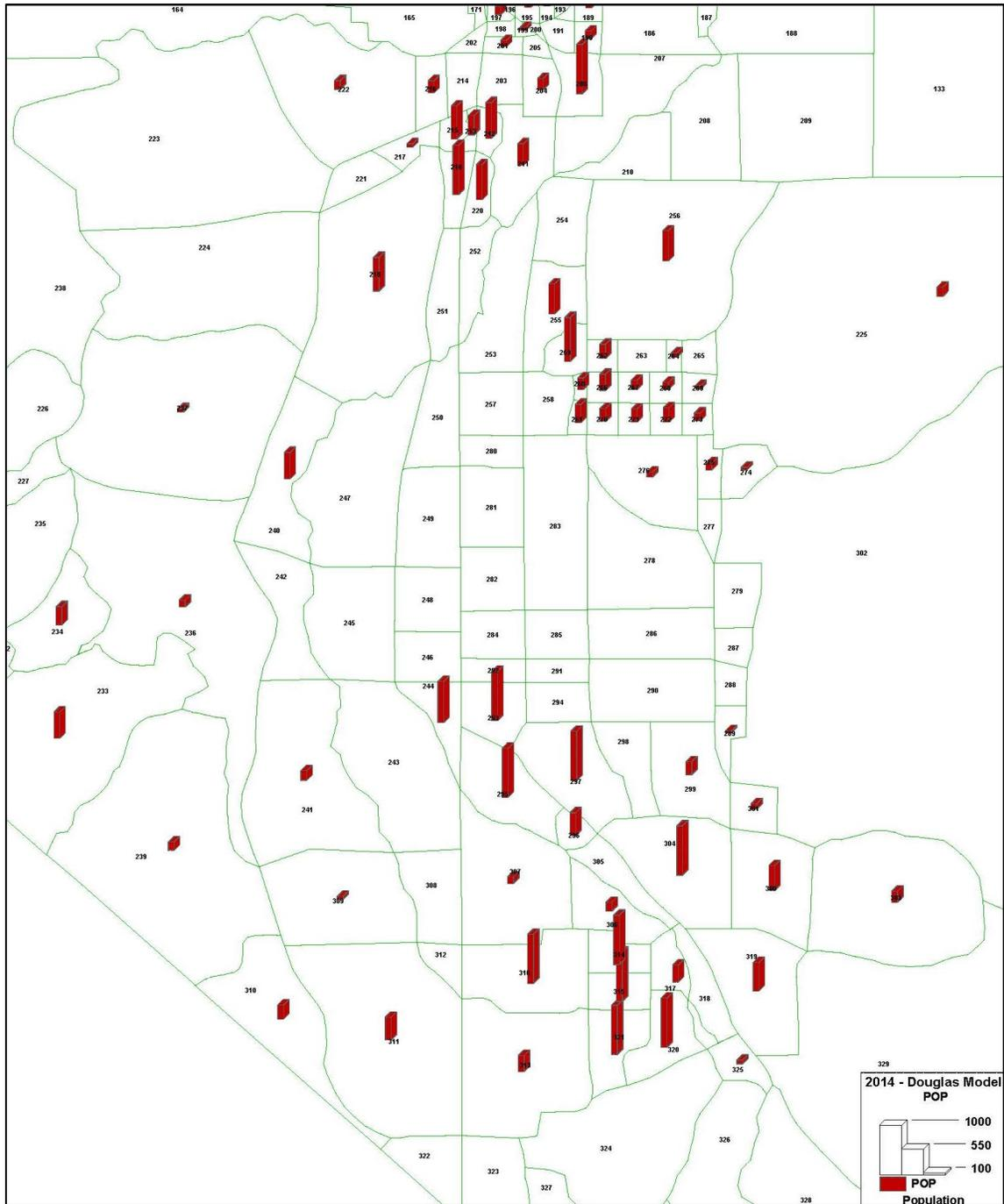

Douglas County/Carson City Regional Travel Demand Model

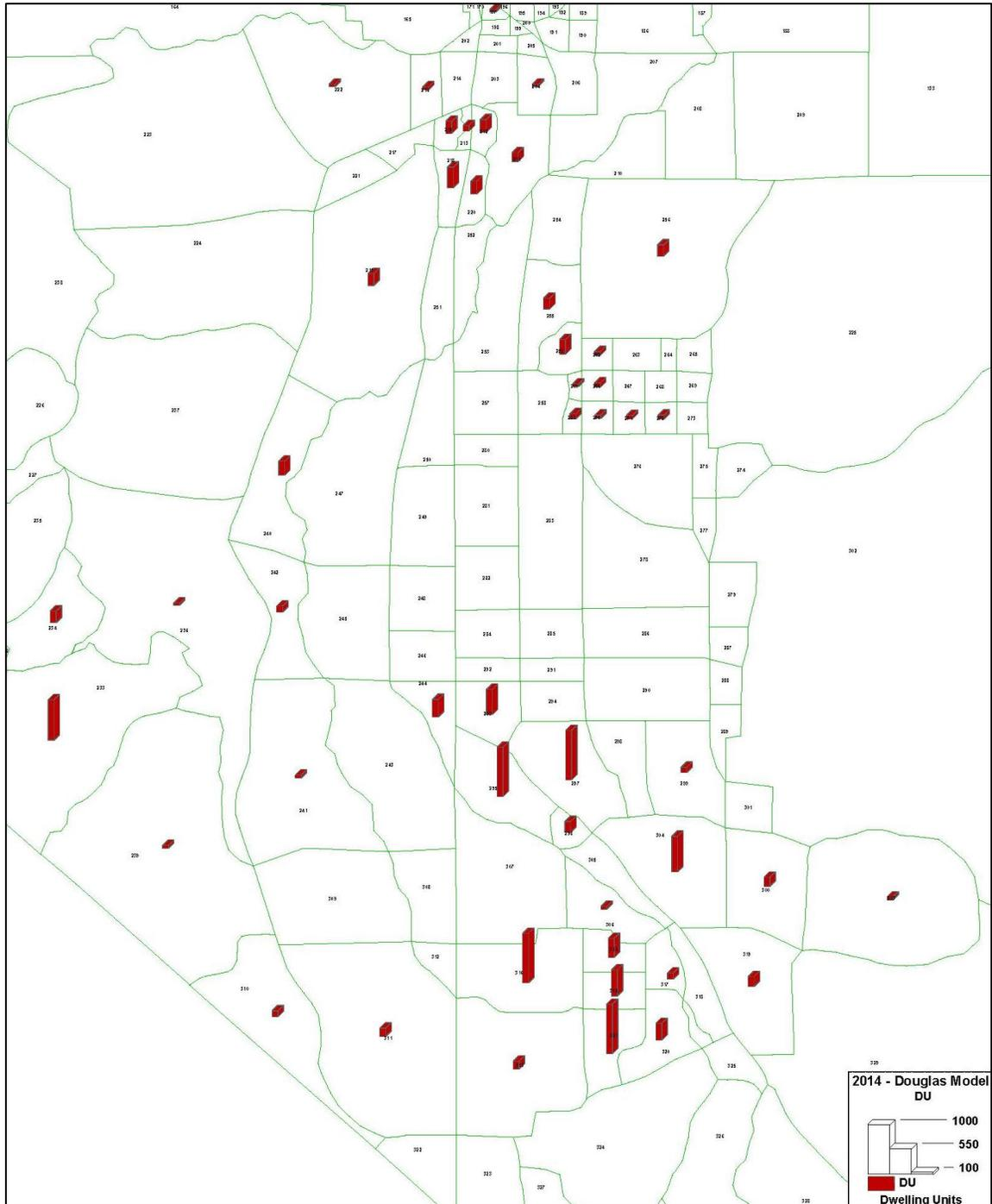

Douglas County/Carson City Regional Travel Demand Model

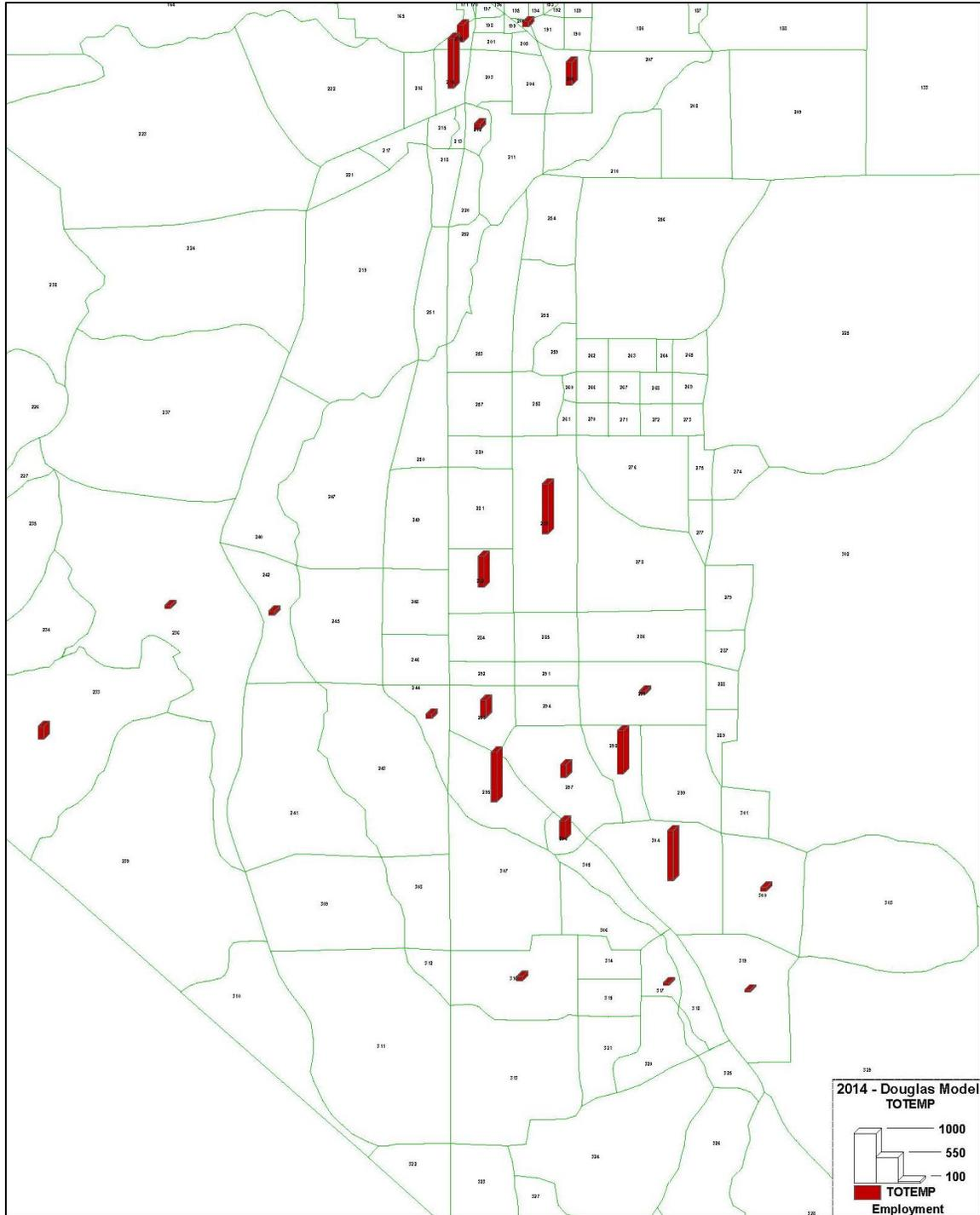

Appendix C: Douglas County and Carson City Industries and Travel Demand Model, Employment by Category

SIC_CODE	Industry	Trade_Name	Employment	Model_Category	Total_Emp
484121	General Freight Trucking, Long-Dist TL	Prime Worldwide Inc	3	Other	3
814110	Private Households	Carl W Rase	15	Other	15
814110	Private Households	James R Marshall	3	Other	3
721120	Casino Hotels	Topaz Lodge & Casino	150	Hotel_G	150
112111	Beef Cattle Ranching and Farming	Park Livestock Co Inc	15	Other	15
922190	Other Justice and Safety Activities	Federal Emergency Mgmt Agency	3	Office_G	3
926140	Agricultural Commodity/Market Regulation	Food Safety and Inspection Service	3	Office_G	3
721110	Hotels (except Casino Hotels) and Motels	Best Western Topaz Lake Inn	3	Hotel_NG	3
236117	New Housing Operative Builders	Booth Custom Homes LLC	3	Constru	3
112111	Beef Cattle Ranching and Farming	Kamtec Inc	3	Other	3
722511	Full-Service Restaurants	Franciscos	15	Food_Dr	15
621111	Offices of Physicians, ex. Mental Health	Carson Valley Medical Center	3	Medical	3
445110	Supermarkets and Other Grocery Stores	Nevada Trading Company	15	Retail	15
453998	Store Retailers Not Specified Elsewhere	Big Blue Spa Service & Repair	3	Retail	3
237310	Highway, Street, and Bridge Construction	Tregid Road Dept	15	Constru	15
445120	Convenience Stores	Holbrook Station Mini Mart	3	Retail	3
442291	Window Treatment Stores	Judy's Window Coverings	7	Retail	7
722513	Limited-Service Restaurants	Burger King	25	Food_Dr	25
491110	Postal Service	USPS Gardnerville	15	Other	15
445110	Supermarkets and Other Grocery Stores	Raley's	75	Retail	75
561730	Landscaping Services	Big Valley Landscaping	3	Other	3
561730	Landscaping Services	Terrys Landscape Service LLC	1	Other	1
621111	Offices of Physicians, ex. Mental Health	Minden Medical Center	25	Medical	25
238221	Residential Plumbing/HVAC Contractors	Latin Plumbing	3	Constru	3
425120	Wholesale Trade Agents and Brokers	Vogel Traffic Services Inc	3	Other	3
541211	Offices of Certified Public Accountants	Ella K Laden CPA	1	Office_P	1
813312	Environment & Conservation Organizations	Nevada B Ranch Mustang Sanctuary	7	Office_P	7
541940	Veterinary Services	Great Basin Equine Medicine &	3	Office_P	3
541219	Other Accounting Services	Account Ability Inc	1	Office_P	1
531120	Lessors of Nonresidential Buildings	TDL Property Mgmt Co Inc	1	Office_P	1
238212	Nonresidential Electrical Contractors	Macadee Electrical Constructio	3	Constru	3
238912	Nonresidential Site Preparation Contrs	Silver State Boring	7	Constru	7

Douglas County/Carson City Regional Travel Demand Model

SIC_CODE	Industry	Trade_Name	Employment	Model_Category	Total_Emp
238141	Residential Masonry Contractors	Kawcak Masonry Inc	7	Constru	7
484220	Other Specialized Trucking, Local	Santos Trucking Inc	3	Other	3
236115	New Single-Family Housing Construction	Seward Homes Inc	3	Constru	3
561730	Landscaping Services	CB Landscaping	7	Other	7
561720	Janatorial Services	Get Er Done Cleaning Service	3	Other	3
531120	Lessors of Nonresidential Buildings	Trans-Sierra Investments Inc	3	Office_P	3
611620	Sports and Recreation Instruction	Carson Ata Blackbelt Academy L	3	School	3
238191	Other Residential Exterior Contractors	Rainbo Tims Concrete	7	Constru	7
531110	Lessors of Residential Buildings	Vista Ventures Asset Managemen	1	Office_P	1
236115	New Single-Family Housing Construction	A+ Engineering Construction	3	Constru	3
236220	Commercial Building Construction	RC Strong Construction	1	Constru	1
236115	New Single-Family Housing Construction	Nevada Johnson Inc	7	Constru	7
523910	Miscellaneous Intermediation	Bstock LLC	3	Office_P	3
238341	Residential Tile/Terrazzo Contractors	Randy Isaacs Ceramic Tile	3	Constru	3
561730	Landscaping Services	Desert Star Landscaping	7	Other	7
624120	Services for the Elderly and Disabled	Brandon Winberg	1	Other	1
541690	Other Technical Consulting Services	AG NV Inc	3	Office_P	3
238211	Residential Electrical Contractors	Ramos Electric Llc	3	Constru	3
814110	Private Households	Philip M Rhodes	3	Other	3
924120	Administration of Conservation Programs	Fish And Wildlife Serv	7	Office_G	7
561740	Carpet and Upholstery Cleaning Services	High Sierra Chem-Dry of Dougla	3	Other	3
561730	Landscaping Services	Sierra Peaks Enterprises LLC	7	Other	7
551114	Managing Offices	Juki Automation Systems Inc	3	Office_P	3
561730	Landscaping Services	Robert H Boman Gardening	3	Other	3
561730	Landscaping Services	Elkhorn Landscape LLC	3	Other	3
425120	Wholesale Trade Agents and Brokers	Bose	3	Other	3
541611	Administrative Management Consulting Svc	David G Bauer Associates Inc	3	Office_P	3
238321	Residential Painting Contractors	Powers Painting	3	Constru	3
522310	Mortgage and Nonmortgage Loan Brokers	High Sierra Mortgage Co	3	Office_P	3
236118	Residential Remodelers	MCBC Inc	3	Constru	3
812990	All Other Personal Services	Butter + Salt Inc	3	Other	3
722513	Limited-Service Restaurants	Nik N Willies Pizza	7	Food_Dr	7
561730	Landscaping Services	Carson Valley Lawn And Garden	3	Other	3
999999	Unknown Industry	John Colyer Enterprises Llc	3	Other	3
236118	Residential Remodelers	Walter & Walter Construction L	3	Constru	3
237310	Highway, Street, and Bridge Construction	White Rock Construction Inc	3	Constru	3

Douglas County/Carson City Regional Travel Demand Model

SIC_CODE	Industry	Trade_Name	Employment	Model_Category	Total_Emp
721214	Recreational and Vacation Camps	Catholic Heart Workcamp NV	3	Other	3
425120	Wholesale Trade Agents and Brokers	Ludeca Inc	3	Other	3
541219	Other Accounting Services	New Vista Building Corp	1	Office_P	1
623312	Homes for the Elderly	Carson Valley Residential Care	3	Other	3
623312	Homes for the Elderly	Carson Valley Senior Living LI	25	Other	25
813410	Civic and Social Organizations	Tahoe/Douglas Elks Lodge #2670	3	Office_P	3
561790	Other Services to Buildings & Dwellings	Incline Village Hot Tub	3	Other	3
212321	Construction Sand and Gravel Mining	Bing Materials	35	Other	35
445310	Beer, Wine, and Liquor Stores	Rancho Liquor 99 Cents & More	3	Retail	3
722513	Limited-Service Restaurants	Hunan Chinese Restaurant	7	Food_Dr	7
541712	Research and Development in the Physical, Eng	Broadcom Corporation	1	Office_P	1
812910	Pet Care (except Veterinary) Services	Brendas Pet Styling	3	Retail	3
722511	Full-Service Restaurants	Philadelphia Restaurant & Sand	7	Food_Dr	7
722513	Limited-Service Restaurants	Pronto Pizza	7	Food_Dr	7
445310	Beer, Wine, and Liquor Stores	JM Discount Liquor	3	Retail	3
445310	Beer, Wine, and Liquor Stores	PJs Liquor & Wine Shope	1	Retail	1
445310	Beer, Wine, and Liquor Stores	PJs Liquor And Fine Wine Shop	3	Retail	3
711510	Independent Artists/Writers/Performers	Desert Pines Taxidermy	1	Other	1
722515	Snack and Nonalcoholic Beverage Bars	Honu Coffee	3	Food_Dr	3
238131	Residential Framing Contractors	Jeff Hall Construction Inc	15	Constru	15
624120	Services for the Elderly and Disabled	Washoe Tribe of NV & Calif	7	Other	7
445110	Supermarkets and Other Grocery Stores	Dollar General	7	Retail	7
311920	Coffee and Tea Manufacturing	Blind Dog Coffee Roasters	7	Goods_P	7
333993	Packaging Machinery Manufacturing	Bert Manufacturing LLC	3	Goods_P	3
447110	Gasoline Stations w/ Convenience Stores	7-Eleven #22590B	15	Retail	15
523120	Securities Brokerage	Jones, Edward D & Company	3	Office_P	3
722410	Drinking Places (Alcoholic Beverages)	Moose and Squirrel, The	7	Food_Dr	7
722511	Full-Service Restaurants	Grill Next Door, The	3	Food_Dr	3
561730	Landscaping Services	Big Fish Landscaping Inc	7	Other	7
722513	Limited-Service Restaurants	Pizza Factory	7	Food_Dr	7
531130	Miniwarehouses and Self-Storage Unit	Acme Boat & RV Storage	3	Office_P	3
531130	Miniwarehouses and Self-Storage Unit	Stor-All	3	Office_P	3
531130	Miniwarehouses and Self-Storage Unit	Stor-All	3	Office_P	3
541720	Social Science/Humanities Research	Family Health International	3	Office_P	3
236118	Residential Remodelers	Inside Out Construction & Main	3	Constru	3
238221	Residential Plumbing/HVAC Contractors	Eric's Plumbing Inc	3	Constru	3

Douglas County/Carson City Regional Travel Demand Model

SIC_CODE	Industry	Trade_Name	Employment	Model_Category	Total_Emp
332994	Small Arms Manufacturing	Billet Rifle Systems LLC	3	Goods_P	3
236115	New Single-Family Housing Construction	Jack S Hall Construction	3	Constru	3
238222	Nonresidential Plumbing/HVAC Contractors	Summit Refrigeration Inc	3	Constru	3
236115	New Single-Family Housing Construction	Hansen Construction Inc	3	Constru	3
238161	Residential Roofing Contractors	Tom Goldston Roofing Inc	15	Constru	15
236118	Residential Remodelers	Clark Builders	3	Constru	3
236115	New Single-Family Housing Construction	Bennett Construction	3	Constru	3
425120	Wholesale Trade Agents and Brokers	Zing Communications Inc	1	Other	1
236118	Residential Remodelers	William Tremaine Construction	7	Constru	7
236220	Commercial Building Construction	Dugan Commercial Builders	7	Constru	7
236115	New Single-Family Housing Construction	Edmunds Construction	7	Constru	7
531110	Lessors of Residential Buildings	Washoe Housing Authority	15	Office_P	15
624190	Other Individual and Family Services	Washoe Tribe of NV & Calif	7	Other	7
624120	Services for the Elderly and Disabled	Dresslerville Colony	3	Other	3
621111	Offices of Physicians, ex. Mental Health	Washoe Tribe Health Clinic	55	Medical	55
611630	Language Schools	Washoe Wagayay Manal	3	School	3
624410	Child Day Care Services	Dresslerville Head Start	3	Other	3
561730	Landscaping Services	Davenport Landscape & Design L	7	Other	7
238211	Residential Electrical Contractors	High Desert Electric Inc	3	Constru	3
238352	Nonresidential Finish Carpentry Contrs	Trinity Millwork	3	Constru	3
541511	Custom Computer Programming Services	Global Aerospace Corporation	3	Office_P	3
111940	Hay Farming	Corley Ranches LLC	3	Other	3
562991	Septic Tank and Related Services	Bobulas Septic Service	3	Other	3
221310	Water Supply and Irrigation Systems	Sierra Water Management	3	Goods_P	3
541618	Other Management Consulting Services	PTS	3	Office_P	3
624110	Child and Youth Services	Tomacina Hochgurtel	1	Other	1
238992	All Other Nonresidential Trade Contrs	Scott Sealing & Striping	7	Constru	7
236118	Residential Remodelers	Lorick Enterprises Inc	3	Constru	3
333911	Pump and Pumping Equipment Manufacturing	Simple Pump Company LLC	3	Goods_P	3
561740	Carpet and Upholstery Cleaning Services	AAA Garys Carpet Care	3	Other	3
551114	Managing Offices	Phillips Plastics Corporation	3	Office_P	3
813990	Other Similar Organizations	Sequoia Village Homeowners Ass	3	Office_P	3
236118	Residential Remodelers	RK Perra Construction	1	Constru	1
444220	Nursery, Garden & Farm Supply Stores	Comstock Seed	7	Retail	7
541611	Administrative Management Consulting Svc	Samcin Corporation	3	Office_P	3
621399	Offices of Misc Health Practitioners	Dr Lorraine Platka-Bird Inc	3	Medical	3

Douglas County/Carson City Regional Travel Demand Model

SIC_CODE	Industry	Trade_Name	Employment	Model_Category	Total_Emp
238221	Residential Plumbing/HVAC Contractors	MCA Mechanical Inc	3	Constru	3
561730	Landscaping Services	Naturescape	3	Other	3
921150	Tribal Governments	Washoe Tribe of Nv & Calif	35	Office_G	35
337110	Wood Kitchen Cabinets and Countertops	Creative Woodworks Inc	1	Goods_P	1
814110	Private Households	Norman J Reith	3	Other	3
238992	All Other Nonresidential Trade Contrs	Connolly Crane Service Inc	15	Constru	15
624410	Child Day Care Services	Under the Magic Pine Tree Inc	7	Other	7
484220	Other Specialized Trucking, Local	Sierra Tahoe Transport	3	Other	3
488510	Freight Transportation Arrangement	Mountain States Transport Inc	1	Office_P	1
221310	Water Supply and Irrigation Systems	Gardnerville Ranchos G.I.D	7	Goods_P	7
236115	New Single-Family Housing Construction	BDR Construction	7	Constru	7
238311	Residential Drywall Contractors	Sierra Drywall Inc	7	Constru	7
323113	Commercial Screen Printing	Signs of Excitement	1	Goods_P	1
454390	Other Direct Selling Establishments	Whiskers & Paws/Pet Chef Express	1	Retail	1
561730	Landscaping Services	Alpine Landscape Service	3	Other	3
444220	Nursery, Garden & Farm Supply Stores	Rice Enterprises Inc	15	Retail	15
541690	Other Technical Consulting Services	Advancing Global Wellness Inc	3	Office_P	3
811111	General Automotive Repair	PM Plus Mobile Repair	3	Retail	3
541219	Other Accounting Services	Health Care Professionals Bill	1	Office_P	1
814110	Private Households	Britt Jones	3	Other	3
541511	Custom Computer Programming Services	Powertrusion International Inc	3	Office_P	3
238221	Residential Plumbing/HVAC Contractors	Pro Plumbing Inc	3	Constru	3
238211	Residential Electrical Contractors	Pigman Electric	3	Constru	3
623312	Homes for the Elderly	Riverview Manor	7	Other	7
531210	Offices of Real Estate Agents & Brokers	Nelson And Shizuru Inc	1	Office_P	1
236118	Residential Remodelers	Kevin Tierney Construction	1	Constru	1
236118	Residential Remodelers	Kevin Tieney Construction	3	Constru	3
314999	All Other Textile Product Mills	Magic Stitches Inc	1	Goods_P	1
236115	New Single-Family Housing Construction	Greg Lynn Construction LLC	3	Constru	3
238322	Nonresidential Painting Contractors	Lapco	15	Constru	15
561720	Janatorial Services	Cassidy Classic Cleaning	7	Other	7
238141	Residential Masonry Contractors	Hakansson Masonry	3	Constru	3
236115	New Single-Family Housing Construction	John M Moss General Contractor	3	Constru	3
454210	Vending Machine Operators	SPS Cleaning & Carson Valley P	7	Retail	7
532299	All Other Consumer Goods Rental	Sierra Canopy Rentals	1	Other	1
541330	Engineering Services	Blue Frog-West Inc	3	Office_P	3

Douglas County/Carson City Regional Travel Demand Model

SIC_CODE	Industry	Trade_Name	Employment	Model_Category	Total_Emp
551114	Managing Offices	Mangan Nc	3	Office_P	3
541214	Payroll Services	W R Bloomer Company Inc	3	Office_P	3
236115	New Single-Family Housing Construction	D E Jansse & Company Inc	7	Constru	7
713910	Golf Courses and Country Clubs	Carson Valley Golf Course Inc	35	Other	35
611710	Educational Support Services	Advanced Academics Inc	1	School	1
722511	Full-Service Restaurants	Carson Valley Country Club Restaura	15	Food_Dr	15
812910	Pet Care (except Veterinary) Services	Pet Sitters Plus LLC	7	Retail	7
337110	Wood Kitchen Cabinets and Countertops	D & B Cabinets	3	Goods_P	3
624110	Child and Youth Services	Julie A Meadors	3	Other	3
236220	Commercial Building Construction	Brian Ross Construction Inc	3	Constru	3
921150	Tribal Governments	Washoe Tribe of NV & Calif	15	Office_G	15
924110	Air, Water and Waste Program Admin	Washoe Tribe of NV & Calif	15	Office_G	15
453991	Tobacco Stores	Washoe One Stop	7	Retail	7
624410	Child Day Care Services	Sunshine and Rainbows	7	Other	7
561622	Locksmiths	Accurate Mobile Locksmith	3	Other	3
561621	Security Systems Services, ex. Locksmith	NU-Systems	15	Other	15
238911	Residential Site Preparation Contractors	BR Constructors Llc	7	Constru	7
238911	Residential Site Preparation Contractors	Impact Construction	3	Constru	3
236115	New Single-Family Housing Construction	Cenak Builders Inc	3	Constru	3
236115	New Single-Family Housing Construction	TGS Construction Co	15	Constru	15
238341	Residential Tile/Terrazzo Contractors	Sundance Tile & Marble Llc	7	Constru	7
336310	Motor Vehicle Gasoline Engine and Engine Part	Douglas Machine Service	3	Goods_P	3
442210	Floor Covering Stores	Fields of Flooring	3	Retail	3
524210	Insurance Agencies and Brokerages	Triple A Funding Corporation	3	Office_P	3
524210	Insurance Agencies and Brokerages	Michael Boyd Insurance Solutio	3	Office_P	3
541611	Administrative Management Consulting Svc	Panacal Inc	3	Office_P	3
551114	Managing Offices	American Poly Foam Co Inc	3	Office_P	3
561730	Landscaping Services	Sundown Landscape	1	Other	1
561730	Landscaping Services	Velasquez Landscaping	3	Other	3
624110	Child and Youth Services	Tawnya Ramos	1	Other	1
722511	Full-Service Restaurants	Jethros Oven & Grille	25	Food_Dr	25
541611	Administrative Management Consulting Svc	Benefit Consultants Inc	3	Office_P	3
238111	Residential Poured Foundation Contractor	Class Enterprises	3	Constru	3
621210	Offices of Dentists	Sierra View Dental	15	Medical	15
447110	Gasoline Stations w/ Convenience Stores	7-Eleven Store 2236-23074D	7	Retail	7
238131	Residential Framing Contractors	Sizelove Construction & Devel	3	Constru	3

Douglas County/Carson City Regional Travel Demand Model

SIC_CODE	Industry	Trade_Name	Employment	Model_Category	Total_Emp
238991	All Other Residential Trade Constructors	M Sqrd Masonry Inc	7	Constru	7
551114	Managing Offices	McDermid Management Co LLC	3	Office_P	3
531120	Lessors of Nonresidential Buildings	Lagunak Inc	3	Office_P	3
531120	Lessors of Nonresidential Buildings	Select Investments Inc	3	Office_P	3
541620	Environmental Consulting Services	A Biaggi & Associates LLC	1	Office_P	1
236118	Residential Remodelers	Griswold Construction	3	Constru	3
531110	Lessors of Residential Buildings	Telco Interests Ltd	3	Office_P	3
238912	Nonresidential Site Preparation Contrs	Crockett Enterprises Inc	3	Constru	3
112111	Beef Cattle Ranching and Farming	F Heise Land & Livestock Co In	1	Other	1
236220	Commercial Building Construction	Neenan Company LLP, The	3	Constru	3
541512	Computer Systems Design Services	Carson Valley Medical Center	3	Office_P	3
621111	Offices of Physicians, ex. Mental Health	First Choice Anesthesia Consul	3	Medical	3
621910	Ambulance Services	Care Flight	7	Medical	7
622110	General Medical and Surgical Hospitals	Carson Valley Medical Center	250	Medical	250
333514	Special Tools, Dies, Jigs, and Fixtures	A N C Precision Machining Inc	7	Goods_P	7
444220	Nursery, Garden & Farm Supply Stores	Valley Garden Center LLC	7	Retail	7
238321	Residential Painting Contractors	Gary Newell Designs	1	Constru	1
621111	Offices of Physicians, ex. Mental Health	Carson Valley Pulmonary	3	Medical	3
621391	Offices of Podiatrists	Sierra Foot & Ankle PC	3	Medical	3
621391	Offices of Podiatrists	Sierra Mgmt Institute Inc	7	Medical	7
621111	Offices of Physicians, ex. Mental Health	Scott W Southard MD Inc	3	Medical	3
237110	Water and Sewer System Construction	Kevin Obrien Construction LLC	7	Constru	7
621210	Offices of Dentists	Edward J Gray DMD Ltd	7	Medical	7
238911	Residential Site Preparation Contractors	Knox Excavating	7	Constru	7
441320	Tire Dealers	Mark Smith Tire Center Inc	15	Retail	15
561320	Temporary Help Services	Fusion Medical Staffing	7	Office_P	7
623312	Homes for the Elderly	Emeritus At Gardnerville	55	Other	55
522320	Financial Transaction Process/Clearing	Damar Merchant Services	3	Office_P	3
484121	General Freight Trucking, Long-Dist TL	Guided Truck And Equipment	7	Other	7
238911	Residential Site Preparation Contractors	GE Excavating	7	Constru	7
561720	Janatorial Services	Gardnerville Healthrehab	3	Other	3
621340	Offices of Specialty Therapists	Evergreen at Gardnerville	15	Medical	15
623110	Nursing Care Facilities	Evergrn Gardnerville Hlth & Re	55	Other	55
541213	Tax Preparation Services	Jackson Hewitt	1	Office_P	1
221310	Water Supply and Irrigation Systems	Gardnerville Town Water Co	15	Goods_P	15
452910	Warehouse Clubs and Supercenters	Wal-Mart Supercenter	250	Super_C	250

Douglas County/Carson City Regional Travel Demand Model

SIC_CODE	Industry	Trade_Name	Employment	Model_Category	Total_Emp
621399	Offices of Misc Health Practitioners	The Clinic at Walmart	3	Medical	3
722513	Limited-Service Restaurants	Subway	15	Food_Dr	15
812112	Beauty Salons	Smart Style	3	Retail	3
325510	Paint and Coating Manufacturing	Aervoe Industries Incorporated	75	Goods_P	75
112111	Beef Cattle Ranching and Farming	Hussman Land & Livestock Co In	3	Other	3
321911	Wood Window and Door Manufacturing	Valley Door Works	1	Goods_P	1
532412	Other Heavy Machinery Rental and Leasing	Ahern Rentals Inc	15	Other	15
447110	Gasoline Stations w/ Convenience Stores	Golden Gate Gardnerville	7	Retail	7
484220	Other Specialized Trucking, Local	Nicholson Trucking Inc	7	Other	7
531130	Miniwarehouses and Self-Storage Unit	Public Storage	3	Office_P	3
238211	Residential Electrical Contractors	Central Systems Electric Inc	3	Constru	3
561422	Telemarketing Bureaus	Target Advertising	3	Office_P	3
237130	Power/Communication System Construction	Curtis & Sons Construction Inc	25	Constru	25
326199	All Other Plastics Product Manufacturing	Jcp Enterprises Inc	15	Goods_P	15
541940	Veterinary Services	Jobs Peak Vet Hosp Inc	15	Office_P	15
488410	Motor Vehicle Towing	Emerald Bay Towing	3	Other	3
811118	Other Automotive Mechanical Repair	Douglas Radiator and Auto Air	3	Retail	3
541330	Engineering Services	Swartz And Kulpa Enginrng Inc	3	Office_P	3
811111	General Automotive Repair	Double J Auto	3	Retail	3
811111	General Automotive Repair	Mccomas Automotive	1	Retail	1
541690	Other Technical Consulting Services	Lm Global Consulting LLC	1	Office_P	1
322230	Stationery Product Manufacturing	Wci Index & Filing LLC	3	Goods_P	3
339950	Sign Manufacturing	Carson Valley Signs	1	Goods_P	1
811111	General Automotive Repair	Gesselmans Garage LLC	3	Retail	3
541940	Veterinary Services	Carson Valley Large Animal Cli	3	Office_P	3
238221	Residential Plumbing/HVAC Contractors	Summit Plumbing Co LLC	15	Constru	15
522320	Financial Transaction Process/Clearing	Petro Payment Services Inc	1	Office_P	1
332721	Precision Turned Product Manufacturing	Jaguar Precision	7	Goods_P	7
238291	Other Residential Equipment Contractors	J & S Digital Satellite	7	Constru	7
451110	Sporting Goods Stores	Bullseye Nevada	3	Retail	3
454310	Fuel Dealers	Bi-State Propane	3	Retail	3
722511	Full-Service Restaurants	Ham Dogs Inc	15	Food_Dr	15
722513	Limited-Service Restaurants	Full Belly Deli	1	Food_Dr	1
812910	Pet Care (except Veterinary) Services	Fuzzy Paws Pet Grooming LLC	1	Retail	1
238151	Residential Glass/Glazing Contractors	Sweetwater Glass Company	3	Constru	3
541940	Veterinary Services	R P Wallstru DVM Inc	3	Office_P	3

Douglas County/Carson City Regional Travel Demand Model

SIC_CODE	Industry	Trade_Name	Employment	Model_Category	Total_Emp
332710	Machine Shops	Luiss Automatics	3	Goods_P	3
441310	Automotive Parts and Accessories Stores	NC Auto Parts, LLC	1	Retail	1
811310	Commercial Machinery Repair/Maintenance	Buffos Refrigeration	3	Retail	3
531130	Miniwarehouses and Self-Storage Unit	Stor-All	3	Office_P	3
811121	Automotive Body and Interior Repair	Norris Auto Body	15	Retail	15
811111	General Automotive Repair	M & B Enterprises	3	Retail	3
611420	Computer Training	Total Training Inc	1	School	1
238161	Residential Roofing Contractors	Bgs Builders/Roofing LLC	3	Constru	3
811111	General Automotive Repair	Carson Valley Import Auto	3	Retail	3
811121	Automotive Body and Interior Repair	Superior Collision Center	3	Retail	3
332721	Precision Turned Product Manufacturing	Beres Precision Inc	7	Goods_P	7
238131	Residential Framing Contractors	J C Merrithew Construction Co	3	Constru	3
444190	Other Building Material Dealers	Silver State Roofing Materials	7	Retail	7
238221	Residential Plumbing/HVAC Contractors	Jackrabbit Plumbing Inc	15	Constru	15
442299	All Other Home Furnishings Stores	Aj's Stoves	3	Retail	3
238911	Residential Site Preparation Contractors	I & S Excavation Llc	3	Constru	3
453910	Pet and Pet Supplies Stores	Laxague Feed & Supply	3	Retail	3
532299	All Other Consumer Goods Rental	Entertainer, The	7	Other	7
811111	General Automotive Repair	Stafford Automotive	3	Retail	3
811111	General Automotive Repair	Golden Nugget Automotive	7	Retail	7
311421	Fruit and Vegetable Canning	Italian Hearts Pasta Sauces In	3	Goods_P	3
811111	General Automotive Repair	Standard Diesel And Repair Com	7	Retail	7
238161	Residential Roofing Contractors	Woodward Quality Roofing Llc	3	Constru	3
238221	Residential Plumbing/HVAC Contractors	Carson Valley Heating Inc	7	Constru	7
238221	Residential Plumbing/HVAC Contractors	Dukes Plumbing Heating & Air	1	Constru	1
238221	Residential Plumbing/HVAC Contractors	Dukes Plumbing Heating & Air I	7	Constru	7
339116	Dental Laboratories	Reid Dental Ceramics	3	Goods_P	3
811111	General Automotive Repair	Bobs Performance Center Inc	7	Retail	7
424720	Other Petroleum Merchant Wholesalers	Conquest West Incorporated	3	Ware_H	3
441320	Tire Dealers	All American Tire & Automotive	3	Retail	3
561730	Landscaping Services	Joe Benigno Tree Service & Sno	15	Other	15
444190	Other Building Material Dealers	Meeks Building Center	15	Retail	15
561730	Landscaping Services	Total Lawn & Landscape Inc	7	Other	7
562219	Other Nonhazardous Waste Disposal	Tahoe Basin Container Service	35	Goods_P	35
561790	Other Services to Buildings & Dwellings	Protokleen Inc	15	Other	15
561790	Other Services to Buildings & Dwellings	Industrial Services	3	Other	3

Douglas County/Carson City Regional Travel Demand Model

SIC_CODE	Industry	Trade_Name	Employment	Model_Category	Total_Emp
444220	Nursery, Garden & Farm Supply Stores	Pinenut Livestock Supply Inc	7	Retail	7
811121	Automotive Body and Interior Repair	Morts Auto Body Inc	7	Retail	7
238221	Residential Plumbing/HVAC Contractors	York Plumbing Inc	3	Constru	3
811111	General Automotive Repair	Hendricks Automotive & 4x4 Inc	3	Retail	3
811111	General Automotive Repair	Bob Berrys Autotrans	3	Retail	3
444210	Outdoor Power Equipment Stores	ASJ Small Engines Etc	3	Retail	3
444130	Hardware Stores	ACE Hardware	15	Retail	15
811111	General Automotive Repair	Gardnerville Automotive	3	Retail	3
424450	Confectionery Merchant Wholesalers	Rolling Frito-Lay Sales LP	3	Ware_H	3
444110	Home Centers	PR Imports And Supply	3	Retail	3
811191	Automotive Oil Change/Lubrication Shops	Jiffy Lube	7	Retail	7
811113	Automotive Transmission Repair	Carson Valley Transmission Inc	3	Retail	3
811192	Car Washes	Grand Prix Express Car Wash	7	Retail	7
541611	Administrative Management Consulting Svc	Great Basin Advisors Ltd	1	Office_P	1
523930	Investment Advice	Wilshire Associates Inc	3	Office_P	3
531312	Nonresidential Property Managers	Hone Company	3	Office_P	3
453910	Pet and Pet Supplies Stores	Eastern Sierra Feed Inc	15	Retail	15
624190	Other Individual and Family Services	Family Support Cncl of Doug Co	7	Other	7
621210	Offices of Dentists	Dragon Dental Inc	7	Medical	7
624110	Child and Youth Services	Washoe Tribe of NV & Calif	7	Other	7
624190	Other Individual and Family Services	Washoe Tribe of NV & Calif	35	Other	35
522110	Commercial Banking	Heritage Bank	7	Office_P	7
624410	Child Day Care Services	Sunflower Learning Center LLC	15	Other	15
561720	Janatorial Services	Bigg Impressions Cleaning Serv	3	Other	3
425120	Wholesale Trade Agents and Brokers	IUT Corporation	3	Other	3
451110	Sporting Goods Stores	Big Daddy Bikes	3	Retail	3
453310	Used Merchandise Stores	Cheshire Antiques Inc	1	Retail	1
515112	Radio Stations	Carson Valley Radio Inc	1	Office_P	1
541110	Offices of Lawyers	Law Ofc of Ronald F Cauley Inc	3	Office_P	3
722511	Full-Service Restaurants	Overland Hotel & Bar	3	Food_Dr	3
236115	New Single-Family Housing Construction	Rw Construction	1	Constru	1
522292	Real Estate Credit	Nevada Lenders Inc	3	Office_P	3
621111	Offices of Physicians, ex. Mental Health	Helix Medical Group	1	Medical	1
531311	Residential Property Managers	Crestmore Village	3	Office_P	3
541620	Environmental Consulting Services	Atmaa Inc	3	Office_P	3
238211	Residential Electrical Contractors	Jepson Electric	3	Constru	3

Douglas County/Carson City Regional Travel Demand Model

SIC_CODE	Industry	Trade_Name	Employment	Model_Category	Total_Emp
517110	Wired Telecommunications Carriers	Charter Communications	25	Office_P	25
531210	Offices of Real Estate Agents & Brokers	Remax Realty Affiliates	3	Office_P	3
611620	Sports and Recreation Instruction	Northwest Martial Arts Inc	3	School	3
524291	Claims Adjusting	State Farm Fire & Casualty Company	3	Office_P	3
238221	Residential Plumbing/HVAC Contractors	Country Comfort Aire	3	Constru	3
531210	Offices of Real Estate Agents & Brokers	Scott M Smith Inc	1	Office_P	1
531210	Offices of Real Estate Agents & Brokers	Re/Max	3	Office_P	3
531210	Offices of Real Estate Agents & Brokers	Donna V Easley	3	Office_P	3
531210	Offices of Real Estate Agents & Brokers	Re/Max Realty Affiliates	7	Office_P	7
531210	Offices of Real Estate Agents & Brokers	Great Nevada Homes Inc	7	Office_P	7
561730	Landscaping Services	A & C Landscaping Inc	3	Other	3
531320	Offices of Real Estate Appraisers	Silver Creek Appraisals Inc	3	Office_P	3
561920	Convention and Trade Show Organizers	Action Motivation Inc	1	Office_P	1
541611	Administrative Management Consulting Svc	Control Tower Inc, The	1	Office_P	1
541830	Media Buying Agencies	Gray Matter	7	Office_P	7
441320	Tire Dealers	Bridgestone Retail Operations LLC	7	Retail	7
541613	Marketing Consulting Services	Aquila Enterprises Inc	1	Office_P	1
423730	HVAC Goods Merchant Wholesalers	Knowles Inc	3	Ware_H	3
425120	Wholesale Trade Agents and Brokers	Alloc Inc	1	Other	1
441310	Automotive Parts and Accessories Stores	Autozone	15	Retail	15
443141	Household Appliance Stores	Carson Valley Vac and Sew	3	Retail	3
443142	Electronics Stores	Carson Valley Electronics	3	Retail	3
443142	Electronics Stores	Wireless Store	7	Retail	7
446110	Pharmacies and Drug Stores	Rite Aid	25	Retail	25
448140	Family Clothing Stores	Angelos	1	Retail	1
448210	Shoe Stores	Payless Shoes	7	Retail	7
453220	Gift, Novelty, and Souvenir Stores	BFD USA Inc	1	Retail	1
522291	Consumer Lending	USA Cash Services	3	Office_P	3
551114	Managing Offices	Altaspark Ventures	1	Office_P	1
561720	Janatorial Services	A M S	25	Other	25
722513	Limited-Service Restaurants	Port of Subs 61	7	Food_Dr	7
451130	Sewing, Needlework & Piece Goods Stores	Quilt House Inc, The	7	Retail	7
722511	Full-Service Restaurants	Thai Jasmine Inc	3	Food_Dr	3
722513	Limited-Service Restaurants	Subway	15	Food_Dr	15
236220	Commercial Building Construction	Tom Hoyle	1	Constru	1
722513	Limited-Service Restaurants	Round Table Pizza #908	25	Food_Dr	25

Douglas County/Carson City Regional Travel Demand Model

SIC_CODE	Industry	Trade_Name	Employment	Model_Category	Total_Emp
722515	Snack and Nonalcoholic Beverage Bars	Starbucks Coffee	25	Food_Dr	25
236115	New Single-Family Housing Construction	Doug Wilson Construction	3	Constru	3
447110	Gasoline Stations w/ Convenience Stores	Park Place AM-PM	15	Retail	15
722513	Limited-Service Restaurants	Kentucky Fried Chicken	15	Food_Dr	15
445110	Supermarkets and Other Grocery Stores	Smith's	85	Retail	85
522110	Commercial Banking	Us Bank National Assoc	3	Office_P	3
713290	Other Gambling Industries	Golden Gaming LLC	7	Other	7
722513	Limited-Service Restaurants	Jack in the Box	25	Food_Dr	25
541940	Veterinary Services	Animal Medical Services	7	Office_P	7
722513	Limited-Service Restaurants	Taco Bell	35	Food_Dr	35
446110	Pharmacies and Drug Stores	Walgreens	7	Retail	7
446110	Pharmacies and Drug Stores	Walgreens	15	Retail	15
443142	Electronics Stores	Spring Mobile	3	Retail	3
531210	Offices of Real Estate Agents & Brokers	Bodenstein Insurance & Real Estate	7	Office_P	7
551114	Managing Offices	Kudma Inc	3	Office_P	3
713940	Fitness and Recreational Sports Centers	Anytime Fitness	3	Other	3
531210	Offices of Real Estate Agents & Brokers	Alpine Sierra LLC	3	Office_P	3
561990	All Other Support Services	Goodwill Industries of Sac Villy &	3	Other	3
518210	Data Processing and Related Services	Inka Solutions LLC	1	Office_P	1
541511	Custom Computer Programming Services	Adtumbler Inc	3	Office_P	3
721110	Hotels (except Casino Hotels) and Motels	Westerner Motel	3	Hotel_NG	3
115210	Support Activities for Animal Production	Cutter Ridge Ranch LLC	3	Other	3
722511	Full-Service Restaurants	Pizza Hut	15	Food_Dr	15
611699	Miscellaneous Schools and Instruction	National Corrective Group Inc	1	School	1
238211	Residential Electrical Contractors	S B Electric	3	Constru	3
531190	Lessors of Other Real Estate Property	Aspen Park	3	Office_P	3
447110	Gasoline Stations w/ Convenience Stores	Food Mart	3	Retail	3
621210	Offices of Dentists	Christopher J Comfort DDS PC	1	Medical	1
561730	Landscaping Services	B & B Landscaping Inc	7	Other	7
814110	Private Households	Lindsey D Wharton	1	Other	1
238911	Residential Site Preparation Contractors	Moline Builders Inc	3	Constru	3
311352	Confectionery Manufacturing from Purchased Ch	Chocolate Shoppe	3	Goods_P	3
453910	Pet and Pet Supplies Stores	Maxs Pet Supplies & Gifts	3	Retail	3
551114	Managing Offices	Bank of America Corporation	3	Office_P	3
722513	Limited-Service Restaurants	Papa Murphy's Take And Bake Pizza	15	Food_Dr	15
524210	Insurance Agencies and Brokerages	Intl Property & Casualty Ins	7	Office_P	7

Douglas County/Carson City Regional Travel Demand Model

SIC_CODE	Industry	Trade_Name	Employment	Model_Category	Total_Emp
112920	Horse and Other Equine Production	Maddi's Friesian Ranch LLC	7	Other	7
812320	Drycleaning and Laundry Services	R&T Cleaners	7	Retail	7
441310	Automotive Parts and Accessories Stores	O'Reilly Auto Parts	15	Retail	15
522310	Mortgage and Nonmortgage Loan Brokers	Wholesale Mortgage Services LI	3	Office_P	3
531311	Residential Property Managers	Cauley Property Management	3	Office_P	3
523120	Securities Brokerage	Jones, Edward D & Company	7	Office_P	7
238221	Residential Plumbing/HVAC Contractors	Scottsdale Plumbing Co	15	Constru	15
561720	Janatorial Services	Myers Enterprises	7	Other	7
561720	Janatorial Services	Ads-Myers Inc	15	Other	15
541940	Veterinary Services	Carson Valley Veterinary Hospital	55	Office_P	55
812910	Pet Care (except Veterinary) Services	Carson Valley Kennels & Groomi	7	Retail	7
722511	Full-Service Restaurants	Sierra Gourmet Grill and Wine	3	Food_Dr	3
814110	Private Households	Janet Parker	3	Other	3
445120	Convenience Stores	Lucky Discount Liquor	3	Retail	3
445120	Convenience Stores	Lucky Liquor #2	7	Retail	7
561730	Landscaping Services	Leonis Basque Gardener Inc	3	Other	3
624120	Services for the Elderly and Disabled	No Place Like Home	65	Other	65
721110	Hotels (except Casino Hotels) and Motels	Village Motel LLC	3	Hotel_NG	3
722511	Full-Service Restaurants	El Aguila Real Inc	7	Food_Dr	7
236220	Commercial Building Construction	Bellik Construction Inc	3	Constru	3
621420	Outpatient Mental Health Centers	Tahoe Youth and Family Service	7	Medical	7
722511	Full-Service Restaurants	New Rancho Grande, The	3	Food_Dr	3
441120	Used Car Dealers	Carson Valley Auto Sales	3	Retail	3
532111	Passenger Car Rental	Enterprise Leasing Company	3	Other	3
721110	Hotels (except Casino Hotels) and Motels	The Historian Inn	1	Hotel_NG	1
722511	Full-Service Restaurants	JT Basque Bar & Dining Room	25	Food_Dr	25
722410	Drinking Places (Alcoholic Beverages)	Nevada Ugly	7	Food_Dr	7
722410	Drinking Places (Alcoholic Beverages)	Buckaroos Saloon LLC	3	Food_Dr	3
722410	Drinking Places (Alcoholic Beverages)	French Bar	7	Food_Dr	7
621210	Offices of Dentists	James W Seyfried DDS PC	7	Medical	7
624110	Child and Youth Services	Mary E Busigin	3	Other	3
713210	Casinos (except Casino Hotels)	Sharkeys Nugget	55	Other	55
713290	Other Gambling Industries	Sharkeys Race & Sports Book	3	Other	3
522320	Financial Transaction Process/Clearing	Electronic Funds Company Inc	3	Office_P	3
541211	Offices of Certified Public Accountants	Chase & Sheets LLP Certified P	3	Office_P	3
541211	Offices of Certified Public Accountants	Chase Company Ltd Cert Pub Acc	3	Office_P	3

Douglas County/Carson City Regional Travel Demand Model

SIC_CODE	Industry	Trade_Name	Employment	Model_Category	Total_Emp
541219	Other Accounting Services	Stellar Business Services Inc	3	Office_P	3
541613	Marketing Consulting Services	Gmk Enterprises Inc	3	Office_P	3
453110	Florists	Art In Bloom Inc	7	Retail	7
112410	Sheep Farming	Borda Land & Sheep Co.	3	Goods_P	3
238141	Residential Masonry Contractors	Mcneely Masonry	3	Constru	3
453220	Gift, Novelty, and Souvenir Stores	Fresh Ideas / Polka Dots	3	Retail	3
448310	Jewelry Stores	Jewelry Repair By Hendrick	3	Retail	3
531210	Offices of Real Estate Agents & Brokers	Beverly Realty Inc	3	Office_P	3
541511	Custom Computer Programming Services	Clearsquare Associates	3	Office_P	3
561599	All Other Travel Arrangement Services	Tickvest Inc	3	Office_P	3
441310	Automotive Parts and Accessories Stores	Parts House, The	7	Retail	7
624110	Child and Youth Services	Rebecca S Johnson	1	Other	1
524210	Insurance Agencies and Brokerages	Upland Specialty Company	3	Office_P	3
561730	Landscaping Services	Nevada Landworks Corporation	15	Other	15
441310	Automotive Parts and Accessories Stores	1 Way Auto Care LLC	7	Retail	7
314120	Curtain and Linen Mills	Ellens Interiors	3	Goods_P	3
524292	Third Party Admin of Insurance Funds	Innovative Care Management Inc	3	Office_P	3
424990	Other Nondurable Goods Merchant Whsle	Bio Pure Products	3	Ware_H	3
561612	Security Guards and Patrol Services	Academy of Applied Security Se	1	Other	1
712110	Museums	Douglas Cty Historical Society	3	Other	3
813910	Business Associations	Business Council of Douglas Co	3	Office_P	3
813910	Business Associations	Carson Valley Chamber of Commerce	7	Office_P	7
541110	Offices of Lawyers	Law Office of Kathleen Kelly	3	Office_P	3
524210	Insurance Agencies and Brokerages	John Scott	7	Office_P	7
621210	Offices of Dentists	Stuart S Drange DDS A PC	7	Medical	7
238212	Nonresidential Electrical Contractors	Dufty Electric Inc	3	Constru	3
511210	Software Publishers	Siriusware Inc	3	Office_P	3
561990	All Other Support Services	Dowling Magnets	3	Other	3
621210	Offices of Dentists	Jay S Klapan DDS A Prof Corp	7	Medical	7
531320	Offices of Real Estate Appraisers	Marsha Williams LLC	3	Office_P	3
446191	Food (Health) Supplement Stores	Nutrition Unlimited	1	Retail	1
523120	Securities Brokerage	Jones, Edward D & Company	3	Office_P	3
541191	Title Abstract and Settlement Offices	Fidelity National Mgmt Servic	3	Office_P	3
722511	Full-Service Restaurants	Abby Jos Cafe Girasole	7	Food_Dr	7
238152	Nonresidential Glass/Glazing Contractors	Combos Glass Inc	3	Constru	3
236118	Residential Remodelers	Craftsman Construction LLC	1	Constru	1

Douglas County/Carson City Regional Travel Demand Model

SIC_CODE	Industry	Trade_Name	Employment	Model_Category	Total_Emp
811192	Car Washes	Sweetwater Car Wash LLC	3	Retail	3
722511	Full-Service Restaurants	Lentines Italian Resturant	3	Food_Dr	3
541110	Offices of Lawyers	Derrick M Lopez PC	3	Office_P	3
541211	Offices of Certified Public Accountants	Gregory V Holst	3	Office_P	3
722511	Full-Service Restaurants	Woodetts Diner	15	Food_Dr	15
814110	Private Households	Peter Axelson	3	Other	3
813110	Religious Organizations	Bromech Inc	1	Other	1
238222	Nonresidential Plumbing/HVAC Contractors	North Shore Dolomite Inc	7	Constru	7
561990	All Other Support Services	R/A's of America	3	Other	3
541219	Other Accounting Services	Soaring Eagles of Gardnerville	1	Office_P	1
541219	Other Accounting Services	Integrity Business Solutions	7	Office_P	7
814110	Private Households	Nicole A Tradup	3	Other	3
721110	Hotels (except Casino Hotels) and Motels	Sierra Motel	3	Hotel_NG	3
541511	Custom Computer Programming Services	Integrated Transportation Info	3	Office_P	3
624410	Child Day Care Services	Main Street Preschool LLC	7	Other	7
453110	Florists	A Wild Flower	3	Retail	3
453220	Gift, Novelty, and Souvenir Stores	Joyces Jewelry Gifts & Antiq	7	Retail	7
511110	Newspaper Publishers	Record Courier	1	Office_P	1
511110	Newspaper Publishers	Record Courier	7	Office_P	7
541820	Public Relations Agencies	Sierra Specialized	3	Office_P	3
812112	Beauty Salons	Delicate Definitions Inc	3	Retail	3
621420	Outpatient Mental Health Centers	Public and Behavioral Health	15	Medical	15
624120	Services for the Elderly and Disabled	Aging and Disability Services	3	Other	3
238991	All Other Residential Trade Constructors	Colbre Grading & Paving of NV	7	Constru	7
425120	Wholesale Trade Agents and Brokers	Premier Sales & Marketing Inc	3	Other	3
624410	Child Day Care Services	Urban Jungle	1	Other	1
445120	Convenience Stores	Sierra Market	3	Retail	3
522291	Consumer Lending	Quik Chek Inc	3	Office_P	3
621310	Offices of Chiropractors	David J Trujillo DC Ltd	3	Medical	3
541191	Title Abstract and Settlement Offices	Western Title Company LLC	7	Office_P	7
621210	Offices of Dentists	Eric S Park DDS Pc	7	Medical	7
522120	Savings Institutions	El Dorado Savings Bank	15	Office_P	15
621111	Offices of Physicians, ex. Mental Health	Ralph D Herbig Do Ltd	1	Medical	1
522110	Commercial Banking	Wells Fargo Bank N A	25	Office_P	25
523930	Investment Advice	Wells Fargo Advisors LLC	3	Office_P	3
524210	Insurance Agencies and Brokerages	Warren W Reed Insurance Inc	15	Office_P	15

Douglas County/Carson City Regional Travel Demand Model

SIC_CODE	Industry	Trade_Name	Employment	Model_Category	Total_Emp
531320	Offices of Real Estate Appraisers	Allied Appraisers Limited Liab	1	Office_P	1
561920	Convention and Trade Show Organizers	Yourmeetingpro.Com	3	Office_P	3
522110	Commercial Banking	US Bank National Assoc	7	Office_P	7
115210	Support Activities for Animal Production	Cottonwood Creek LLC	3	Other	3
524210	Insurance Agencies and Brokerages	Mary Jane Lake Insurance	3	Office_P	3
722513	Limited-Service Restaurants	Pizza Barn	7	Food_Dr	7
712120	Historical Sites	Friends of Dangberg Home Ranch	3	Other	3
813319	Other Social Advocacy Organizations	Partnrshp of Community Resrcs	7	Office_P	7
812210	Funeral Homes and Funeral Services	Walton's Funerals & Cremations	3	Other	3
441228	Motorcycle, ATV, and All Other Motor Vehicle	NV West Motor Sports	1	Retail	1
811111	General Automotive Repair	Christensen Automotive of Gard	15	Retail	15
517110	Wired Telecommunications Carriers	Frontier Comm. of the Southwest	15	Office_P	15
454111	Electronic Shopping	Www.Get-Huge.Net	3	Retail	3
522130	Credit Unions	Greater Nevada Credit Union	7	Office_P	7
522292	Real Estate Credit	Greater Nevada Mortgage Services	3	Office_P	3
238991	All Other Residential Trade Constructors	Lancaster Construction Inc	3	Constru	3
524210	Insurance Agencies and Brokerages	J Mike Eddy Agency Inc	1	Office_P	1
524210	Insurance Agencies and Brokerages	American Family Insurance	3	Office_P	3
561720	Janatorial Services	Merry Maids #1138	15	Other	15
541310	Architechtrual Services	Muller Design Associates Inc	3	Office_P	3
541910	Marketing Research & Public Opinion Poll	Peter H Mattson & Co Inc	3	Office_P	3
811111	General Automotive Repair	One Stop Auto Repair	3	Retail	3
424710	Petroleum Bulk Stations and Terminals	Flyers Energy LLC	3	Ware_H	3
722515	Snack and Nonalcoholic Beverage Bars	Coffee on Main	7	Food_Dr	7
451110	Sporting Goods Stores	High Desert Guns	1	Retail	1
811490	Other Household Goods Repair/Maintenance	Testa Motorsports	7	Retail	7
523991	Trust, Fiduciary, and Custody Activities	Sierra Guardians LLC	3	Office_P	3
112111	Beef Cattle Ranching and Farming	Willow Stay Ranch	3	Other	3
236220	Commercial Building Construction	A&A Construction	15	Constru	15
524210	Insurance Agencies and Brokerages	Bill Heise Insurance Inc	1	Office_P	1
445120	Convenience Stores	J&M Mini Mart	3	Retail	3
812320	Drycleaning and Laundry Services	Bobby Pages Dry Cleaners &	3	Retail	3
423710	Hardware Merchant Wholesalers	Fastenal Co	3	Ware_H	3
541110	Offices of Lawyers	Nancy Rey Jackson Ltd	3	Office_P	3
814110	Private Households	Pamela B Pesenti	3	Other	3
722513	Limited-Service Restaurants	Minden Meat and Deli	15	Food_Dr	15

Douglas County/Carson City Regional Travel Demand Model

SIC_CODE	Industry	Trade_Name	Employment	Model_Category	Total_Emp
541330	Engineering Services	Building Concepts Inc	3	Office_P	3
541110	Offices of Lawyers	Greenberg Glusker Fields Clama	3	Office_P	3
236115	New Single-Family Housing Construction	Warren Company, The	3	Constru	3
531120	Lessors of Nonresidential Buildings	Hellwinkel Enterprises Inc	1	Office_P	1
722410	Drinking Places (Alcoholic Beverages)	Corner Bar LLC, The	3	Food_Dr	3
442299	All Other Home Furnishings Stores	Lone Tree Frame Company	1	Retail	1
722511	Full-Service Restaurants	Barone & Reed Food Company	15	Food_Dr	15
814110	Private Households	Henry A Schaffner Family Trust	3	Other	3
541330	Engineering Services	R O Anderson Engineering Inc	35	Office_P	35
238212	Nonresidential Electrical Contractors	Minden Electric LLC	1	Constru	1
611110	Elementary and Secondary Schools	Douglas County School District	950	School	950
442210	Floor Covering Stores	Summit Carpets	3	Retail	3
238391	Other Residential Finishing Contractors	Closet Masters of Nevada	3	Constru	3
814110	Private Households	Marjorie A Springmeyer	3	Other	3
238341	Residential Tile/Terrazzo Contractors	Pogo Tile & Stone Inc	3	Constru	3
541211	Offices of Certified Public Accountants	Neddenriep & Associates CPAs L	3	Office_P	3
713940	Fitness and Recreational Sports Centers	Carson Valley Swim Center	95	Other	95
713990	All Other Amusement and Recreation Ind	Douglas Dolphins Swim Team Inc	3	Other	3
238211	Residential Electrical Contractors	Hook and Sons Inc	3	Constru	3
722511	Full-Service Restaurants	Amerikan Ni	15	Food_Dr	15
561730	Landscaping Services	Designing With Nature Inc	15	Other	15
523930	Investment Advice	Michael C Mellows Investments	3	Office_P	3
541211	Offices of Certified Public Accountants	Bushnell & Associates	1	Office_P	1
561510	Travel Agencies	Cruisescape Travel	1	Office_P	1
921140	Executive & Legislative Offices Combined	Douglas County	650	Office_G	650
531210	Offices of Real Estate Agents & Brokers	Verus Realty	3	Office_P	3
236210	Industrial Building Construction	West Tec Construction Inc	3	Constru	3
333318	Other Commercial and Service Industry Machine	Aqua Sun International	3	Goods_P	3
541219	Other Accounting Services	Advantacare	7	Office_P	7
541330	Engineering Services	Rockland Engineered Solutions	3	Office_P	3
541620	Environmental Consulting Services	Copper Environmental Consultin	3	Office_P	3
541690	Other Technical Consulting Services	Techno Consulting	1	Office_P	1
611610	Fine Arts Schools	All About Dance Inc	15	School	15
522292	Real Estate Credit	Acceptance Capital Mortgage	3	Office_P	3
531210	Offices of Real Estate Agents & Brokers	M Scott Properties Inc	7	Office_P	7
722511	Full-Service Restaurants	Salettis Restaurant and Bar	35	Food_Dr	35

Douglas County/Carson City Regional Travel Demand Model

SIC_CODE	Industry	Trade_Name	Employment	Model_Category	Total_Emp
522320	Financial Transaction Process/Clearing	Devron Enterprises Inc	3	Office_P	3
621111	Offices of Physicians, ex. Mental Health	David A Johnson MD	3	Medical	3
511120	Periodical Publishers	Sierra Scoop	3	Office_P	3
541110	Offices of Lawyers	Rowe Hales Yturbide LLP	3	Office_P	3
621210	Offices of Dentists	Minden Dental	7	Medical	7
236115	New Single-Family Housing Construction	Tahoe Timbers & Millworks	3	Constru	3
541110	Offices of Lawyers	Law Office of Karen L Winters	3	Office_P	3
561730	Landscaping Services	Christine Fixman Landscaping	7	Other	7
541320	Landscape Architechtural Services	Sandra Wendel Landscape Archit	1	Office_P	1
621111	Offices of Physicians, ex. Mental Health	Minden Dermatology	3	Medical	3
237310	Highway, Street, and Bridge Construction	Qualcon Contractors Inc	15	Constru	15
924120	Administration of Conservation Programs	Forest Service	25	Office_G	25
924120	Administration of Conservation Programs	Carson Valley Conservation Dis	3	Office_G	3
561730	Landscaping Services	Carson Valley Conservaton District	7	Other	7
621111	Offices of Physicians, ex. Mental Health	Gerald L Cottrell MD	3	Medical	3
621210	Offices of Dentists	Parigini Orthodontics Inc	15	Medical	15
813319	Other Social Advocacy Organizations	Suicide Prevention Network Ltd	3	Office_P	3
621210	Offices of Dentists	Celeste M Eckerman DDS LLC	15	Medical	15
713940	Fitness and Recreational Sports Centers	Pulse Fitness	25	Other	25
238351	Residential Finish Carpentry Contractors	Michael W Rohrer Construction	7	Constru	7
523120	Securities Brokerage	Jeff L Whitaker CFP	3	Office_P	3
531312	Nonresidential Property Managers	R.H.Brown II Company Inc	3	Office_P	3
551114	Managing Offices	Advanced Particle Therapy LLC	3	Office_P	3
621210	Offices of Dentists	Mark Allen DDS	3	Medical	3
621210	Offices of Dentists	Valley Pediatric Dentistry	15	Medical	15
621320	Offices of Optometrists	Pritchett Eye Care	7	Medical	7
621340	Offices of Specialty Therapists	Great Basin Physical Therapy A	7	Medical	7
523930	Investment Advice	Trunorth Wealth Management LLC	3	Office_P	3
541110	Offices of Lawyers	Kelly R Chase	3	Office_P	3
621210	Offices of Dentists	Jay D Marriage DDS	7	Medical	7
551114	Managing Offices	G Peg li	15	Office_P	15
721120	Casino Hotels	Carson Valley Inn	350	Hotel_G	350
621310	Offices of Chiropractors	Stuart F Pardee DC	3	Medical	3
425120	Wholesale Trade Agents and Brokers	Digital Financial Group	3	Other	3
523930	Investment Advice	Brady & Associates	3	Office_P	3
524210	Insurance Agencies and Brokerages	20 Mile Insurance Services	3	Office_P	3

Douglas County/Carson City Regional Travel Demand Model

SIC_CODE	Industry	Trade_Name	Employment	Model_Category	Total_Emp
541110	Offices of Lawyers	Sullivan Law	7	Office_P	7
551114	Managing Offices	Perennial Vacation Club	15	Office_P	15
561110	Office Administrative Services	Mobius Advisors LLC	3	Office_P	3
621210	Offices of Dentists	Timothy R Stoll DDS	7	Medical	7
621210	Offices of Dentists	Gary D Anderson DDS Inc	15	Medical	15
621340	Offices of Specialty Therapists	Physical Therapy Specialist LI	3	Medical	3
621511	Medical Laboratories	Laboratory Corp of America	3	Medical	3
611610	Fine Arts Schools	Dance Workshop Performing Arts	3	School	3
541110	Offices of Lawyers	George M Keele A Prof Corp	3	Office_P	3
541330	Engineering Services	SunEdison	3	Office_P	3
491110	Postal Service	USPS Minden	15	Other	15
334513	Industrial Process Variable Instruments	Bently Nevada Inc	55	Goods_P	55
334513	Industrial Process Variable Instruments	Bently Nevada	650	Goods_P	650
336413	Other Aircraft Parts and Equipment	GE Engine Services	65	Goods_P	65
423620	Electric Appliance Merchant Wholesalers	General Electric	7	Ware_H	7
541219	Other Accounting Services	GE Energy Management Services Inc	3	Office_P	3
541330	Engineering Services	GE Energy Control Solutions In	3	Office_P	3
541330	Engineering Services	Quest Global Service-NA Inc	7	Office_P	7
541330	Engineering Services	GE Oil & Gas Inc	7	Office_P	7
541512	Computer Systems Design Services	Logic Technology Inc	3	Office_P	3
541512	Computer Systems Design Services	GE Energy Power Conversion USA	3	Office_P	3
541990	All Other Professional & Technical Svc	Ferguson Enterprises	3	Office_P	3
551114	Managing Offices	Dresser Inc	3	Office_P	3
551114	Managing Offices	GE Infrastructure Sensing	3	Office_P	3
621111	Offices of Physicians, ex. Mental Health	Healthworks Medical Group of NV	3	Medical	3
621399	Offices of Misc Health Practitioners	Take Care Health Systems	3	Medical	3
722310	Food Service Contractors	Ge Energy - Minden Nevada	25	Food_Dr	25
999999	Unknown Industry	Reuter Stokes	3	Other	3
531210	Offices of Real Estate Agents & Brokers	Chase International	3	Office_P	3
722511	Full-Service Restaurants	Tahoe Ridge Winery & Mkt Place	25	Food_Dr	25
522110	Commercial Banking	Bank of America	15	Office_P	15
523120	Securities Brokerage	Wells Fargo Advisors LLC	7	Office_P	7
447110	Gasoline Stations w/ Convenience Stores	Maverik Country Stores, Inc	15	Retail	15
236115	New Single-Family Housing Construction	H & S Construction Inc	15	Constru	15
531110	Lessors of Residential Buildings	Harris Homes Inc	3	Office_P	3
541219	Other Accounting Services	Coleman Caine & Matzinger & Co	3	Office_P	3

Douglas County/Carson City Regional Travel Demand Model

SIC_CODE	Industry	Trade_Name	Employment	Model_Category	Total_Emp
621340	Offices of Specialty Therapists	Sierra Physical Therapy	3	Medical	3
522110	Commercial Banking	City National Bank	3	Office_P	3
721110	Hotels (except Casino Hotels) and Motels	Holiday Inn Express-Minden	15	Hotel_NG	15
522110	Commercial Banking	Nevada State Bank	15	Office_P	15
522310	Mortgage and Nonmortgage Loan Brokers	Northstar Lending Group Inc	3	Office_P	3
621111	Offices of Physicians, ex. Mental Health	Carson Valley Medical Center	15	Medical	15
621391	Offices of Podiatrists	Carson Valley Foot Care	3	Medical	3
812199	Other Personal Care Services	Sunsational Tanning	1	Retail	1
522320	Financial Transaction Process/Clearing	J & S Merchant Solutions	3	Office_P	3
524210	Insurance Agencies and Brokerages	Ferguson Leavitt Insur Agency	3	Office_P	3
541110	Offices of Lawyers	Rachelle J Nicolle Ltd	1	Office_P	1
541620	Environmental Consulting Services	C G Celio & Sons Co	3	Office_P	3
541620	Environmental Consulting Services	Native American Water Associat	3	Office_P	3
561320	Temporary Help Services	Valley Staffing Solutions	35	Office_P	35
812112	Beauty Salons	Taylor York Salon	7	Retail	7
524210	Insurance Agencies and Brokerages	J & M Lewis Inc	3	Office_P	3
524210	Insurance Agencies and Brokerages	Rhonda L Moore Insurance Agency	3	Office_P	3
524210	Insurance Agencies and Brokerages	Sean Marler Insurance Agency I	3	Office_P	3
524210	Insurance Agencies and Brokerages	Stockmens Insurance Inc	3	Office_P	3
524210	Insurance Agencies and Brokerages	Langlands & Associates Inc	3	Office_P	3
531311	Residential Property Managers	New Valley Real Estate Mgmt Inc	7	Office_P	7
621111	Offices of Physicians, ex. Mental Health	Carson Valley Family Health Ce	7	Medical	7
621210	Offices of Dentists	Thomas Unruh DDS PC	7	Medical	7
621210	Offices of Dentists	Dr James The Dentist	15	Medical	15
621320	Offices of Optometrists	Valley Eyecare & Eyewear Galle	7	Medical	7
453998	Store Retailers Not Specified Elsewhere	Pioneer Yarn Company LLC	3	Retail	3
621310	Offices of Chiropractors	Bohner Chiropractic	3	Medical	3
541211	Offices of Certified Public Accountants	Carson Valley Accounting LLC	7	Office_P	7
722513	Limited-Service Restaurants	Mcdonald's	45	Food_Dr	45
812112	Beauty Salons	Drago Salon And Company	3	Retail	3
722513	Limited-Service Restaurants	Super Burrito	7	Food_Dr	7
425120	Wholesale Trade Agents and Brokers	Spectral Dynamics Inc	3	Other	3
524210	Insurance Agencies and Brokerages	Carson Valley Insurance	3	Office_P	3
531210	Offices of Real Estate Agents & Brokers	Century 21-Clark Properties In	3	Office_P	3
531311	Residential Property Managers	Property Mgmt & Maint Llc	3	Office_P	3
541191	Title Abstract and Settlement Offices	First American Title Insurance Comp	3	Office_P	3

Douglas County/Carson City Regional Travel Demand Model

SIC_CODE	Industry	Trade_Name	Employment	Model_Category	Total_Emp
541219	Other Accounting Services	A&H Billing Specialties Inc	3	Office_P	3
624410	Child Day Care Services	Allie & Friends Infant And Tod	15	Other	15
621111	Offices of Physicians, ex. Mental Health	Sanchez Adult Medical Care	7	Medical	7
721110	Hotels (except Casino Hotels) and Motels	Perennial Vacation Club	7	Hotel_NG	7
811192	Car Washes	Melvins Car Wash & Detail	7	Retail	7
532291	Home Health Equipment Rental	Lincare Inc	7	Other	7
541110	Offices of Lawyers	J M Clouser & Associates Ltd	1	Office_P	1
447110	Gasoline Stations w/ Convenience Stores	Arco AM/PM 82386	7	Retail	7
722511	Full-Service Restaurants	Cowboys Cafe	7	Food_Dr	7
621111	Offices of Physicians, ex. Mental Health	Carson Valley Medical Center	3	Medical	3
621340	Offices of Specialty Therapists	Bodywise Physical Therapy	15	Medical	15
722513	Limited-Service Restaurants	Subway	15	Food_Dr	15
323111	Commercial Gravure Printing	ABE Printing & Copy	3	Goods_P	3
722511	Full-Service Restaurants	Wild Horse Bar & Grill, The	15	Food_Dr	15
511210	Software Publishers	Sum-Ware Inc	3	Office_P	3
522320	Financial Transaction Process/Clearing	Echo Daily Inc	15	Office_P	15
531210	Offices of Real Estate Agents & Brokers	Calneva Realty	3	Office_P	3
551114	Managing Offices	Harrahs Lake Tahoe	3	Office_P	3
112111	Beef Cattle Ranching and Farming	Pope Valley Ranching Nevada LI	3	Other	3
448120	Women's Clothing Stores	Promenade Deck	7	Retail	7
484230	Other Specialized Trucking, Long-Dist	Hertz Corp	3	Other	3
532111	Passenger Car Rental	Hertz Corp	3	Other	3
541921	Photography Studios, Portrait	Advanced Video	1	Office_P	1
561720	Janatorial Services	Full Service Systems Corp	250	Other	250
561920	Convention and Trade Show Organizers	Encore Event Technologies Inc	3	Office_P	3
621111	Offices of Physicians, ex. Mental Health	Healthworks Medical Group of Nv	7	Medical	7
621111	Offices of Physicians, ex. Mental Health	Take Care Health Systems	15	Medical	15
721120	Casino Hotels	Harrah's Stateline	1250	Hotel_G	1250
722513	Limited-Service Restaurants	Asian Grill Express	7	Food_Dr	7
812112	Beauty Salons	Lu Lu	15	Retail	15
541191	Title Abstract and Settlement Offices	First American Title Insurance Comp	3	Office_P	3
454111	Electronic Shopping	Energy Drink Outlet, The	1	Retail	1
523120	Securities Brokerage	Jones, Edward D & Company	3	Office_P	3
722513	Limited-Service Restaurants	Fat Burger	25	Food_Dr	25
624120	Services for the Elderly and Disabled	Monika Abbott	3	Other	3
561740	Carpet and Upholstery Cleaning Services	Servpro of Carson City Douglas	3	Other	3

Douglas County/Carson City Regional Travel Demand Model

SIC_CODE	Industry	Trade_Name	Employment	Model_Category	Total_Emp
561920	Convention and Trade Show Organizers	Audio Visual Services Group	3	Office_P	3
721120	Casino Hotels	Harvey's Resort Hotel Casino	650	Hotel_G	650
722511	Full-Service Restaurants	Hard Rock Cafe #1167	75	Food_Dr	75
722513	Limited-Service Restaurants	Straw Hat Pizza Harveys Casino	3	Food_Dr	3
722515	Snack and Nonalcoholic Beverage Bars	Cinnabon	3	Food_Dr	3
524210	Insurance Agencies and Brokerages	American Family/Mark Smith	3	Office_P	3
541110	Offices of Lawyers	Brooke Shaw Zumpft	3	Office_P	3
531210	Offices of Real Estate Agents & Brokers	Resort Investment Capital	35	Office_P	35
721110	Hotels (except Casino Hotels) and Motels	Ridge Resorts / Resorts West	250	Hotel_NG	250
722410	Drinking Places (Alcoholic Beverages)	X Hale Hookah Bar Lounge	15	Food_Dr	15
813990	Other Similar Organizations	Ridge Pointe Prop Owners Assn	3	Office_P	3
722513	Limited-Service Restaurants	Dairy Queen Minden	15	Food_Dr	15
451110	Sporting Goods Stores	Summit Sports	3	Retail	3
487110	Scenic/Sightseeing Transportation, Land	Borges Sleigh & Carriage Rides	3	Other	3
512131	Motion Picture Theaters, ex. Drive-Ins	Horizon Stadium 8	1	Other	1
721120	Casino Hotels	Lake Tahoe Horizon Casino	1	Hotel_G	1
721120	Casino Hotels	Tahoe Horizon	1	Hotel_G	1
721120	Casino Hotels	Hard Rock Hotel & Casino Lake Tahoe	7	Hotel_G	7
446110	Pharmacies and Drug Stores	CVS/Pharmacy	15	Retail	15
448120	Women's Clothing Stores	Teaz n Pleaz	3	Retail	3
713290	Other Gambling Industries	Dotty's	7	Other	7
722515	Snack and Nonalcoholic Beverage Bars	Starbucks Coffee	15	Food_Dr	15
111940	Hay Farming	Park Ranch	7	Other	7
551114	Managing Offices	Park Heritage	3	Office_P	3
325199	All Other Basic Organic Chemicals	Bently Biofuels Company LLC	15	Goods_P	15
813990	Other Similar Organizations	Ridge Crest Prop Owners Assn	3	Office_P	3
524210	Insurance Agencies and Brokerages	Zenefits FTW Insurance Service	3	Office_P	3
812220	Cemeteries and Crematories	Eastside Memorial Park Inc	3	Other	3
531120	Lessors of Nonresidential Buildings	Bently Enterprises LLC	45	Office_P	45
551114	Managing Offices	CCDM LLC	1	Office_P	1
813990	Other Similar Organizations	Ridge Tahoe Prop Owners Assn	3	Office_P	3
713920	Skiing Facilities	Heavenly Valley Ltd Ptrship	55	Other	55
532490	Other Machinery Rental and Leasing	Sierra View Equipment Inc	15	Other	15
541213	Tax Preparation Services	H & R Block	1	Office_P	1
722511	Full-Service Restaurants	La Hacienda Del Sazon Mexican	3	Food_Dr	3
722513	Limited-Service Restaurants	Minden Pizza Factory	1	Food_Dr	1

Douglas County/Carson City Regional Travel Demand Model

SIC_CODE	Industry	Trade_Name	Employment	Model_Category	Total_Emp
722513	Limited-Service Restaurants	Pizza Factory Minden	15	Food_Dr	15
812112	Beauty Salons	Cost Cutters	7	Retail	7
721110	Hotels (except Casino Hotels) and Motels	Tahoe Summit Village Timeshare	15	Hotel_NG	15
512131	Motion Picture Theaters, ex. Drive-Ins	Ironwood 8 Cinemas	15	Other	15
713910	Golf Courses and Country Clubs	Edgewood Tahoe Golf Course	250	Other	250
531311	Residential Property Managers	New Life Mult-Family Managemen	3	Office_P	3
811191	Automotive Oil Change/Lubrication Shops	Jiffy Lube	7	Retail	7
236118	Residential Remodelers	MKM Builders Inc	7	Constru	7
621111	Offices of Physicians, ex. Mental Health	VA Carson Valley Outpatient Clinic	15	Medical	15
621111	Offices of Physicians, ex. Mental Health	Carson Tahoe Cardiology, LLC	3	Medical	3
621111	Offices of Physicians, ex. Mental Health	Carson Medical Group	7	Medical	7
621111	Offices of Physicians, ex. Mental Health	Mountainview Med Associates	7	Medical	7
621111	Offices of Physicians, ex. Mental Health	Carson Tahoe Minden Medical Center	15	Medical	15
522110	Commercial Banking	Wells Fargo Bank N A	15	Office_P	15
448190	Other Clothing Stores	Sport Habitat	3	Retail	3
448190	Other Clothing Stores	Romantic Adventures	7	Retail	7
453220	Gift, Novelty, and Souvenir Stores	Paper & Gold Neighbors Booksto	3	Retail	3
453991	Tobacco Stores	Lake Tahoe Cigar Company Inc	3	Retail	3
713290	Other Gambling Industries	Mont Bleu Race & Sports Book	7	Other	7
721120	Casino Hotels	Montbleu Resort Casino and Spa	650	Hotel_G	650
443141	Household Appliance Stores	Martys Appliance	7	Retail	7
451110	Sporting Goods Stores	Big 5 Sporting Goods	15	Retail	15
452990	All Other General Merchandise Stores	Dollar Tree Store	15	Retail	15
425120	Wholesale Trade Agents and Brokers	Bay Products Incorporated	3	Other	3
332912	Fluid Power Valves and Hose Fittings	Maxton Manufacturing Company	35	Goods_P	35
531312	Nonresidential Property Managers	Vacation Resorts International	3	Office_P	3
721110	Hotels (except Casino Hotels) and Motels	Vacation Internationale Inc	7	Hotel_NG	7
541611	Administrative Management Consulting Svc	Biofilm Management Inc	15	Office_P	15
531210	Offices of Real Estate Agents & Brokers	Corporate Management Service	1	Office_P	1
551114	Managing Offices	Business Resource LLC	7	Office_P	7
621111	Offices of Physicians, ex. Mental Health	Carson Valley Medical Center	7	Medical	7
621210	Offices of Dentists	Jason Acevedo D.D.S LLC	7	Medical	7
722511	Full-Service Restaurants	Louies Mandarin Gourmet	3	Food_Dr	3
722511	Full-Service Restaurants	Buona Sera Ristorante & Bar	1	Food_Dr	1
721110	Hotels (except Casino Hotels) and Motels	Quality Inn & Suites - Minden	15	Hotel_NG	15
334513	Industrial Process Variable Instruments	Perma-Cal Industries Inc	25	Goods_P	25

Douglas County/Carson City Regional Travel Demand Model

SIC_CODE	Industry	Trade_Name	Employment	Model_Category	Total_Emp
541618	Other Management Consulting Services	Mccoys Power Consultants Inc	3	Office_P	3
813990	Other Similar Organizations	Royal Aloha Vacation Club	15	Office_P	15
334417	Electronic Connector Manufacturing	Cristek Interconnects Inc	15	Goods_P	15
624110	Child and Youth Services	Lorraine Vazquez	3	Other	3
541620	Environmental Consulting Services	Gordon Consulting Inc	3	Office_P	3
541320	Landscape Architectural Services	Model Builders Inc	1	Office_P	1
221320	Sewage Treatment Facilities	Minden-Gardnerville Sanitation	15	Goods_P	15
541611	Administrative Management Consulting Svc	M D Sheets Company	3	Office_P	3
425120	Wholesale Trade Agents and Brokers	Wellness Consultants Inc	3	Other	3
813990	Other Similar Organizations	Tahoe Village Homeowners Assn	3	Office_P	3
531312	Nonresidential Property Managers	Interval Management, Inc	7	Office_P	7
531110	Lessors of Residential Buildings	Fjeldheim Investments Inc	3	Office_P	3
423440	Other Commercial Equip Merchant Whsle	Neon Source / P O P Source	1	Ware_H	1
561730	Landscaping Services	Colorscape Inc	1	Other	1
523930	Investment Advice	Abacus Financial Services Ltd	3	Office_P	3
924110	Air, Water and Waste Program Admin	Environmental Protection Agency	3	Office_G	3
926120	Transportation Program Administration	Tahoe Transportation District	7	Office_G	7
541320	Landscape Architectural Services	Design Workshop Inc	7	Office_P	7
541620	Environmental Consulting Services	Ascent Environmental Inc	3	Office_P	3
813990	Other Similar Organizations	Ridge View Prop Owners Assn	3	Office_P	3
813110	Religious Organizations	Tahoe Community Church	15	Other	15
484220	Other Specialized Trucking, Local	Gary Derner Trucking Inc	7	Other	7
531311	Residential Property Managers	Kingsbury Crossing	15	Office_P	15
611430	Management Training	Anakam	1	School	1
561410	Document Preparation Services	Anbiid Llc	1	Office_P	1
541330	Engineering Services	Robert Kowalczyk Ltd LLC	3	Office_P	3
541519	Other Computer Related Services	MD Visuals	3	Office_P	3
541990	All Other Professional & Technical Svc	Wm Tom Rice Inc	1	Office_P	1
924120	Administration of Conservation Programs	Nevada Tahoe Conservation District	7	Office_G	7
339950	Sign Manufacturing	Dimensional Graphics Inc	3	Goods_P	3
425120	Wholesale Trade Agents and Brokers	La Caviar USA Inc	1	Other	1
454111	Electronic Shopping	Vitality Research Group Ltd	3	Retail	3
522310	Mortgage and Nonmortgage Loan Brokers	Paramount Equity Mortgage LLC	1	Office_P	1
523910	Miscellaneous Intermediation	Spearhead Capital Corporation	3	Office_P	3
541613	Marketing Consulting Services	2View.Com	1	Office_P	1
541690	Other Technical Consulting Services	JTV Nuclear Consultants	3	Office_P	3

Douglas County/Carson City Regional Travel Demand Model

SIC_CODE	Industry	Trade_Name	Employment	Model_Category	Total_Emp
551114	Managing Offices	Rapid External Solutions Inc	3	Office_P	3
561110	Office Administrative Services	Tahoe Business Management	3	Office_P	3
561510	Travel Agencies	Tahoe Worldwide Travel LLC	3	Office_P	3
812990	All Other Personal Services	Blue Sky Events & Destination	3	Other	3
999999	Unknown Industry	Enterprise Services Group	1	Other	1
238221	Residential Plumbing/HVAC Contractors	Wolfe Plumbing	7	Constru	7
451110	Sporting Goods Stores	Elevation 6225 Sports	3	Retail	3
523920	Portfolio Management	Force Capital Partners LLC	3	Office_P	3
531210	Offices of Real Estate Agents & Brokers	Emerald Realty Inc	3	Office_P	3
541110	Offices of Lawyers	Cristina M Hughes	3	Office_P	3
541810	Advertising Agencies	Grant Wolf Inc	7	Office_P	7
551114	Managing Offices	T&D Power Inc	3	Office_P	3
722513	Limited-Service Restaurants	Luigis Tahoe Pizzeria	3	Food_Dr	3
812310	Coin-Operated Laundries and Drycleaners	Kingsbury Coin Laundry	3	Retail	3
236118	Residential Remodelers	Frederick Luyties	3	Constru	3
522310	Mortgage and Nonmortgage Loan Brokers	Washburn Real Estate Services	3	Office_P	3
532292	Recreational Goods Rental	Black Tie Ski Rentals of South	1	Other	1
541211	Offices of Certified Public Accountants	Bruce L Cable CPA	3	Office_P	3
541921	Photography Studios, Portrait	Lake Tahoe Studio	1	Office_P	1
561422	Telemarketing Bureaus	ISI	7	Office_P	7
541511	Custom Computer Programming Services	DM Software Inc	3	Office_P	3
722511	Full-Service Restaurants	Thai One On	3	Food_Dr	3
621111	Offices of Physicians, ex. Mental Health	Tahoe Carson Valley Medical Gr	7	Medical	7
621340	Offices of Specialty Therapists	Barton Healthcare Services	3	Medical	3
621493	Freestanding Emergency Medical Centers	Stateline Medical Center	35	Medical	35
238211	Residential Electrical Contractors	Arctic Electricians	7	Constru	7
334513	Industrial Process Variable Instruments	Applied Vibration Systems Inc	3	Goods_P	3
522291	Consumer Lending	USA Cash Services	3	Office_P	3
541110	Offices of Lawyers	Jeffrey K Rahbeck	3	Office_P	3
722410	Drinking Places (Alcoholic Beverages)	Goalpost, The	7	Food_Dr	7
722511	Full-Service Restaurants	Mirabelle Restaurant	3	Food_Dr	3
812910	Pet Care (except Veterinary) Services	Tahoe Tails and Trails	1	Retail	1
517110	Wired Telecommunications Carriers	Frontier Comm. of the Southwest	3	Office_P	3
712190	Nature Parks & Other Similar Institution	Parks Division	7	Other	7
425120	Wholesale Trade Agents and Brokers	Teadit Na Inc	3	Other	3
541110	Offices of Lawyers	Julie Bachman A Law Corporatio	3	Office_P	3

Douglas County/Carson City Regional Travel Demand Model

SIC_CODE	Industry	Trade_Name	Employment	Model_Category	Total_Emp
541380	Testing Laboratories	Nano-Lux	3	Office_P	3
541611	Administrative Management Consulting Svc	Source 14 Platforms Inc	3	Office_P	3
541820	Public Relations Agencies	Weidinger Public Relations	3	Office_P	3
561720	Janatorial Services	All Clean Windows & Snow Remov	3	Other	3
561720	Janatorial Services	Scott Hoppe	3	Other	3
814110	Private Households	CNH LLC	3	Other	3
447110	Gasoline Stations w/ Convenience Stores	Michelsens Gas-A-Mart	7	Retail	7
522310	Mortgage and Nonmortgage Loan Brokers	Z Loan & Investment LLC	3	Office_P	3
531210	Offices of Real Estate Agents & Brokers	Milanco Ltd	3	Office_P	3
236115	New Single-Family Housing Construction	Gardner Enterprises LLC	15	Constru	15
541330	Engineering Services	Lumos & Associates, Inc	3	Office_P	3
522110	Commercial Banking	US Bank National Assoc	15	Office_P	15
722511	Full-Service Restaurants	Red Hut Cafe	15	Food_Dr	15
451110	Sporting Goods Stores	Shoreline of Tahoe	7	Retail	7
722511	Full-Service Restaurants	Mott Canyon Tavern & Grill	15	Food_Dr	15
541611	Administrative Management Consulting Svc	Lemed Inc	3	Office_P	3
531311	Residential Property Managers	Lake Tahoe Accommodations	7	Office_P	7
236118	Residential Remodelers	WPJ Development Inc	3	Constru	3
541690	Other Technical Consulting Services	Jurix Inc	1	Office_P	1
551114	Managing Offices	Prim Ventures Inc	15	Office_P	15
812990	All Other Personal Services	Smarte Carte	1	Other	1
451110	Sporting Goods Stores	Heavenly Sports	15	Retail	15
444130	Hardware Stores	Kingsbury Hardware	7	Retail	7
447110	Gasoline Stations w/ Convenience Stores	7-Eleven	7	Retail	7
524291	Claims Adjusting	John S Rickerby Company	3	Office_P	3
531130	Miniwarehouses and Self-Storage Unit	Kingsbury Self Storage LLC	3	Office_P	3
522110	Commercial Banking	Bank of America	3	Office_P	3
523120	Securities Brokerage	Morgan Stanley Smith Barney LLC	7	Office_P	7
524210	Insurance Agencies and Brokerages	Erik Watada State Farm Agency	3	Office_P	3
531210	Offices of Real Estate Agents & Brokers	Trish Hall Realty Inc	1	Office_P	1
541110	Offices of Lawyers	Alling & Jillson Ltd	7	Office_P	7
541191	Title Abstract and Settlement Offices	First American Title Insurance Comp	3	Office_P	3
541219	Other Accounting Services	Up & Running Inc	1	Office_P	1
541320	Landscape Architechtural Services	Wells Barnett Associates LLC	7	Office_P	7
561320	Temporary Help Services	Blue Ribbon Personnel Services	7	Office_P	7
561730	Landscaping Services	Sunset Systems Inc	3	Other	3

Douglas County/Carson City Regional Travel Demand Model

SIC_CODE	Industry	Trade_Name	Employment	Model_Category	Total_Emp
561730	Landscaping Services	Sunbasin Landscape & Nursery	15	Other	15
621111	Offices of Physicians, ex. Mental Health	Advanced Cosmetic Surgery/Dermatol.	25	Medical	25
621210	Offices of Dentists	Dennis D Bowman DDS	7	Medical	7
621320	Offices of Optometrists	Eyezone	3	Medical	3
624310	Vocational Rehabilitation Services	Peter Harrison Careers LLC	3	Other	3
445120	Convenience Stores	Dart Beverage	1	Retail	1
445120	Convenience Stores	Dart Beverage Center	7	Retail	7
541330	Engineering Services	Piermont Industries Inc	3	Office_P	3
531120	Lessors of Nonresidential Buildings	Cecils Market Inc	3	Office_P	3
221310	Water Supply and Irrigation Systems	Kingsbury Gen Improvement Dist	15	Goods_P	15
561790	Other Services to Buildings & Dwellings	KSR	1	Other	1
524210	Insurance Agencies and Brokerages	Insurance From A to Z	3	Office_P	3
722320	Caterers	Bella Tahoe Catering	7	Food_Dr	7
311352	Confectionery Manufacturing from Purchased Ch	Lake Tahoe Chocolate Factory	3	Goods_P	3
424720	Other Petroleum Merchant Wholesalers	Associated Energy Group LLC	7	Ware_H	7
424720	Other Petroleum Merchant Wholesalers	Associated Energy Group LLC	7	Ware_H	7
551114	Managing Offices	Mercfuel Inc	3	Office_P	3
621111	Offices of Physicians, ex. Mental Health	Cosmetic Dermatology by Sean	3	Medical	3
722511	Full-Service Restaurants	Chart House, The	75	Food_Dr	75
561591	Convention and Visitors Bureaus	Lake Tahoe Visitors Authority	7	Office_P	7
813910	Business Associations	Lake Tahoe So Shore Chamber of	7	Office_P	7
238151	Residential Glass/Glazing Contractors	Lakeside Glass Company	7	Constru	7
451130	Sewing, Needlework & Piece Goods Stores	Fabrics Unlimited	1	Retail	1
453998	Store Retailers Not Specified Elsewhere	Great American Wreath & Pineco	1	Retail	1
453920	Art Dealers	A Frame of Mind	1	Retail	1
561720	Janatorial Services	Economy Window Cleaners	3	Other	3
423610	Wiring & Equipment Merchant Wholesalers	Wedco, Inc.	3	Ware_H	3
811111	General Automotive Repair	Kingsbury Automotive	7	Retail	7
561410	Document Preparation Services	South Shore Capital LLC	7	Office_P	7
236118	Residential Remodelers	Tahoe Sierra Builders LLC	15	Constru	15
236118	Residential Remodelers	Quality Craftsman Construction	7	Constru	7
541611	Administrative Management Consulting Svc	GPD Corp	3	Office_P	3
721120	Casino Hotels	Lakeside Inn & Casino	350	Hotel_G	350
541511	Custom Computer Programming Services	Architected Solutions Inc	3	Office_P	3
711130	Musical Groups and Artists	D.M.Z Inc	3	Other	3
611420	Computer Training	Global Knowledge	1	School	1

Douglas County/Carson City Regional Travel Demand Model

SIC_CODE	Industry	Trade_Name	Employment	Model_Category	Total_Emp
512240	Sound Recording Studios	Heavenly Tracks LLC	3	Office_P	3
541519	Other Computer Related Services	Deshtech Solutions Inc	3	Office_P	3
541611	Administrative Management Consulting Svc	American Svc Solutions Inc	3	Office_P	3
722410	Drinking Places (Alcoholic Beverages)	Fox & Hound	15	Food_Dr	15
445120	Convenience Stores	Tramway Market LLC	3	Retail	3
518210	Data Processing and Related Services	Infostream Group Inc	25	Office_P	25
236115	New Single-Family Housing Construction	A Level Above	3	Constru	3
541219	Other Accounting Services	Affordable Business Services	3	Office_P	3
541712	Research and Development in the Physical, Eng	RC Electronics Inc	3	Office_P	3
624410	Child Day Care Services	Bright Beginnings Inc	3	Other	3
238221	Residential Plumbing/HVAC Contractors	Mountain Plumbing and Drain Cl	3	Constru	3
511130	Book Publishers	Moving Books Inc	1	Office_P	1
522292	Real Estate Credit	Equitable Enterprises Inc	1	Office_P	1
541110	Offices of Lawyers	Law Offices of William Cole	3	Office_P	3
541512	Computer Systems Design Services	Empirix Inc	3	Office_P	3
541611	Administrative Management Consulting Svc	Nevada Integrated Technology C	1	Office_P	1
541690	Other Technical Consulting Services	Lafayette Group Inc	3	Office_P	3
561431	Private Mail Centers	UPS Store #3955, The	3	Office_P	3
561920	Convention and Trade Show Organizers	Destination Tahoe Meetings & Events	15	Office_P	15
722511	Full-Service Restaurants	Little Philly Cheesesteaks LLC	7	Food_Dr	7
999999	Unknown Industry	Shared Care Research Inc	3	Other	3
541620	Environmental Consulting Services	MH3 Corporation	1	Office_P	1
722511	Full-Service Restaurants	Sul Lago Ristorante	1	Food_Dr	1
722511	Full-Service Restaurants	Sushi Pier Tahoe	25	Food_Dr	25
236115	New Single-Family Housing Construction	Ryan Brown Construction LLC	3	Constru	3
238911	Residential Site Preparation Contractors	F&B Inc	25	Constru	25
531120	Lessors of Nonresidential Buildings	Donald T Hall & Peggy Hall Trust	3	Office_P	3
561720	Janatorial Services	Lalas Cleaning Services Angeli	1	Other	1
511130	Book Publishers	Institute for Options Research	1	Office_P	1
425120	Wholesale Trade Agents and Brokers	In Motion Technology USA In	1	Other	1
425120	Wholesale Trade Agents and Brokers	In Motion Technology	3	Other	3
551114	Managing Offices	Wallace Theaters Mngmt Corp	3	Office_P	3
541213	Tax Preparation Services	Mitchell Financial Services	3	Office_P	3
522292	Real Estate Credit	Capital Mortgage Services Of T	1	Office_P	1
238131	Residential Framing Contractors	Designs in Wood	1	Constru	1
541512	Computer Systems Design Services	Sierra I.T. Group	3	Office_P	3

Douglas County/Carson City Regional Travel Demand Model

SIC_CODE	Industry	Trade_Name	Employment	Model_Category	Total_Emp
721110	Hotels (except Casino Hotels) and Motels	Wyndham Vacation Ownership	25	Hotel_NG	25
523920	Portfolio Management	Niemann Analytics Inc	1	Office_P	1
531210	Offices of Real Estate Agents & Brokers	Dos Hernans	3	Office_P	3
541840	Media Representatives	Motive Interactive Inc	3	Office_P	3
813211	Grantmaking Foundations	Point Foundation, The	3	Other	3
541512	Computer Systems Design Services	Dearborn Advisors LLC	1	Office_P	1
813990	Other Similar Organizations	Summit Village Inc	3	Office_P	3
541618	Other Management Consulting Services	Midkiff & Associates Inc	7	Office_P	7
238321	Residential Painting Contractors	Elements Painting	3	Constru	3
541940	Veterinary Services	Tahoe Star Veterinary Services	3	Office_P	3
236118	Residential Remodelers	Tahoe Homes Construction	1	Constru	1
722511	Full-Service Restaurants	Lucky Beaver Bar & Burger	35	Food_Dr	35
813990	Other Similar Organizations	Trinity & Associates	3	Office_P	3
711510	Independent Artists/Writers/Performers	East Peak Pictures Inc	1	Other	1
111940	Hay Farming	Bently Agrowdynamics	35	Other	35
541512	Computer Systems Design Services	Techtastic Fantastic Technicians	3	Office_P	3
541110	Offices of Lawyers	Rollston Henderson Crabb & Joh	3	Office_P	3
561311	Employment Placement Agencies	Advancededge Consulting Inc	3	Office_P	3
561730	Landscaping Services	Codys Tree Service	7	Other	7
423610	Wiring & Equipment Merchant Wholesalers	Upswung Corp	3	Ware_H	3
424990	Other Nondurable Goods Merchant Whsle	Gaming International	3	Ware_H	3
541511	Custom Computer Programming Services	Tin Foil Labs Inc	1	Office_P	1
561720	Janatorial Services	Tahoe Total Home Care, LLC	15	Other	15
541512	Computer Systems Design Services	Tahoe Technology Solutions	1	Office_P	1
236118	Residential Remodelers	Hurley Construction	1	Constru	1
236118	Residential Remodelers	CCS Homes	7	Constru	7
541620	Environmental Consulting Services	Hauge Brueck Associates Llc	3	Office_P	3
491110	Postal Service	USPS Zephyr Cove	7	Other	7
221320	Sewage Treatment Facilities	Tahoe-Douglas District	7	Goods_P	7
523120	Securities Brokerage	First Allied Securities	3	Office_P	3
531110	Lessors of Residential Buildings	Pine Rock LLC	3	Office_P	3
531210	Offices of Real Estate Agents & Brokers	Chase International	3	Office_P	3
711510	Independent Artists/Writers/Performers	PR Entertainment Inc	3	Other	3
541611	Administrative Management Consulting Svc	Snow Removal Consulting Grp In	1	Office_P	1
541611	Administrative Management Consulting Svc	Chandra Capital	1	Office_P	1
721110	Hotels (except Casino Hotels) and Motels	Almost Home Lodging Inc	3	Hotel_NG	3

Douglas County/Carson City Regional Travel Demand Model

SIC_CODE	Industry	Trade_Name	Employment	Model_Category	Total_Emp
925120	Urban and Rural Development Admin	Tahoe Regional Planning Agency	65	Office_G	65
424420	Packaged Frozen Food Merchant Whsle	Pilot Brands	7	Ware_H	7
533110	Lessors, Nonfinancial Intangible Assets	Virnetx Inc	7	Office_P	7
541211	Offices of Certified Public Accountants	David & Johnson Ltd	7	Office_P	7
541370	Other Surveying and Mapping Services	Turner & Associates Inc	3	Office_P	3
621210	Offices of Dentists	Richard Lusby DDS	7	Medical	7
541511	Custom Computer Programming Services	Informa Investment Solutions I	35	Office_P	35
531210	Offices of Real Estate Agents & Brokers	Chase International	3	Office_P	3
531390	Other Activities Related to Real Estate	TSI Title and Escrow Inc	3	Office_P	3
541211	Offices of Certified Public Accountants	RGCPA	3	Office_P	3
541310	Architechtrual Services	Between Silence & Light Inc	3	Office_P	3
541512	Computer Systems Design Services	Zaptech Corporation	3	Office_P	3
541519	Other Computer Related Services	High Sierra Financial	3	Office_P	3
443142	Electronics Stores	Sight and Sound Technologies	7	Retail	7
493110	General Warehousing and Storage	2 Dogs & a Cat	1	Ware_H	1
541940	Veterinary Services	Roundhill Animal Hosp	3	Office_P	3
238152	Nonresidential Glass/Glazing Contractors	Glass Doctor of the Sierras	3	Constru	3
236118	Residential Remodelers	Skyland Poe LLC	7	Constru	7
238211	Residential Electrical Contractors	Barstad Electric Inc	3	Constru	3
425120	Wholesale Trade Agents and Brokers	Softel Technologies LLC	3	Other	3
561990	All Other Support Services	Corporate Nevada Ltd	1	Other	1
561710	Exterminating and Pest Control Services	Carson Creature Catchers	3	Other	3
236115	New Single-Family Housing Construction	Ray Eberlin Construction	7	Constru	7
517110	Wired Telecommunications Carriers	Charter Communications	35	Office_P	35
531210	Offices of Real Estate Agents & Brokers	Tahoe Property Consultants LLC	3	Office_P	3
541110	Offices of Lawyers	Feldman McLaughlin Thiel LLP	3	Office_P	3
722511	Full-Service Restaurants	Capisce	15	Food_Dr	15
541110	Offices of Lawyers	Law Office Of Leslie J Shaw	3	Office_P	3
561720	Janatorial Services	Lake Tahoe Window Cleaning Llc	1	Other	1
721110	Hotels (except Casino Hotels) and Motels	Wyndham Vacation Ownership	150	Hotel_NG	150
541511	Custom Computer Programming Services	National Traffic Consultants I	3	Office_P	3
447110	Gasoline Stations w/ Convenience Stores	Lake Tahoe Oil Company	7	Retail	7
531210	Offices of Real Estate Agents & Brokers	Distinctive Homes Sothebys Int	7	Office_P	7
221320	Sewage Treatment Facilities	Douglas County Sewer Improveme	15	Goods_P	15
445110	Supermarkets and Other Grocery Stores	Safeway Inc.	75	Retail	75
452990	All Other General Merchandise Stores	Dollar Tree	3	Retail	3

Douglas County/Carson City Regional Travel Demand Model

SIC_CODE	Industry	Trade_Name	Employment	Model_Category	Total_Emp
522110	Commercial Banking	Wells Fargo Bank North America	7	Office_P	7
541712	Research and Development in the Physical, Eng	Zephyr Photonics Inc	25	Office_P	25
621111	Offices of Physicians, ex. Mental Health	Rupp Medical Corporation	3	Medical	3
621111	Offices of Physicians, ex. Mental Health	Keith Swanson MD	3	Medical	3
621111	Offices of Physicians, ex. Mental Health	Ker Swanson PC	3	Medical	3
621111	Offices of Physicians, ex. Mental Health	Lake Tahoe Orthopedic Institute	7	Medical	7
621111	Offices of Physicians, ex. Mental Health	Lake Tahoe Orthopaedic Institute	15	Medical	15
621493	Freestanding Emergency Medical Centers	Surgical Assoc of Lake Tahoe	3	Medical	3
722511	Full-Service Restaurants	Coyote Grill	3	Food_Dr	3
722511	Full-Service Restaurants	On the Rocks	7	Food_Dr	7
722511	Full-Service Restaurants	Milky Way Inc 401k Profit Shar	7	Food_Dr	7
722513	Limited-Service Restaurants	Subway 35900	7	Food_Dr	7
722515	Snack and Nonalcoholic Beverage Bars	Bean Bar	7	Food_Dr	7
922160	Fire Protection	Tahoe Douglas Fire Protection	85	Office_G	85
238321	Residential Painting Contractors	Painting Contractors Inc	7	Constru	7
238911	Residential Site Preparation Contractors	Buckeye Construction & Excavat	3	Constru	3
423720	Plumbing Goods Merchant Wholesalers	Sunwest Mfg & Supply Inc	3	Ware_H	3
454390	Other Direct Selling Establishments	Sanford Family Inc	1	Retail	1
488510	Freight Transportation Arrangement	Hawaiian Expeditors	3	Office_P	3
523910	Miscellaneous Intermediation	Santa Rosa Land Development Co	1	Office_P	1
524126	Direct Property and Casualty Insurers	Cabrillo Pacific Insurance Ser	3	Office_P	3
531311	Residential Property Managers	RH Holdings Inc	3	Office_P	3
532490	Other Machinery Rental and Leasing	PJS Enterprises LLC	3	Other	3
541219	Other Accounting Services	Resource LLC	3	Office_P	3
541330	Engineering Services	Quality Validation 360 Incorpo	3	Office_P	3
541511	Custom Computer Programming Services	BPT Enterprises Inc	3	Office_P	3
561720	Janatorial Services	1-866-Yb Messy	3	Other	3
813990	Other Similar Organizations	Lake Village Homeowners Assn	7	Office_P	7
814110	Private Households	Dana Chaiken	3	Other	3
814110	Private Households	Alfonso G Cordero	3	Other	3
621493	Freestanding Emergency Medical Centers	Lake Tahoe Surgery Center	7	Medical	7
238161	Residential Roofing Contractors	Hi & Dry Roofing Ltd	7	Constru	7
721211	RV Parks and Campgrounds	California Land Management	7	Other	7
541110	Offices of Lawyers	Deborah A Palmer A Law Corp	1	Office_P	1
541110	Offices of Lawyers	George W Echan	3	Office_P	3
541211	Offices of Certified Public Accountants	Jack Marcarelli CPA MBA	3	Office_P	3

Douglas County/Carson City Regional Travel Demand Model

SIC_CODE	Industry	Trade_Name	Employment	Model_Category	Total_Emp
813990	Other Similar Organizations	Elkpoint Country Club	3	Office_P	3
531110	Lessors of Residential Buildings	Jackson Rancheria Development	1	Office_P	1
423930	Recyclable Material Merchant Wholesalers	Dental Refiners Inc	7	Ware_H	7
423940	Jewelry Merchant Wholesalers	Godiam Diamonds Inc	1	Ware_H	1
485320	Limosine Service	Lakeshore Pacific Nevada Inc	7	Other	7
611610	Fine Arts Schools	Forever Dance Lake Tahoe	15	School	15
812320	Drycleaning and Laundry Services	Roundhill Cleaners	3	Retail	3
541690	Other Technical Consulting Services	Alice Communication Inc	3	Office_P	3
339910	Jewelry and Silverware Manufacturing	Wages Rodeo Silversmiths	7	Goods_P	7
621210	Offices of Dentists	Zephyr Cove Dental Center	15	Medical	15
541511	Custom Computer Programming Services	Opus Technologies Inc	1	Office_P	1
522320	Financial Transaction Process/Clearing	Sterling Buying Group	3	Office_P	3
425120	Wholesale Trade Agents and Brokers	Cooper Power Systems LLC	1	Other	1
531311	Residential Property Managers	Wow Vacation Rentals	3	Office_P	3
561510	Travel Agencies	American Express Travel Related Srv	3	Office_P	3
711320	Promoters without Facilities	USASA	3	Other	3
531210	Offices of Real Estate Agents & Brokers	Craig Zager Inc	3	Office_P	3
541519	Other Computer Related Services	Electronic Coconut Inc	3	Office_P	3
921140	Executive & Legislative Offices Combined	Round Hill General Improvement	7	Office_G	7
561740	Carpet and Upholstery Cleaning Services	Carpet Cops	3	Other	3
541519	Other Computer Related Services	MDR Computer Consulting Inc	1	Office_P	1
541611	Administrative Management Consulting Svc	Subway Russia LLC	3	Office_P	3
238222	Nonresidential Plumbing/HVAC Contractors	South Shore Fire Sprinkler Inc	3	Constru	3
332911	Industrial Valve Manufacturing	American AVK Company	75	Goods_P	75
236115	New Single-Family Housing Construction	PCCI	3	Constru	3
111940	Hay Farming	Genoa Livestock LLC	3	Other	3
444220	Nursery, Garden & Farm Supply Stores	Genoa Trees & Landscape Materi	7	Retail	7
813990	Other Similar Organizations	Pinewild Condo Homeowners Assn	1	Office_P	1
236118	Residential Remodelers	Steve Breit Painting	3	Constru	3
236115	New Single-Family Housing Construction	Russ Irwin Construction	1	Constru	1
236118	Residential Remodelers	Russ Irwin Construction	7	Constru	7
236118	Residential Remodelers	Nevada East Shore Builders Inc	7	Constru	7
541611	Administrative Management Consulting Svc	Expressworks Federal	3	Office_P	3
531311	Residential Property Managers	Tahoe Management Services Co L	3	Office_P	3
237310	Highway, Street, and Bridge Construction	RDK Construction Inc	3	Constru	3
445310	Beer, Wine, and Liquor Stores	Lakeside Liquor & Smoke	3	Retail	3

Douglas County/Carson City Regional Travel Demand Model

SIC_CODE	Industry	Trade_Name	Employment	Model_Category	Total_Emp
531110	Lessors of Residential Buildings	Western Highland Mgmt Co	3	Office_P	3
722511	Full-Service Restaurants	Sams Place	15	Food_Dr	15
541611	Administrative Management Consulting Svc	Dentpro Inc	3	Office_P	3
115210	Support Activities for Animal Production	Two Dog Farms Inc	3	Other	3
454111	Electronic Shopping	Neddys Inc	3	Retail	3
541511	Custom Computer Programming Services	International Asset Systems US	1	Office_P	1
491110	Postal Service	USPS Genoa	3	Other	3
333611	Turbine Generator & Generator Set Units	Turbine Blading and Parts LLC	25	Goods_P	25
531210	Offices of Real Estate Agents & Brokers	Wegis Enterprises Inc	1	Office_P	1
721110	Hotels (except Casino Hotels) and Motels	Walleys Property Owners Associ	25	Hotel_NG	25
721110	Hotels (except Casino Hotels) and Motels	1862 David Walleys Hot Springs	45	Hotel_NG	45
722511	Full-Service Restaurants	1862 David Walleys Hot Springs	65	Food_Dr	65
812320	Drycleaning and Laundry Services	Tahoe Laundry Center	3	Retail	3
332710	Machine Shops	B&B Manufacturing Nevada Facil	3	Goods_P	3
332710	Machine Shops	Twin Eagles Ltd	15	Goods_P	15
541219	Other Accounting Services	PIC Services	3	Office_P	3
541420	Industrial Design Services	Transtector Systems Inc	15	Office_P	15
541690	Other Technical Consulting Services	Tamarack Technologies	3	Office_P	3
311920	Coffee and Tea Manufacturing	Alpen Sierra Coffee Roasting C	15	Goods_P	15
423310	Lumber and Wood Merchant Wholesalers	Screen Systems By Genius	3	Ware_H	3
423620	Electric Appliance Merchant Wholesalers	CIT Electronics	7	Ware_H	7
423690	Other Electronic Parts Merchant Whsle	Sierra Components Inc	7	Ware_H	7
423720	Plumbing Goods Merchant Wholesalers	Hercke	3	Ware_H	3
453998	Store Retailers Not Specified Elsewhere	Hoof Care & Farrier Supply LLC	1	Retail	1
518210	Data Processing and Related Services	Tecknet Inc	3	Office_P	3
519130	Internet Publishing & Broadcasting and Web Se	Sportfishingreport.Com Inc	3	Office_P	3
561730	Landscaping Services	Mountain High Lawns	25	Other	25
336991	Motorcycle, Bicycle, and Parts Mfg	Patmont Motor Werks	15	Goods_P	15
551114	Managing Offices	Eastbiz Corporation	3	Office_P	3
561431	Private Mail Centers	Shipito LLC	25	Office_P	25
238212	Nonresidential Electrical Contractors	United Electrical Services Inc	35	Constru	35
444190	Other Building Material Dealers	Nova Tile & Stone Nevada	15	Retail	15
551114	Managing Offices	Artison LLC	7	Office_P	7
611620	Sports and Recreation Instruction	Tumbleweeds Gynmastics	45	School	45
487110	Scenic/Sightseeing Transportation, Land	High Altitude Tours	1	Other	1
334419	Other Electronic Component Manufacturing	Sonoma Scientific Inc	15	Goods_P	15

Douglas County/Carson City Regional Travel Demand Model

SIC_CODE	Industry	Trade_Name	Employment	Model_Category	Total_Emp
424690	Other Chemical Merchant Wholesalers	Metalast Surface Technology LI	3	Ware_H	3
518210	Data Processing and Related Services	LIMA3 Systems	3	Office_P	3
531210	Offices of Real Estate Agents & Brokers	Sierra Nevada Realty Group Inc	3	Office_P	3
551114	Managing Offices	Security Management Group Inte	1	Office_P	1
999999	Unknown Industry	Gresco Inc	3	Other	3
332994	Small Arms Manufacturing	Franklin Armory	3	Goods_P	3
238151	Residential Glass/Glazing Contractors	Carson Valley Glass	3	Constru	3
334416	Electronic Coils, Transformer & Inductor	Diablo Industries	55	Goods_P	55
454111	Electronic Shopping	Power Notebooks.Com	3	Retail	3
611610	Fine Arts Schools	Van Gogh & Vino	3	School	3
722511	Full-Service Restaurants	Flight Restaurant & Bar	15	Food_Dr	15
551114	Managing Offices	AFASSCO Inc	15	Office_P	15
488190	Other Support Activities, Air Transport	Rebuilt Aircraft Inc	3	Other	3
924120	Administration of Conservation Programs	Bureau of Land Mgmt	7	Office_G	7
326199	All Other Plastics Product Manufacturing	Fair Trails Enterprises Inc	3	Goods_P	3
332710	Machine Shops	Hubzone Manufacturing Inc	3	Goods_P	3
333994	Industrial Process Furnaces and Ovens	AIM Manufacturing	7	Goods_P	7
423690	Other Electronic Parts Merchant Whsle	Chaparral Avionics Inc	1	Ware_H	1
481212	Nonscheduled Air Freight Chartering	Skydance Helicopters of N NV I	15	Other	15
488190	Other Support Activities, Air Transport	Aces Aircraft Maintenance Inc	7	Other	7
522292	Real Estate Credit	Sierra Pacific Mortgage	3	Office_P	3
524210	Insurance Agencies and Brokerages	Raker Insurance Agency Inc	3	Office_P	3
524210	Insurance Agencies and Brokerages	Glatfelter Insurance Group	3	Office_P	3
532412	Other Heavy Machinery Rental and Leasing	J.C Custom Woodworks and Equip	3	Other	3
561320	Temporary Help Services	Blue Ribbon Personnel Services	25	Office_P	25
814110	Private Households	Destination Sports Inc	3	Other	3
532411	Transportation Equipment Rental/Leasing	Pantechnicon Aviation Ltd	7	Other	7
551114	Managing Offices	JKC Enterprises Inc	3	Office_P	3
236220	Commercial Building Construction	AI Shankle Construction Compan	7	Constru	7
423610	Wiring & Equipment Merchant Wholesalers	Futurelux Inc	3	Ware_H	3
519190	All Other Information Services	Worklife Essentials Inc	1	Office_P	1
522291	Consumer Lending	ThunderRoad Financial	3	Office_P	3
523910	Miscellaneous Intermediation	DKG Investments Inc	3	Office_P	3
531210	Offices of Real Estate Agents & Brokers	Spyglass Enterprises Inc	1	Office_P	1
541512	Computer Systems Design Services	Class 1 Technologies	1	Office_P	1
541611	Administrative Management Consulting Svc	Black River Company, The	3	Office_P	3

Douglas County/Carson City Regional Travel Demand Model

SIC_CODE	Industry	Trade_Name	Employment	Model_Category	Total_Emp
541810	Advertising Agencies	LMCD Marketing Inc	1	Office_P	1
561612	Security Guards and Patrol Services	Resolute Security Group Inc	7	Other	7
487210	Scenic/Sightseeing Transportation, Water	Lake Tahoe Boat Company LLC	15	Other	15
532292	Recreational Goods Rental	H2O Sports	1	Other	1
541219	Other Accounting Services	Allied Imports & Logistics Inc	3	Office_P	3
541219	Other Accounting Services	Mendocino Greenhouse & Garden	3	Office_P	3
541219	Other Accounting Services	San Diego Hydroponics & Organi	3	Office_P	3
541219	Other Accounting Services	San Diego Hydroponics & Organi	3	Office_P	3
711510	Independent Artists/Writers/Performers	Live Out Loud	15	Other	15
713930	Marinas	Round Hill Pines Beach Resort	45	Other	45
814110	Private Households	Kirk B Ledbetter	7	Other	7
325412	Pharmaceutical Preparation Manufacturing	HCI Sciences Llc	3	Goods_P	3
424330	Women's Clothing Merchant Wholesalers	Fit2Race	3	Ware_H	3
488190	Other Support Activities, Air Transport	Minden Aircraft Repair Inc	3	Other	3
311411	Frozen Fruit and Vegetable Manufacturing	Continuum Packing Solutions LI	35	Goods_P	35
311812	Commercial Bakeries	Gourmet Baking Inc	25	Goods_P	25
811219	Other Electronic Equipment Repair	Qiagen Inc	7	Retail	7
811219	Other Electronic Equipment Repair	Excalibur Lab Specialists Inc	15	Retail	15
423450	Medical Equipment Merchant Wholesalers	Diagnostic-Monitor Software LI	3	Ware_H	3
337110	Wood Kitchen Cabinets and Countertops	Expert Cabinets LLC	3	Goods_P	3
522320	Financial Transaction Process/Clearing	Petroleum Card Services	25	Office_P	25
531311	Residential Property Managers	Action Property Management Inc	3	Office_P	3
531311	Residential Property Managers	Community Association Manageme	3	Office_P	3
541420	Industrial Design Services	Beneficial Designs Inc	15	Office_P	15
541611	Administrative Management Consulting Svc	Monsters Inc	1	Office_P	1
551114	Managing Offices	Ibbotson Assoc Inc	1	Office_P	1
561990	All Other Support Services	Exclusively Auctions	1	Other	1
325314	Fertilizer (Mixing Only) Manufacturing	Great Basin Organics	3	Goods_P	3
454310	Fuel Dealers	Universal Propane of Minden In	3	Retail	3
481211	Nonscheduled Air Passenger Chartering	Hutt Aviation Inc	7	Other	7
425120	Wholesale Trade Agents and Brokers	Syclone Corporation	3	Other	3
722511	Full-Service Restaurants	Tail Dragger Cafe	15	Food_Dr	15
336612	Boat Building	Aviso LLC	1	Goods_P	1
336612	Boat Building	Solution Marine LLC	3	Goods_P	3
339112	Surgical and Medical Instrument Mfg	Med X Composites LLC	7	Goods_P	7
551114	Managing Offices	Solution Inc	3	Office_P	3

Douglas County/Carson City Regional Travel Demand Model

SIC_CODE	Industry	Trade_Name	Employment	Model_Category	Total_Emp
424920	Book & Periodical Merchant Wholesalers	More Company Inc	3	Ware_H	3
611512	Flight Training	Soaring NV LLC	25	School	25
488190	Other Support Activities, Air Transport	AMT Associates L.P	3	Other	3
561210	Facilities Support Services	ABS Aviation Inc	7	Office_P	7
484220	Other Specialized Trucking, Local	Zephyr Truck & Equipment	1	Other	1
522320	Financial Transaction Process/Clearing	Softrix Corporation	3	Office_P	3
425120	Wholesale Trade Agents and Brokers	Telmon Corporation	3	Other	3
237110	Water and Sewer System Construction	Boyd Geothermal Drilling	1	Constru	1
445299	All Other Specialty Food Stores	Trimmer Outpost	3	Retail	3
453310	Used Merchandise Stores	No Nos Sweet Repeats	3	Retail	3
423940	Jewelry Merchant Wholesalers	Tahoe Creations Inc	1	Ware_H	1
711510	Independent Artists/Writers/Performers	Fast Publications	1	Other	1
722511	Full-Service Restaurants	La Ferme LLC	7	Food_Dr	7
722410	Drinking Places (Alcoholic Beverages)	Genoa Bar And Saloon	3	Food_Dr	3
541511	Custom Computer Programming Services	Bergstrom-Seq.Com	1	Office_P	1
445110	Supermarkets and Other Grocery Stores	Genoa Country Store	7	Retail	7
531210	Offices of Real Estate Agents & Brokers	Gillmor Coons Real Estate Grou	3	Office_P	3
712190	Nature Parks & Other Similar Institution	Parks Division	3	Other	3
236117	New Housing Operative Builders	Davidon Homes	1	Constru	1
236118	Residential Remodelers	Campau Group, The	3	Constru	3
237110	Water and Sewer System Construction	Sierra Eco Systems	3	Constru	3
332510	Hardware Manufacturing	Airfilm Camera Systems Inc	3	Goods_P	3
531120	Lessors of Nonresidential Buildings	Kiddox Management Inc	3	Office_P	3
531210	Offices of Real Estate Agents & Brokers	Canyon Creek Realty LLC	3	Office_P	3
541613	Marketing Consulting Services	Global Wine Connections	1	Office_P	1
541921	Photography Studios, Portrait	Miner Productions	1	Office_P	1
713940	Fitness and Recreational Sports Centers	Montana Homeowner Association	3	Other	3
522310	Mortgage and Nonmortgage Loan Brokers	Ireverse Home Loans LLC	1	Office_P	1
721110	Hotels (except Casino Hotels) and Motels	Genoa Country Inn	1	Hotel_NG	1
236118	Residential Remodelers	Steve Yochum Construction	3	Constru	3
237990	Other Heavy Construction	Advanced Marine Services Corp	3	Constru	3
487210	Scenic/Sightseeing Transportation, Water	Woodwind Sailing Cruises	15	Other	15
722310	Food Service Contractors	Lake Tahoe	150	Food_Dr	150
711510	Independent Artists/Writers/Performers	Sawyer & Williams Inc	3	Other	3
236115	New Single-Family Housing Construction	Genoa Company Inc, The	1	Constru	1
541219	Other Accounting Services	USA Tech Support A Close Corpo	3	Office_P	3

Douglas County/Carson City Regional Travel Demand Model

SIC_CODE	Industry	Trade_Name	Employment	Model_Category	Total_Emp
532490	Other Machinery Rental and Leasing	CC Industries Llc	3	Other	3
334412	Bare Printed Circuit Board Manufacturing	Under Control Inc	1	Goods_P	1
611110	Elementary and Secondary Schools	Grace Christian Academy	15	School	15
238911	Residential Site Preparation Contractors	Acme Bobcat	1	Constru	1
711219	Other Spectator Sports	Sierra Sierra Enterprises	3	Other	3
115310	Support Activities for Forestry	Minden Air Corp	15	Goods_P	15
713910	Golf Courses and Country Clubs	Golf Club at Genoa Lakes, The	55	Other	55
924120	Administration of Conservation Programs	Wildlife Department	3	Office_G	3
924120	Administration of Conservation Programs	Forestry Division	15	Office_G	15
713990	All Other Amusement and Recreation Ind	Zephyr Cove Stables LLC	7	Other	7
115210	Support Activities for Animal Production	Jacks Valley Stables	3	Other	3
236115	New Single-Family Housing Construction	Donald R Leverty Inc	3	Constru	3
337110	Wood Kitchen Cabinets and Countertops	Balda Innovations Inc	3	Goods_P	3
713910	Golf Courses and Country Clubs	Genoa Lakes Golf Resort	25	Other	25
814110	Private Households	Mark Granat	3	Other	3
314910	Textile Bag and Canvas Mills	North Sails Nevada	55	Goods_P	55
333318	Other Commercial and Service Industry Machine	Nevada Filtration Systems	15	Goods_P	15
551114	Managing Offices	Soc Nevada LLC	45	Office_P	45
488119	Other Airport Operations	CAPCO	3	Other	3
561720	Janatorial Services	All Clean Janitorial	3	Other	3
814110	Private Households	Robin Hollingshead	3	Other	3
561320	Temporary Help Services	P/S Partner Solutions Ltd	3	Office_P	3
531210	Offices of Real Estate Agents & Brokers	Russell Davidson Inc	1	Office_P	1
238131	Residential Framing Contractors	Ac Christian Inc	1	Constru	1
518210	Data Processing and Related Services	Compliance Data Center LLC	3	Office_P	3
311920	Coffee and Tea Manufacturing	Starbucks Manufacturing Corpor	150	Goods_P	150
493110	General Warehousing and Storage	Starbucks Coffee	150	Ware_H	150
335999	Miscellaneous Electrical Equipment	Emco	25	Goods_P	25
336991	Motorcycle, Bicycle, and Parts Mfg	Techspec	7	Goods_P	7
541330	Engineering Services	Hawltech Inc	1	Office_P	1
562998	Miscellaneous Waste Management Services	Alpine Septic & Pumping Inc	3	Other	3
236115	New Single-Family Housing Construction	Syncon Homes	7	Constru	7
531210	Offices of Real Estate Agents & Brokers	Susan E Berch Inc	1	Office_P	1
541380	Testing Laboratories	X Test Inc	3	Office_P	3
541611	Administrative Management Consulting Svc	Leanims	1	Office_P	1
541611	Administrative Management Consulting Svc	J Poe Consulting Inc	1	Office_P	1

Douglas County/Carson City Regional Travel Demand Model

SIC_CODE	Industry	Trade_Name	Employment	Model_Category	Total_Emp
531110	Lessors of Residential Buildings	Genie Corporation	3	Office_P	3
236118	Residential Remodelers	Englekirk Construction LLC	1	Constru	1
561730	Landscaping Services	J B Landscaping	15	Other	15
711510	Independent Artists/Writers/Performers	Woodbridge Productions Ltd	3	Other	3
333515	Machine Tool Cutters and Accessories	American International Tooling	25	Goods_P	25
423990	All Other Durable Goods Merchant Whsle	International Network In Advan	3	Ware_H	3
541330	Engineering Services	Three Castles Engineering	3	Office_P	3
611430	Management Training	Leading Edge Leadership Development	3	School	3
238221	Residential Plumbing/HVAC Contractors	Coastal Aire & Sheet Metal Inc	7	Constru	7
238222	Nonresidential Plumbing/HVAC Contractors	Rep Plumbing	15	Constru	15
238312	Nonresidential Drywall Contractors	Jackson Quality Drywall & Int	85	Constru	85
238912	Nonresidential Site Preparation Contrs	Herback Gen Engineering Llc	25	Constru	25
423120	New Motor Vehicle Part Merchant Whsle	Ramac Industries Inc	15	Ware_H	15
561320	Temporary Help Services	Special Counsel Inc	1	Office_P	1
423820	Farm & Garden Equip Merchant Wholesalers	Reliance Parts Corporation	1	Ware_H	1
423820	Farm & Garden Equip Merchant Wholesalers	Reliance Parts	25	Ware_H	25
541511	Custom Computer Programming Services	Skylake Software Inc	3	Office_P	3
332710	Machine Shops	Pacific Machining Inc	7	Goods_P	7
332812	Metal Coating and Nonprecious Engraving	Pacific Finishing Inc	3	Goods_P	3
332710	Machine Shops	JRB Machine	7	Goods_P	7
423820	Farm & Garden Equip Merchant Wholesalers	American Impact Sprinkler Company	7	Ware_H	7
238221	Residential Plumbing/HVAC Contractors	Robert Sandy Plumbing Inc	3	Constru	3
314910	Textile Bag and Canvas Mills	North Sails Nevada	45	Goods_P	45
334220	Broadcast & Wireless Communication Equip	Pacific Radomes Inc	25	Goods_P	25
487110	Scenic/Sightseeing Transportation, Land	Nevada Adventure Company Inc	3	Other	3
332710	Machine Shops	PME of Ohio Inc	15	Goods_P	15
238332	Nonresidential Flooring Contractors	Js Flooring / Kutpile	7	Constru	7
442210	Floor Covering Stores	J & S Floors Inc	1	Retail	1
541712	Research and Development in the Physical, Eng	Frontline Medical Products	3	Office_P	3
311520	Ice Cream & Frozen Dessert Manufacturing	Hoch Family Creamery	3	Goods_P	3
323111	Commercial Gravure Printing	R & S Optimum Offset	3	Goods_P	3
451130	Sewing, Needlework & Piece Goods Stores	Fabric Chicks Creative Oasis	3	Retail	3
238161	Residential Roofing Contractors	Coyne Roofing Inc	7	Constru	7
339920	Sporting & Athletic Goods Manufacturing	Flatwater Paddle Co	3	Goods_P	3
325412	Pharmaceutical Preparation Manufacturing	Life Enhancement Products Inc	15	Goods_P	15
541613	Marketing Consulting Services	Hycomb Marketing Inc	3	Office_P	3

Douglas County/Carson City Regional Travel Demand Model

SIC_CODE	Industry	Trade_Name	Employment	Model_Category	Total_Emp
325991	Custom Compounding of Purchased Resins	Lam-Tex Composites Inc	7	Goods_P	7
332710	Machine Shops	Burns Machinery Inc	15	Goods_P	15
236220	Commercial Building Construction	Central Sierra Constr Inc	1	Constru	1
311920	Coffee and Tea Manufacturing	Sierra Kombucha Company LLC, T	1	Goods_P	1
424210	Druggists' Goods Merchant Wholesalers	RWA Serious Beauty Inc	15	Ware_H	15
444190	Other Building Material Dealers	Superior Door & Window	3	Retail	3
611110	Elementary and Secondary Schools	Rite of Passage	3	School	3
623990	Other Residential Care Facilities	Rop Adolescent Treatment Ctr & Scho	35	Other	35
623990	Other Residential Care Facilities	Rite of Passage Inc	55	Other	55
551114	Managing Offices	Golden State Landscaping	3	Office_P	3
238311	Residential Drywall Contractors	Legacy Specialties Inc	150	Constru	150
561730	Landscaping Services	Luke Landscape Contractors LLC	25	Other	25
332323	Ornamental and Architectural Metal Work	Innovative Equine Systems	3	Goods_P	3
454111	Electronic Shopping	Silk And Sable Inc	7	Retail	7
621999	Miscellaneous Ambulatory Health Care Svc	Optimalaire	3	Medical	3
531120	Lessors of Nonresidential Buildings	Gersick Enterprises Inc	3	Office_P	3
423710	Hardware Merchant Wholesalers	Alpine Fastener & Hardware Inc	3	Ware_H	3
337110	Wood Kitchen Cabinets and Countertops	Western Woodworking	7	Goods_P	7
337110	Wood Kitchen Cabinets and Countertops	Custom Design Woodworks Inc	7	Goods_P	7
541511	Custom Computer Programming Services	Cyber-Nexus Limited	1	Office_P	1
238912	Nonresidential Site Preparation Contrs	V & C Construction Inc	25	Constru	25
238341	Residential Tile/Terrazzo Contractors	Stiltz Tile Llc	15	Constru	15
238342	Nonresidential Tile/Terrazzo Contractors	Stiltz Marble & Granite Inc	7	Constru	7
713990	All Other Amusement and Recreation Ind	Keeping The Doors Open	1	Other	1
236118	Residential Remodelers	Moore Home Improvements Inc	1	Constru	1
713930	Marinas	Walker Marine	7	Other	7
811121	Automotive Body and Interior Repair	Welcomes Auto Body Mfg	3	Retail	3
238991	All Other Residential Trade Contractors	Florence Fence Inc	15	Constru	15
447110	Gasoline Stations w/ Convenience Stores	Johnson Lane General Store	15	Retail	15
561730	Landscaping Services	Green Things	3	Other	3
238321	Residential Painting Contractors	Sclafani Painting Inc	7	Constru	7
561311	Employment Placement Agencies	Search Associates Consultants	3	Office_P	3
238221	Residential Plumbing/HVAC Contractors	Smiths Plumbing LLC	3	Constru	3
811310	Commercial Machinery Repair/Maintenance	S&D Diesel Injection Service	3	Retail	3
238221	Residential Plumbing/HVAC Contractors	Elite Air Systems	3	Constru	3
561720	Janatorial Services	Professional Image Cleaning Se	1	Other	1

Douglas County/Carson City Regional Travel Demand Model

SIC_CODE	Industry	Trade_Name	Employment	Model_Category	Total_Emp
541330	Engineering Services	Andress Composites Inc	3	Office_P	3
238911	Residential Site Preparation Contractors	Fairway Excavating Inc	3	Constru	3
238142	Nonresidential Masonry Contractors	Keystone Masonry	7	Constru	7
624110	Child and Youth Services	Shenae Liggett	3	Other	3
541512	Computer Systems Design Services	CMS Collaborative Inc	3	Office_P	3
811211	Consumer Electronics Repair/Maintenance	True Sound Works Audio Inc	3	Retail	3
238211	Residential Electrical Contractors	Coleman Electric Company	3	Constru	3
814110	Private Households	Woelfel li, Robert L	3	Other	3
236220	Commercial Building Construction	MD Barns Northern Nevada	3	Constru	3
561730	Landscaping Services	Naturally Beautiful Gardens	1	Other	1
541511	Custom Computer Programming Services	Sierra Automation Inc	3	Office_P	3
624410	Child Day Care Services	Kids Kind of Place Preschool &	7	Other	7
531210	Offices of Real Estate Agents & Brokers	Beverly J Cashen Prof Corp	3	Office_P	3
238161	Residential Roofing Contractors	RM Roofing Company Inc	3	Constru	3
561720	Janatorial Services	American Cleaning Corp	1	Other	1
236115	New Single-Family Housing Construction	Sns Construction Solutions	1	Constru	1
541219	Other Accounting Services	V Donovan Accountancy Inc	1	Office_P	1
238341	Residential Tile/Terrazzo Contractors	Dub Tile	15	Constru	15
561410	Document Preparation Services	Colorado School of Dental Assi	7	Office_P	7
561311	Employment Placement Agencies	Bullseye Jobs	1	Office_P	1
541211	Offices of Certified Public Accountants	Robert F Albonico CPA	1	Office_P	1
236118	Residential Remodelers	Matt Gerken Construction	3	Constru	3
238221	Residential Plumbing/HVAC Contractors	Gore Plumbing Inc	7	Constru	7
238351	Residential Finish Carpentry Contractors	Gunsten Construction Llc	3	Constru	3
541611	Administrative Management Consulting Svc	Schlenger Corp	1	Office_P	1
541370	Other Surveying and Mapping Services	Caldera Land Surveying Inc	1	Office_P	1
238321	Residential Painting Contractors	Strong Painting & Decorative A	3	Constru	3
238211	Residential Electrical Contractors	Carson Tahoe Electric	1	Constru	1
339950	Sign Manufacturing	Valley Creek Enterprises	3	Goods_P	3
339950	Sign Manufacturing	Valley Creek Enterprises	3	Goods_P	3
531210	Offices of Real Estate Agents & Brokers	Page Inc	3	Office_P	3
541330	Engineering Services	W Ferree & Associates	3	Office_P	3
237110	Water and Sewer System Construction	Kawchack Pump & Well Service	7	Constru	7
491110	Postal Service	April Slankard	3	Other	3
999999	Unknown Industry	Gerald Jilk Construction	3	Other	3
453310	Used Merchandise Stores	Chapel Antiques	3	Retail	3

Douglas County/Carson City Regional Travel Demand Model

SIC_CODE	Industry	Trade_Name	Employment	Model_Category	Total_Emp
522320	Financial Transaction Process/Clearing	Intrinsic Merchant Services	3	Office_P	3
425120	Wholesale Trade Agents and Brokers	Nevacoast LLC	3	Other	3
561790	Other Services to Buildings & Dwellings	Landscape & Snow Removal Service	1	Other	1
236118	Residential Remodelers	Toiyabe Builders	1	Constru	1
238911	Residential Site Preparation Contractors	Gleave Construction LLC	3	Constru	3
531320	Offices of Real Estate Appraisers	High Desert Appraisal Svc Mind	1	Office_P	1
561611	Investigation Services	Allen Investigations LLC	3	Office_P	3
511210	Software Publishers	22learn LLC	3	Office_P	3
523910	Miscellaneous Intermediation	Akin Contextural Research Ltd	1	Office_P	1
611620	Sports and Recreation Instruction	Kids & Horses	7	School	7
541330	Engineering Services	Morris Engineering Ltd	3	Office_P	3
425120	Wholesale Trade Agents and Brokers	Bruce Foods Corp	1	Other	1
236118	Residential Remodelers	Arrow Remodeling & Renovation	3	Constru	3
238221	Residential Plumbing/HVAC Contractors	Olson Heating & Air Conditioni	7	Constru	7
541690	Other Technical Consulting Services	Abbott Cardiovascular Systems	1	Office_P	1
541512	Computer Systems Design Services	Dbms Consulting Inc	3	Office_P	3
523920	Portfolio Management	Investment Services Holding Co	1	Office_P	1
926110	Administration of General Economic Prog	Bureau of the Census	3	Office_G	3
712190	Nature Parks & Other Similar Institution	Parks Division	3	Other	3
531210	Offices of Real Estate Agents & Brokers	Abundant Properties	1	Office_P	1
541512	Computer Systems Design Services	Strata Information Group	3	Office_P	3
541430	Graphic Design Services	Wendy Hoag Design Inc	1	Office_P	1
511210	Software Publishers	Real Time Monitors Inc	1	Office_P	1
511210	Software Publishers	Ffb Consulting Inc	1	Office_P	1
561730	Landscaping Services	Lawnmower Man Landscaping	3	Other	3
112111	Beef Cattle Ranching and Farming	Washoe One Stop	7	Other	7
238341	Residential Tile/Terrazzo Contractors	Supreme Tile	3	Constru	3
561612	Security Guards and Patrol Services	Santa Fe Protective Services I	1	Other	1
813910	Business Associations	Appraisal Institute	3	Office_P	3
517919	All Other Telecommunications	Sierra Ventrues, LLC	1	Office_P	1
812910	Pet Care (except Veterinary) Services	Country Inn Dog And Cat Kennel	3	Retail	3
238221	Residential Plumbing/HVAC Contractors	American Leak Detection	1	Constru	1
721211	RV Parks and Campgrounds	Silver City R.V Park	15	Other	15
814110	Private Households	Tara L Kavanaugh	1	Other	1
541219	Other Accounting Services	Sierra Bookkeeping Services	1	Office_P	1
551114	Managing Offices	Cmr Enterprises Inc	3	Office_P	3

Douglas County/Carson City Regional Travel Demand Model

SIC_CODE	Industry	Trade_Name	Employment	Model_Category	Total_Emp
112519	Other Aquaculture	Hungry Mother Organics	7	Goods_P	7
325314	Fertilizer (Mixing Only) Manufacturing	Full Circle Compost Inc	7	Goods_P	7
112111	Beef Cattle Ranching and Farming	Double Ja Land & Livestock Co	3	Other	3
814110	Private Households	Keith Benton	3	Other	3
238911	Residential Site Preparation Contractors	Horizon Construction Inc	3	Constru	3
621111	Offices of Physicians, ex. Mental Health	Randall L Goode Md Pc	3	Medical	3
541330	Engineering Services	First Texas Products Corp	3	Office_P	3
531130	Miniwarehouses and Self-Storage Unit	Carson Valley-Tahoe Self Storage	3	Office_P	3
541611	Administrative Management Consulting Svc	Mastrov Mark S	3	Office_P	3
814110	Private Households	Charlton H Buckley	3	Other	3
561599	All Other Travel Arrangement Services	Live Nation Worldwide Inc	15	Office_P	15
814110	Private Households	19 Kelly Circle Llc	3	Other	3
713910	Golf Courses and Country Clubs	Sunridge Golf Course	15	Other	15
561730	Landscaping Services	Martinez Landscaping	3	Other	3
541511	Custom Computer Programming Services	Remoba Inc	1	Office_P	1
814110	Private Households	David D Traitel	3	Other	3
481211	Nonscheduled Air Passenger Chartering	C-Corporation	1	Other	1
814110	Private Households	Darrell James Guzy	3	Other	3
221320	Sewage Treatment Facilities	Indian Hills Gid	15	Goods_P	15
541219	Other Accounting Services	RWL Management Inc	1	Office_P	1
425120	Wholesale Trade Agents and Brokers	Eastern Industries Group Inc	3	Other	3
561740	Carpet and Upholstery Cleaning Services	Better Carpet Cleaner/Summit Carpt	7	Other	7
813990	Other Similar Organizations	Glenbrook Homeowners Assn	15	Office_P	15
814110	Private Households	Glenbrook Account	3	Other	3
814110	Private Households	Post Mistress Properties Llc	3	Other	3
561622	Locksmiths	Cal-1 Services Inc	3	Other	3
611430	Management Training	Bowperson Pblshng & Trng Inc	3	School	3
551114	Managing Offices	Electronic Funds Corporation	3	Office_P	3
561720	Janatorial Services	Roseannes Cleaning Svc Inc	3	Other	3
621111	Offices of Physicians, ex. Mental Health	Diane G Oliver Md Chtd	1	Medical	1
621111	Offices of Physicians, ex. Mental Health	Tahoe Fracture & Orthopedic	85	Medical	85
621493	Freestanding Emergency Medical Centers	Carson-Douglas Ambulatory Surgical	15	Medical	15
621498	All Other Outpatient Care Centers	Comprehensive Pain Care Inc	3	Medical	3
621111	Offices of Physicians, ex. Mental Health	Christopher J Garrett Ltd	1	Medical	1
621111	Offices of Physicians, ex. Mental Health	James H Sullivan MD Pc	3	Medical	3
561440	Collection Agencies	National Business Factors Inc	3	Office_P	3

Douglas County/Carson City Regional Travel Demand Model

SIC_CODE	Industry	Trade_Name	Employment	Model_Category	Total_Emp
561440	Collection Agencies	Nbf Group Inc	15	Office_P	15
561440	Collection Agencies	National Business Factors of N	15	Office_P	15
445120	Convenience Stores	Carson Country Market	3	Retail	3
722511	Full-Service Restaurants	Allstar Grill	3	Food_Dr	3
722511	Full-Service Restaurants	Floral Vineyard And Khristophe	7	Food_Dr	7
621111	Offices of Physicians, ex. Mental Health	Tahoe Womens Care	7	Medical	7
447110	Gasoline Stations w/ Convenience Stores	Washoe One Stop	15	Retail	15
621111	Offices of Physicians, ex. Mental Health	Lake Tahoe Orthopaedic Institute	7	Medical	7
541110	Offices of Lawyers	Matuska Law Offices	3	Office_P	3
541940	Veterinary Services	Quail Ridge Animal Hospital LI	15	Office_P	15
238911	Residential Site Preparation Contractors	Dans Backhoe Service Inc	3	Constru	3
541350	Building Inspection Services	Tag Inspections	1	Office_P	1
722511	Full-Service Restaurants	Glenbrook Club	3	Food_Dr	3
561410	Document Preparation Services	Magnalite Systems Nevada	3	Office_P	3
812112	Beauty Salons	Cost Cutters	7	Retail	7
238321	Residential Painting Contractors	High Rollers Painting	3	Constru	3
541810	Advertising Agencies	On Course Multimedia Inc	3	Office_P	3
561720	Janatorial Services	Aspen House	7	Other	7
541611	Administrative Management Consulting Svc	Blomstrom Consulting Inc	1	Office_P	1
236117	New Housing Operative Builders	Big George Ventures LLC	3	Constru	3
531210	Offices of Real Estate Agents & Brokers	Cmb Equities Corporation	1	Office_P	1
713910	Golf Courses and Country Clubs	Glenbrook Club	7	Other	7
624221	Temporary Shelters	Austin's House	7	Other	7
541219	Other Accounting Services	MFAA Inc	3	Office_P	3
541511	Custom Computer Programming Services	MFO Inc	3	Office_P	3
238212	Nonresidential Electrical Contractors	Transmission & Distribution Sv	3	Constru	3
551114	Managing Offices	Conyes Construction Corporatio	3	Office_P	3
238161	Residential Roofing Contractors	Aspen Roofing Co Inc	3	Constru	3
238212	Nonresidential Electrical Contractors	Genoa Peak Electric	7	Constru	7
541511	Custom Computer Programming Services	Fatfractal Inc	3	Office_P	3
331491	Nonferrous, ex. Copper/Aluminum, Shaping	Birmingham Metals (Lord Corp Llc)	3	Goods_P	3
423990	All Other Durable Goods Merchant Whsle	Reed Geek Inc	3	Ware_H	3
444110	Home Centers	The Home Depot	150	Retail	150
813940	Political Organizations	National Voter Outreach Inc	1	Office_P	1
452112	Discount Department Stores	Target	85	Retail	85
541921	Photography Studios, Portrait	Portrait Studio at Target	7	Office_P	7

Douglas County/Carson City Regional Travel Demand Model

SIC_CODE	Industry	Trade_Name	Employment	Model_Category	Total_Emp
453210	Office Supplies and Stationery Stores	Staples the Office Superstore	15	Retail	15
442299	All Other Home Furnishings Stores	Niche #4, The	3	Retail	3
442299	All Other Home Furnishings Stores	Fast Frame	3	Retail	3
445310	Beer, Wine, and Liquor Stores	Jm Liquor	3	Retail	3
722511	Full-Service Restaurants	Port of Subs 139	7	Food_Dr	7
221310	Water Supply and Irrigation Systems	Sierra Estates Gnrl Impr Distr	3	Goods_P	3
448190	Other Clothing Stores	Uniformity	7	Retail	7
441228	Motorcycle, ATV, and All Other Motor Vehicle	Carson Motorsports	3	Retail	3
236115	New Single-Family Housing Construction	A R Chambers Construction Inc	7	Constru	7
238131	Residential Framing Contractors	Woodson Construction	3	Constru	3
237110	Water and Sewer System Construction	Blain Well Drilling & Pump Inc	7	Constru	7
238141	Residential Masonry Contractors	Carson-Tahoe Masonry Co	15	Constru	15
425120	Wholesale Trade Agents and Brokers	Nutriag USA	3	Other	3
454111	Electronic Shopping	Microcontroller Pros LLC	3	Retail	3
713990	All Other Amusement and Recreation Ind	Spooner Lake Inc	15	Other	15
339112	Surgical and Medical Instrument Mfg	L A B Instruments Ltd	3	Goods_P	3
236118	Residential Remodelers	Mattice Construction	3	Constru	3
238112	Nonresidential Poured Foundation Contrs	Sierra West Concrete Inc	15	Constru	15
451110	Sporting Goods Stores	Carson Valley Sports	15	Retail	15
722513	Limited-Service Restaurants	Jamba Juice #1335	15	Food_Dr	15
722513	Limited-Service Restaurants	Panda Express	15	Food_Dr	15
722515	Snack and Nonalcoholic Beverage Bars	Starbucks Coffee	15	Food_Dr	15
442299	All Other Home Furnishings Stores	Bed Bath & Beyond	15	Retail	15
443142	Electronics Stores	Spring Mobile	3	Retail	3
446120	Cosmetic and Beauty Supply Stores	Ulta Salon, Cosmetics & Fragrance	25	Retail	25
448120	Women's Clothing Stores	Maurices	7	Retail	7
448150	Clothing Accessories Stores	Claire's Boutiques Inc	7	Retail	7
448190	Other Clothing Stores	Halloween City	1	Retail	1
448210	Shoe Stores	Payless Shoes	7	Retail	7
448210	Shoe Stores	Famous Footwear	7	Retail	7
451110	Sporting Goods Stores	Bike Habitat	7	Retail	7
451120	Hobby, Toy, and Game Stores	Michaels Stores, Inc.	35	Retail	35
452112	Discount Department Stores	Marshalls Store Carson Cit	45	Retail	45
452990	All Other General Merchandise Stores	Dollar Tree	15	Retail	15
453910	Pet and Pet Supplies Stores	Petco	15	Retail	15
621320	Offices of Optometrists	Eyezone	3	Medical	3

Douglas County/Carson City Regional Travel Demand Model

SIC_CODE	Industry	Trade_Name	Employment	Model_Category	Total_Emp
451110	Sporting Goods Stores	702 Skate & Snowboard Shop	3	Retail	3
451110	Sporting Goods Stores	Play It Again Sports	7	Retail	7
446191	Food (Health) Supplement Stores	GNC	7	Retail	7
722513	Limited-Service Restaurants	Qdoba Mexican Grill	15	Food_Dr	15
812199	Other Personal Care Services	Massage Envy	25	Retail	25
522110	Commercial Banking	Bank of America	7	Office_P	7
443142	Electronics Stores	Best Buy Stores L.P.	65	Retail	65
452990	All Other General Merchandise Stores	Cost Plus Inc	15	Retail	15
443142	Electronics Stores	Cellco Ptnshp	15	Retail	15
722513	Limited-Service Restaurants	Round Table Pizza	15	Food_Dr	15
451120	Hobby, Toy, and Game Stores	Gamestop	7	Retail	7
541330	Engineering Services	Fugro Consultants Inc	3	Office_P	3
541512	Computer Systems Design Services	Working the Map	3	Office_P	3
541519	Other Computer Related Services	Enviance Inc	3	Office_P	3
541990	All Other Professional & Technical Svc	Fairchild Semiconductor	1	Office_P	1
561110	Office Administrative Services	Saldo Associates	1	Office_P	1
561431	Private Mail Centers	UPS Store 4959, The	3	Office_P	3
722511	Full-Service Restaurants	China Jade Horse Restaurant	3	Food_Dr	3
451140	Musical Instrument and Supplies Stores	99dollarguitars Inc	3	Retail	3
722513	Limited-Service Restaurants	In n Out Burger	45	Food_Dr	45
722511	Full-Service Restaurants	La Salsa Grill	3	Food_Dr	3
442210	Floor Covering Stores	Rogers Carpet One	15	Retail	15
442299	All Other Home Furnishings Stores	Pier 1 Imports (U.S.) Inc.	15	Retail	15
621210	Offices of Dentists	Absolute Dental Carson City LI	15	Medical	15
722513	Limited-Service Restaurants	Five Guys Burgers & Fries	15	Food_Dr	15
722513	Limited-Service Restaurants	Del Taco	15	Food_Dr	15
541219	Other Accounting Services	Alexander Energy	3	Office_P	3
814110	Private Households	Barbara K Alexander	3	Other	3
452910	Warehouse Clubs and Supercenters	Wal-Mart Supercenter	350	Super_C	350
621320	Offices of Optometrists	Eagle Vision	7	Medical	7
621399	Offices of Misc Health Practitioners	The Clinic At Walmart	3	Medical	3
722513	Limited-Service Restaurants	Mcdonald's	7	Food_Dr	7
812112	Beauty Salons	Smart Style	7	Retail	7
446130	Optical Goods Stores	National Vision, Inc	7	Retail	7
541213	Tax Preparation Services	Jackson Hewitt	1	Office_P	1
621320	Offices of Optometrists	Lara Mcknight OD & Associates	3	Medical	3

Douglas County/Carson City Regional Travel Demand Model

SIC_CODE	Industry	Trade_Name	Employment	Model_Category	Total_Emp
811191	Automotive Oil Change/Lubrication Shops	Jiffy Lube	15	Retail	15
722511	Full-Service Restaurants	Chilis	45	Food_Dr	45
713910	Golf Courses and Country Clubs	South Shore at Lake Las Vegas	3	Other	3
713910	Golf Courses and Country Clubs	Clear Creek Golf LLC	45	Other	45
237110	Water and Sewer System Construction	Tanto Irrigation LLC	1	Constru	1
522291	Consumer Lending	Dollar Loan Center	7	Office_P	7
443142	Electronics Stores	Sprint Corp	7	Retail	7
445110	Supermarkets and Other Grocery Stores	Trader Joe's Company	55	Retail	55
532210	Consumer Electronics & Appliances Rental	Rent-A-Center	7	Other	7
561990	All Other Support Services	Goodwill Industries of Northern NV	3	Other	3
621210	Offices of Dentists	Clear Creek Dental PLLC	7	Medical	7
722513	Limited-Service Restaurants	Subway	7	Food_Dr	7
722514	Cafeterias, Grill Buffets, and Buffets	King Buffet	7	Food_Dr	7
621210	Offices of Dentists	Carson City Orthodontics	7	Medical	7
238122	Nonresidential Structural Steel Contrs	Ststructures Incorporated	7	Constru	7
922120	Police Protection	Traffic Safety	7	Office_G	7
922120	Police Protection	Investigation Division	25	Office_G	25
922160	Fire Protection	Fire Marshal	25	Office_G	25
611430	Management Training	Department of Public Safety	7	School	7
922120	Police Protection	Highway Patrol	3	Office_G	3
922150	Parole Offices and Probation Offices	Parole and Probation	1	Office_G	1
922140	Correctional Institutions	Department of Corrections	450	Office_G	450
924120	Administration of Conservation Programs	Forestry Division	25	Office_G	25
221330	Steam and Air-Conditioning Supply	Noresco Holdings Inc	3	Goods_P	3
531130	Miniwarehouses and Self-Storage Unit	Carson Tahoe Self Storage	3	Office_P	3
621492	Kidney Dialysis Centers	Chardonnay Dialysis Inc	7	Medical	7
561720	Janatorial Services	Dons Maintenance Service	7	Other	7
443142	Electronics Stores	Wireless Advocates, Llc.	3	Retail	3
452910	Warehouse Clubs and Supercenters	Costco Wholesale Corp	250	Super_C	250
541890	Other Services Related to Advertising	Warehouse Demo Services, Inc.	35	Office_P	35
621320	Offices of Optometrists	Advanced Sierra Eyecare Inc	7	Medical	7
713210	Casinos (except Casino Hotels)	Bodines Casino	85	Other	85
922120	Police Protection	Peace Officers Standards & Tra	15	Office_G	15
624410	Child Day Care Services	Washoe Tribe of NV & Calif	3	Other	3
624221	Temporary Shelters	Advocates to End Domes Violenc	15	Other	15
921190	Other General Government Support	State Public Works Division	3	Office_G	3

Douglas County/Carson City Regional Travel Demand Model

SIC_CODE	Industry	Trade_Name	Employment	Model_Category	Total_Emp
922140	Correctional Institutions	Department of Corrections	150	Office_G	150
923130	Other Human Resource Program Admin	Commission on Tourism	3	Office_G	3
519120	Libraries and Archives	Washoe Tribe of NV & Calif	3	Office_G	3
624410	Child Day Care Services	Stewart Community	3	Other	3
238212	Nonresidential Electrical Contractors	Capitol City Electric Inc	3	Constru	3
238221	Residential Plumbing/HVAC Contractors	Big Hog Plumbing Inc	3	Constru	3
561730	Landscaping Services	Western Environments Inc	15	Other	15
814110	Private Households	Gerald Young	3	Other	3
238341	Residential Tile/Terrazzo Contractors	Geiser Tile & Stone	7	Constru	7
561730	Landscaping Services	Absolute Landscaping Inc	7	Other	7
238321	Residential Painting Contractors	Crowder Painting & Decorating	3	Constru	3
561730	Landscaping Services	Down 2 Earth Landscaping LLC	3	Other	3
722320	Caterers	Carson City BBQ Co LLC	15	Food_Dr	15
531130	Miniwarehouses and Self-Storage Unit	Grizzily's RV Storage	3	Office_P	3
561720	Janatorial Services	Silver State Building Maintena	3	Other	3
484220	Other Specialized Trucking, Local	Milky-Way Transport Co Inc	1	Other	1
453998	Store Retailers Not Specified Elsewhere	Arundel Auctions and Appraisal	7	Retail	7
531312	Nonresidential Property Managers	Carson Lanes	1	Office_P	1
624410	Child Day Care Services	Carson Lanes Day Care & Learni	7	Other	7
713950	Bowling Centers	Carson Lanes	15	Other	15
722511	Full-Service Restaurants	Johnny Rockets	15	Food_Dr	15
722513	Limited-Service Restaurants	Wallys Pizza & Subs	7	Food_Dr	7
722515	Snack and Nonalcoholic Beverage Bars	Kernels Popcorn	1	Food_Dr	1
722515	Snack and Nonalcoholic Beverage Bars	Genoa Candy And Coffee Co	3	Food_Dr	3
238221	Residential Plumbing/HVAC Contractors	Tech Plumbing & Heating Inc	15	Constru	15
445310	Beer, Wine, and Liquor Stores	Aloha Discount Wine & Liquors	3	Retail	3
621210	Offices of Dentists	Carson City Pediatric Dentistr	7	Medical	7
713940	Fitness and Recreational Sports Centers	Anytime Fitness	3	Other	3
811111	General Automotive Repair	Performance Auto Care	7	Retail	7
621492	Kidney Dialysis Centers	Liberty Dialysis Carson City	15	Medical	15
522110	Commercial Banking	US Bank National Assoc	7	Office_P	7
561720	Janatorial Services	Spotless Janitorial Services	3	Other	3
561730	Landscaping Services	Aztec Landscape	3	Other	3
441210	Recreational Vehicle Dealers	Michael Hohl Rv Center	25	Retail	25
713290	Other Gambling Industries	Dotty's	7	Other	7
722513	Limited-Service Restaurants	Papa Murphy's Take and Bake Pizza	15	Food_Dr	15

Douglas County/Carson City Regional Travel Demand Model

SIC_CODE	Industry	Trade_Name	Employment	Model_Category	Total_Emp
722511	Full-Service Restaurants	El Charro Avitia Inc	45	Food_Dr	45
453998	Store Retailers Not Specified Elsewhere	Naughty rr Nice	7	Retail	7
522110	Commercial Banking	Heritage Bank	7	Office_P	7
451211	Book Stores	Manger of Carson City, The	1	Retail	1
722511	Full-Service Restaurants	Beijing Palace LLC	7	Food_Dr	7
722511	Full-Service Restaurants	Red Hut Cafe	25	Food_Dr	25
445299	All Other Specialty Food Stores	Dream Dinners	15	Retail	15
722513	Limited-Service Restaurants	Pizza Factory Inc	3	Food_Dr	3
442110	Furniture Stores	Mattress Land By Sleep Fit	7	Retail	7
238221	Residential Plumbing/HVAC Contractors	Hawkins Heating & Air Conditio	7	Constru	7
447110	Gasoline Stations w/ Convenience Stores	Arco AM/PM #82341	7	Retail	7
522110	Commercial Banking	Nevada State Bank	7	Office_P	7
722511	Full-Service Restaurants	The Olive Garden	95	Food_Dr	95
722513	Limited-Service Restaurants	Wendy's	25	Food_Dr	25
512131	Motion Picture Theaters, ex. Drive-Ins	Galaxy Fandango	35	Other	35
451110	Sporting Goods Stores	Big 5 Sporting Goods	15	Retail	15
452990	All Other General Merchandise Stores	Big Lots	15	Retail	15
452112	Discount Department Stores	Ross	35	Retail	35
452112	Discount Department Stores	Burlington Coat Factory	45	Retail	45
722513	Limited-Service Restaurants	Taco Bell	25	Food_Dr	25
522292	Real Estate Credit	Greater Nevada Mortgage Services	15	Office_P	15
551114	Managing Offices	Greater Nevada Credit Union	25	Office_P	25
522130	Credit Unions	Greater Nevada Credit Union	15	Office_P	15
446191	Food (Health) Supplement Stores	General Nutrition Center	3	Retail	3
722515	Snack and Nonalcoholic Beverage Bars	Baskin Robbins CV Inc	15	Food_Dr	15
238221	Residential Plumbing/HVAC Contractors	Bonanza Plumbing LLC	1	Constru	1
561320	Temporary Help Services	Staff Augmenters	3	Office_P	3
721110	Hotels (except Casino Hotels) and Motels	Holiday Inn Express	15	Hotel_NG	15
448140	Family Clothing Stores	Rue21, Inc	15	Retail	15
721110	Hotels (except Casino Hotels) and Motels	Courtyard By Marriott	35	Hotel_NG	35
722513	Limited-Service Restaurants	Wingstop	15	Food_Dr	15
722513	Limited-Service Restaurants	Subway #11114	15	Food_Dr	15
722513	Limited-Service Restaurants	Mcdonald's	35	Food_Dr	35
236220	Commercial Building Construction	JCPenney Construction Services	3	Constru	3
452111	Department Stores, ex. Discount	JCPenny	75	Retail	75
442299	All Other Home Furnishings Stores	Tuesday Morning Inc	15	Retail	15

Douglas County/Carson City Regional Travel Demand Model

SIC_CODE	Industry	Trade_Name	Employment	Model_Category	Total_Emp
812112	Beauty Salons	Supercuts	7	Retail	7
522130	Credit Unions	Greater Nevada Credit Union	15	Office_P	15
522292	Real Estate Credit	Greater Nevada Mortgage Services	3	Office_P	3
551114	Managing Offices	Greater Nevada Credit Union	25	Office_P	25
221210	Natural Gas Distribution	Southwest Gas Corporation	85	Goods_P	85
713210	Casinos (except Casino Hotels)	Casino Fandango	350	Other	350
713290	Other Gambling Industries	Lucky's Race & Sports Book	3	Other	3
452112	Discount Department Stores	Kohls	55	Retail	55
722511	Full-Service Restaurants	International House Of Pancake	35	Food_Dr	35
522291	Consumer Lending	Wells Fargo Bank N A	3	Office_P	3
238131	Residential Framing Contractors	Capital City Construction	3	Constru	3
541213	Tax Preparation Services	H & R Block	7	Office_P	7
621493	Freestanding Emergency Medical Centers	Eye Surgery Center Of Nevada	3	Medical	3
722511	Full-Service Restaurants	Buffalo Wild Wings	55	Food_Dr	55
722513	Limited-Service Restaurants	Jimmy Johns	25	Food_Dr	25
713290	Other Gambling Industries	Dotty's	7	Other	7
423850	Service Industry Goods Merchant Whsle	West Coast Beauty Systems	3	Ware_H	3
722511	Full-Service Restaurants	Bamboo Garden	3	Food_Dr	3
444120	Paint and Wallpaper Stores	Sherwin-Williams Company	7	Retail	7
441110	New Car Dealers	Michael Hohl Motor Co	55	Retail	55
445110	Supermarkets and Other Grocery Stores	Raley's	75	Retail	75
447110	Gasoline Stations w/ Convenience Stores	7-Eleven Store 22629b	15	Retail	15
722410	Drinking Places (Alcoholic Beverages)	MJs Sports Bar	7	Food_Dr	7
722513	Limited-Service Restaurants	Jack in the Box	25	Food_Dr	25
238331	Residential Flooring Contractors	Atkins Classic Floors	3	Constru	3
561720	Janatorial Services	Mountain View Health	15	Other	15
621340	Offices of Specialty Therapists	Evergreen Mtn View Hlth & Rehab	3	Medical	3
623110	Nursing Care Facilities	Evergreen Mtn View Health & Re	150	Other	150
237120	Oil and Gas Pipeline Construction	Southwest Gas Corporation	35	Constru	35
238161	Residential Roofing Contractors	Fox Company	3	Constru	3
531190	Lessors of Other Real Estate Property	Lindsay Real Estate Investmt I	3	Office_P	3
423220	Home Furnishing Merchant Wholesalers	Ricks Floor Covering Inc	15	Ware_H	15
441110	New Car Dealers	Capital Ford Inc	85	Retail	85
484230	Other Specialized Trucking, Long-Dist	Hertz Corp	3	Other	3
532111	Passenger Car Rental	Hertz Corp	3	Other	3
811121	Automotive Body and Interior Repair	Kustom Kreations	15	Retail	15

Douglas County/Carson City Regional Travel Demand Model

SIC_CODE	Industry	Trade_Name	Employment	Model_Category	Total_Emp
236118	Residential Remodelers	John Erle Daniels Construction	3	Constru	3
238321	Residential Painting Contractors	Joes Painting	3	Constru	3
811121	Automotive Body and Interior Repair	Gilson Auto Body Inc	25	Retail	25
441310	Automotive Parts and Accessories Stores	O'Reilly Auto Parts	15	Retail	15
441310	Automotive Parts and Accessories Stores	Autozone	15	Retail	15
454111	Electronic Shopping	Fab Quest	3	Retail	3
441320	Tire Dealers	Discount Tire Co	15	Retail	15
531190	Lessors of Other Real Estate Property	Carson City Mobile Home Park	3	Office_P	3
541940	Veterinary Services	Carson Tahoe Veterinary Hosp	15	Office_P	15
236115	New Single-Family Housing Construction	M & R Construction Corp	3	Constru	3
722511	Full-Service Restaurants	Applebee's Neighborhood Grill	45	Food_Dr	45
442110	Furniture Stores	Secan Corporation	3	Retail	3
531110	Lessors of Residential Buildings	Cherry Creek Apartments	3	Office_P	3
442110	Furniture Stores	J M Furniture Inc	25	Retail	25
531130	Miniwarehouses and Self-Storage Unit	E-Zee Mini Storage	3	Office_P	3
443141	Household Appliance Stores	Northern Nevada Appliance Outl	15	Retail	15
721110	Hotels (except Casino Hotels) and Motels	Mill House Inn Motel	3	Hotel_NG	3
238342	Nonresidential Tile/Terrazzo Contractors	Capital Tile & Stone	3	Constru	3
425120	Wholesale Trade Agents and Brokers	JG Sales & Marketing Inc	1	Other	1
425120	Wholesale Trade Agents and Brokers	Repcor	3	Other	3
561730	Landscaping Services	Vega Gardening Inc	3	Other	3
811191	Automotive Oil Change/Lubrication Shops	Jiffy Lube	7	Retail	7
238151	Residential Glass/Glazing Contractors	Fast Glass Inc.	7	Constru	7
811121	Automotive Body and Interior Repair	Impact Mobile Dent Repair Inc	3	Retail	3
524210	Insurance Agencies and Brokerages	Baijounas Insurance Agency	1	Office_P	1
238291	Other Residential Equipment Contractors	House of Drake Inc	1	Constru	1
811192	Car Washes	Sierra Car Spa	15	Retail	15
451110	Sporting Goods Stores	America West Guns	3	Retail	3
524210	Insurance Agencies and Brokerages	Elizabeth Abarca-Angel Insuran	7	Office_P	7
541310	Architectural Services	Casey M Jones Architect Ltd	1	Office_P	1
441320	Tire Dealers	Les Schwab Tire Center	15	Retail	15
518210	Data Processing and Related Services	Online Advisors Inc	3	Office_P	3
441110	New Car Dealers	Carson Dodge-Chrysler Inc	65	Retail	65
531210	Offices of Real Estate Agents & Brokers	Charles Kitchen Realty	3	Office_P	3
812112	Beauty Salons	A Finer Image	1	Retail	1
453991	Tobacco Stores	Washoe One Stop	7	Retail	7

Douglas County/Carson City Regional Travel Demand Model

SIC_CODE	Industry	Trade_Name	Employment	Model_Category	Total_Emp
541613	Marketing Consulting Services	Miller Creative Solutions	3	Office_P	3
523920	Portfolio Management	Niemann Capital Mgmt Inc	3	Office_P	3
541110	Offices of Lawyers	Heaton Ltd	3	Office_P	3
551114	Managing Offices	Michael Hohl Administrative	25	Office_P	25
711510	Independent Artists/Writers/Performers	Changing Point, The	3	Other	3
524126	Direct Property and Casualty Insurers	AAA NCNU	7	Office_P	7
713940	Fitness and Recreational Sports Centers	Carson Colony Gym	3	Other	3
721110	Hotels (except Casino Hotels) and Motels	Super 8 Carson City	7	Hotel_NG	7
444190	Other Building Material Dealers	Meeks Building Center	25	Retail	25
453210	Office Supplies and Stationery Stores	High Sierra Business Systems	15	Retail	15
238321	Residential Painting Contractors	Randall C Pinnell	3	Constru	3
722511	Full-Service Restaurants	Grandma Hatties	25	Food_Dr	25
531210	Offices of Real Estate Agents & Brokers	Carson Properties Inc	3	Office_P	3
236220	Commercial Building Construction	Ruperts Precision Gemcutting	3	Constru	3
811121	Automotive Body and Interior Repair	Ruperts Auto Body LLC	7	Retail	7
238211	Residential Electrical Contractors	Caldera Electric	1	Constru	1
561720	Janatorial Services	Dirty Work	1	Other	1
624190	Other Individual and Family Services	Washoe Tribe of NV & Calif	7	Other	7
451120	Hobby, Toy, and Game Stores	Craft Market	15	Retail	15
721110	Hotels (except Casino Hotels) and Motels	Motel 6 Carson City	15	Hotel_NG	15
721110	Hotels (except Casino Hotels) and Motels	Americas Best Value Inn	7	Hotel_NG	7
441228	Motorcycle, ATV, and All Other Motor Vehicle	Michaels Cycle Works	15	Retail	15
454111	Electronic Shopping	Heartfelt Industries Inc	3	Retail	3
441110	New Car Dealers	Carson City Toyota Scion	95	Retail	95
541990	All Other Professional & Technical Svc	Coastal Management Solutions I	3	Office_P	3
236118	Residential Remodelers	Green Quality Services LLC	1	Constru	1
238222	Nonresidential Plumbing/HVAC Contractors	Anderson Heating & Air Condit	15	Constru	15
561730	Landscaping Services	Healthy Trees	7	Other	7
812112	Beauty Salons	Liaison Salon and Day Spa LLC	1	Retail	1
722513	Limited-Service Restaurants	Wendy's	25	Food_Dr	25
923130	Other Human Resource Program Admin	Divsion of Welfare & Supportive Svc	55	Office_G	55
721211	RV Parks and Campgrounds	Camp-N-Town RV Park	3	Other	3
531312	Nonresidential Property Managers	Northgate Plaza	3	Office_P	3
444190	Other Building Material Dealers	Western Nevada Supply Company	15	Retail	15
522110	Commercial Banking	Wells Fargo Bank N A	25	Office_P	25
523930	Investment Advice	Wells Fargo Advisors LLC	3	Office_P	3

Douglas County/Carson City Regional Travel Demand Model

SIC_CODE	Industry	Trade_Name	Employment	Model_Category	Total_Emp
624110	Child and Youth Services	Cassandra Le Favi	1	Other	1
484220	Other Specialized Trucking, Local	CML Distributors	3	Other	3
561730	Landscaping Services	Carson Valley Tree Care	3	Other	3
624120	Services for the Elderly and Disabled	Debra Tobias	1	Other	1
238221	Residential Plumbing/HVAC Contractors	All Air Control Inc	3	Constru	3
444220	Nursery, Garden & Farm Supply Stores	Greenhouse Garden Center	55	Retail	55
551114	Managing Offices	Best Western International Inc	1	Office_P	1
236118	Residential Remodelers	EB Homes	3	Constru	3
561730	Landscaping Services	Lake-Scaping	7	Other	7
339950	Sign Manufacturing	Fastsigns	7	Goods_P	7
442299	All Other Home Furnishings Stores	Sierra Hearth & Home	7	Retail	7
541340	Drafting Services	Design-Tek Inc	3	Office_P	3
524210	Insurance Agencies and Brokerages	Clay Murray Insurance Agency	3	Office_P	3
722511	Full-Service Restaurants	Mings Restaurant	7	Food_Dr	7
812910	Pet Care (except Veterinary) Services	Pawz Plus	3	Retail	3
532412	Other Heavy Machinery Rental and Leasing	Courson Equipment Co Inc	3	Other	3
238221	Residential Plumbing/HVAC Contractors	Capital Control Systems Inc	15	Constru	15
722515	Snack and Nonalcoholic Beverage Bars	Starbucks Coffee	15	Food_Dr	15
722515	Snack and Nonalcoholic Beverage Bars	Keva Juice	15	Food_Dr	15
561740	Carpet and Upholstery Cleaning Services	Floor Masters	3	Other	3
524298	All Other Insurance Related Activities	Silver State Health Insurance	15	Office_P	15
424490	Other Grocery Product Merchant Whsle	Forward Foods LLC	3	Ware_H	3
531210	Offices of Real Estate Agents & Brokers	Stephen F Lincoln CRS	3	Office_P	3
531210	Offices of Real Estate Agents & Brokers	RE/Max	3	Office_P	3
531210	Offices of Real Estate Agents & Brokers	Mary Jo Brummer	3	Office_P	3
541191	Title Abstract and Settlement Offices	Western Title Company LLC	3	Office_P	3
621511	Medical Laboratories	Cash Clinical Inc	7	Medical	7
561730	Landscaping Services	Property Care Management	3	Other	3
531190	Lessors of Other Real Estate Property	Parc De Maison Llc	3	Office_P	3
236118	Residential Remodelers	Ian Macsween Construction Co	3	Constru	3
531110	Lessors of Residential Buildings	Hoseit Management LLC	3	Office_P	3
531120	Lessors of Nonresidential Buildings	MHH Inc	3	Office_P	3
531130	Miniwarehouses and Self-Storage Unit	Colorado Storage Fairview Busi	3	Office_P	3
722511	Full-Service Restaurants	Dennys Restaurant	35	Food_Dr	35
444220	Nursery, Garden & Farm Supply Stores	S And W Feed & Supply Inc	7	Retail	7
711510	Independent Artists/Writers/Performers	Chops & Assoc Live Animation	1	Other	1

Douglas County/Carson City Regional Travel Demand Model

SIC_CODE	Industry	Trade_Name	Employment	Model_Category	Total_Emp
811118	Other Automotive Mechanical Repair	Precision Drivelines & Auto Re	3	Retail	3
561790	Other Services to Buildings & Dwellings	Circle Technologies Inc	25	Other	25
561730	Landscaping Services	Lawn Pro	15	Other	15
624410	Child Day Care Services	Lindas Nursery	3	Other	3
561990	All Other Support Services	GDW Corporation	1	Other	1
236118	Residential Remodelers	Desert in the Mountains Llc	1	Constru	1
236118	Residential Remodelers	HPF Enterprises Llc	3	Constru	3
551114	Managing Offices	Gold Label Management Co Inc	1	Office_P	1
336413	Other Aircraft Parts and Equipment	DJM Mfg Inc	3	Goods_P	3
541940	Veterinary Services	V&T Pet Clinic LLC	7	Office_P	7
517110	Wired Telecommunications Carriers	AT T Services Inc	3	Office_P	3
517110	Wired Telecommunications Carriers	Nevada Bell Telephone Co	15	Office_P	15
484230	Other Specialized Trucking, Long-Dist	B&M Express LLC	3	Other	3
493110	General Warehousing and Storage	Source Interlink Distributors LLC	7	Ware_H	7
238211	Residential Electrical Contractors	Hettrick Electric	15	Constru	15
811310	Commercial Machinery Repair/Maintenance	Rons Refrigeration	7	Retail	7
561730	Landscaping Services	Proscape Landscaping	7	Other	7
238221	Residential Plumbing/HVAC Contractors	Fallon Heating & Air Condition	15	Constru	15
611610	Fine Arts Schools	Ayakos Dance Studio	3	School	3
238171	Residential Siding Contractors	Carson Home Improvements	3	Constru	3
713990	All Other Amusement and Recreation Ind	Tip Top Amusement Co Inc	7	Other	7
515112	Radio Stations	Kgvm Radio	15	Office_P	15
812112	Beauty Salons	Freestyle Hair Design Inc	3	Retail	3
339950	Sign Manufacturing	Alpine Signs and Glass	3	Goods_P	3
923120	Administration of Public Health Programs	Public and Behavioral Health	35	Office_G	35
713940	Fitness and Recreational Sports Centers	Nevada Fitness	15	Other	15
812990	All Other Personal Services	Peak Performance Personal Trai	7	Other	7
812331	Linen Supply	ALSCO - American Linen	65	Retail	65
236220	Commercial Building Construction	South Carson Self Storage	3	Constru	3
531130	Miniwarehouses and Self-Storage Unit	South Carson Self Storage/Offi	3	Office_P	3
541512	Computer Systems Design Services	Xogenous Ltd LLC	7	Office_P	7
561599	All Other Travel Arrangement Services	Ticketview	15	Office_P	15
926150	Licensing/Regulating Commercial Sectors	Financial Institutions Division	3	Office_G	3
926150	Licensing/Regulating Commercial Sectors	Real Estate Division	7	Office_G	7
923120	Administration of Public Health Programs	Public And Behavioral Health	15	Office_G	15
926150	Licensing/Regulating Commercial Sectors	Labor Commission	7	Office_G	7

Douglas County/Carson City Regional Travel Demand Model

SIC_CODE	Industry	Trade_Name	Employment	Model_Category	Total_Emp
238131	Residential Framing Contractors	Second Generation Builders	7	Constru	7
541219	Other Accounting Services	Robin Hood Tax Services	3	Office_P	3
561320	Temporary Help Services	Labormax Staffing	25	Office_P	25
813920	Professional Organizations	Ormsby County Education Assoc	7	Office_P	7
454111	Electronic Shopping	Parts on Net	3	Retail	3
524210	Insurance Agencies and Brokerages	Creelman Insurance Svcs Inc	7	Office_P	7
812199	Other Personal Care Services	Santa Cruz Tanning Co	3	Retail	3
541690	Other Technical Consulting Services	Thomas E Gesick Inc	3	Office_P	3
621310	Offices of Chiropractors	Thomas H Dudley Dc	3	Medical	3
624120	Services for the Elderly and Disabled	Advanced Home Health Care	65	Other	65
561612	Security Guards and Patrol Services	High Sierra Patrol Inc	15	Other	15
813910	Business Associations	Nevada Rural Water Association	15	Office_P	15
442110	Furniture Stores	Mattress King Inc	3	Retail	3
453998	Store Retailers Not Specified Elsewhere	Hot Spring Spas	7	Retail	7
524210	Insurance Agencies and Brokerages	Lundeen and Associates Llc	3	Office_P	3
444190	Other Building Material Dealers	LED Light Inc, The	7	Retail	7
611110	Elementary and Secondary Schools	Silver State Charter School	7	School	7
446110	Pharmacies and Drug Stores	CVS Rx Services Inc	3	Retail	3
446110	Pharmacies and Drug Stores	Nevada Cvs Pharmacy Llc	15	Retail	15
453210	Office Supplies and Stationery Stores	Office Depot	15	Retail	15
722511	Full-Service Restaurants	Qs Steaks Bar-B-Que & Salads	15	Food_Dr	15
444110	Home Centers	Lowe S Home Centers LLC	150	Retail	150
453910	Pet and Pet Supplies Stores	Petsmart Inc	25	Retail	25
712110	Museums	Museums and History Division	15	Other	15
445310	Beer, Wine, and Liquor Stores	Fairview Smoke & Liquor LLC	3	Retail	3
339920	Sporting & Athletic Goods Manufacturing	UCS Spirit	15	Goods_P	15
423440	Other Commercial Equip Merchant Whsle	LED Inc	3	Ware_H	3
541110	Offices of Lawyers	Day R Williams Attorney @ Law	3	Office_P	3
541512	Computer Systems Design Services	Gnomon Inc	7	Office_P	7
238321	Residential Painting Contractors	Mastercraft Painting & Decorating	7	Constru	7
238911	Residential Site Preparation Contractors	Environmental Protection Servi	3	Constru	3
441228	Motorcycle, ATV, and All Other Motor Vehicle	Turnkey UTV LLC	7	Retail	7
811111	General Automotive Repair	Auto Techz	3	Retail	3
424810	Beer and Ale Merchant Wholesalers	Capital Beverages Inc	35	Ware_H	35
332813	Electroplating/Anodizing/Coloring Metal	All Metals Processing Company	7	Goods_P	7
423120	New Motor Vehicle Part Merchant Whsle	Snap-On Logistics Company	75	Ware_H	75

Douglas County/Carson City Regional Travel Demand Model

SIC_CODE	Industry	Trade_Name	Employment	Model_Category	Total_Emp
541512	Computer Systems Design Services	Cyberdefenses Inc	3	Office_P	3
541990	All Other Professional & Technical Svc	Odyssey-TCI JV LLC	1	Office_P	1
928110	National Security	Dept of Defense	150	Office_G	150
928110	National Security	Adjutant General & Natl Guard	35	Office_G	35
541611	Administrative Management Consulting Svc	Systems Plus Inc	1	Office_P	1
541990	All Other Professional & Technical Svc	Military Personnel Svcs Corp	15	Office_P	15
561320	Temporary Help Services	Sterling Medical Corporation	15	Office_P	15
624190	Other Individual and Family Services	Skyline Ultd Inc	3	Other	3
237120	Oil and Gas Pipeline Construction	Southwest Administrators Inc	150	Constru	150
519120	Libraries and Archives	General Services	15	Office_G	15
922120	Police Protection	Investigation Division	3	Office_G	3
922190	Other Justice and Safety Activities	Emergency Management	25	Office_G	25
924120	Administration of Conservation Programs	Forestry Division	35	Office_G	35
561410	Document Preparation Services	Ikun LLC	3	Office_P	3
551114	Managing Offices	Desert Fire Industries	1	Office_P	1
452990	All Other General Merchandise Stores	C-A-L Ranch Stores	15	Retail	15
611511	Cosmetology and Barber Schools	Carson City Beauty Academy	1	School	1
423720	Plumbing Goods Merchant Wholesalers	Record Supply Company	3	Ware_H	3
334513	Industrial Process Variable Instruments	Sierra Control Systems Inc	1	Goods_P	1
334513	Industrial Process Variable Instruments	Sierra Controls Llc	25	Goods_P	25
511110	Newspaper Publishers	Nevada Appeal	1	Office_P	1
511110	Newspaper Publishers	Nevada Appeal	65	Office_P	65
551114	Managing Offices	Swift Management Inc	65	Office_P	65
332439	Other Metal Container Manufacturing	Carson Valley Welding	3	Goods_P	3
453310	Used Merchandise Stores	Sams T.V & Appliance	3	Retail	3
238992	All Other Nonresidential Trade Contrs	Armac Construction Llc	15	Constru	15
334412	Bare Printed Circuit Board Manufacturing	Thermoptics Inc	7	Goods_P	7
336310	Motor Vehicle Gasoline Engine and Engine Part	Erson Cams	3	Goods_P	3
424610	Plastics Material Merchant Wholesalers	Polymer Plastics Company LC	7	Ware_H	7
518210	Data Processing and Related Services	Offsite Data Depot LLC	3	Office_P	3
813910	Business Associations	Carson City Chamber of Commerc	3	Office_P	3
541110	Offices of Lawyers	BH Consulting LLC	1	Office_P	1
812210	Funeral Homes and Funeral Services	Fitzhenrys Funeral Home	15	Other	15
923120	Administration of Public Health Programs	Centers for Disease Control & Preve	3	Office_G	3
924110	Air, Water and Waste Program Admin	Environmental Protection Agency	1	Office_G	1
221122	Electric Power Distribution	NV Energy	45	Goods_P	45

Douglas County/Carson City Regional Travel Demand Model

SIC_CODE	Industry	Trade_Name	Employment	Model_Category	Total_Emp
236115	New Single-Family Housing Construction	Jones Construction Co	3	Constru	3
236118	Residential Remodelers	JMA Construction Co Inc	7	Constru	7
327110	Pottery, Ceramics, and Plumbing Fixture Manuf	Allevery HR Inc	1	Goods_P	1
334419	Other Electronic Component Manufacturing	Raven Technology Group LLC	1	Goods_P	1
424120	Office Supplies Merchant Wholesalers	Staples the Office Superstore	1	Ware_H	1
424120	Office Supplies Merchant Wholesalers	Staples Contract Commercial	7	Ware_H	7
444190	Other Building Material Dealers	Daves Supply Inc	3	Retail	3
515112	Radio Stations	KNIS Radio/Pilgrim Radio	7	Office_P	7
517210	Wireless Telecommunications Carriers	Sprint Corp	3	Office_P	3
541110	Offices of Lawyers	Law Offices of Edward Bernard	3	Office_P	3
624410	Child Day Care Services	Sierra Vista Childrens Academy	15	Other	15
713910	Golf Courses and Country Clubs	Empire Ranch Golf Course LLC	35	Other	35
722410	Drinking Places (Alcoholic Beverages)	Blue Bull	7	Food_Dr	7
811212	Computer and Office Machine Repair	Remote Computers Inc	1	Retail	1
999999	Unknown Industry	NVImport Corp	3	Other	3
447110	Gasoline Stations w/ Convenience Stores	Capitol Shell Station	7	Retail	7
722515	Snack and Nonalcoholic Beverage Bars	Dutch Bros Coffee	15	Food_Dr	15
451110	Sporting Goods Stores	Sportman's Warehouse	55	Retail	55
561720	Janatorial Services	Kellermeyer Building Services	7	Other	7
621111	Offices of Physicians, ex. Mental Health	Nevada Cancer Center	15	Medical	15
339950	Sign Manufacturing	Vital Signs	7	Goods_P	7
541110	Offices of Lawyers	Scott Scherer PC	3	Office_P	3
541511	Custom Computer Programming Services	Atlas Web Development Inc	3	Office_P	3
238341	Residential Tile/Terrazzo Contractors	Rubicon Granite Co	15	Constru	15
921190	Other General Government Support	Enterprise IT Services	15	Office_G	15
922120	Police Protection	Highway Patrol	35	Office_G	35
922130	Legal Counsel and Prosecution	Attorney General's Office	7	Office_G	7
922190	Other Justice and Safety Activities	Department of Public Safety	25	Office_G	25
926120	Transportation Program Administration	Department of Motor Vehicles	350	Office_G	350
541511	Custom Computer Programming Services	Ajel Technologies Inc	1	Office_P	1
561320	Temporary Help Services	Soft Labsna Inc	3	Office_P	3
551114	Managing Offices	Datatronics Romoland Inc	3	Office_P	3
448140	Family Clothing Stores	Bealls	25	Retail	25
522292	Real Estate Credit	Rural Housing Service	15	Office_P	15
444190	Other Building Material Dealers	Tile Outlet Always in Stock	3	Retail	3
813910	Business Associations	Builders Assn of Western NV	3	Office_P	3

Douglas County/Carson City Regional Travel Demand Model

SIC_CODE	Industry	Trade_Name	Employment	Model_Category	Total_Emp
923130	Other Human Resource Program Admin	Rehabilitation Division	15	Office_G	15
923130	Other Human Resource Program Admin	DETR Administrative Services	25	Office_G	25
541511	Custom Computer Programming Services	NIC Info Tek Inc	1	Office_P	1
448120	Women's Clothing Stores	Bellissimo	3	Retail	3
722513	Limited-Service Restaurants	Carl's Jr. Restaurant	25	Food_Dr	25
541620	Environmental Consulting Services	K2 Environmental LLC	1	Office_P	1
721110	Hotels (except Casino Hotels) and Motels	Round House Inn	7	Hotel_NG	7
922120	Police Protection	Investigation Division	3	Office_G	3
922120	Police Protection	Highway Patrol	15	Office_G	15
425120	Wholesale Trade Agents and Brokers	Nawgan Products Llc	1	Other	1
454111	Electronic Shopping	Fit 4 Maui	3	Retail	3
722511	Full-Service Restaurants	Lilys China Bistro	3	Food_Dr	3
812210	Funeral Homes and Funeral Services	Walton Carson Chapel	7	Other	7
236115	New Single-Family Housing Construction	Quil Construction LLC	1	Constru	1
451130	Sewing, Needlework & Piece Goods Stores	Jo-Ann Fabrics & Crafts	15	Retail	15
923130	Other Human Resource Program Admin	Employment Security Division	85	Office_G	85
922130	Legal Counsel and Prosecution	Attorney General's Office	7	Office_G	7
926120	Transportation Program Administration	Department of Transportation	750	Office_G	750
812320	Drycleaning and Laundry Services	Bobby Pages Dry Cleaners &	25	Retail	25
722513	Limited-Service Restaurants	Charleys Grilled Subs	3	Food_Dr	3
722513	Limited-Service Restaurants	Thai Thai	1	Food_Dr	1
443142	Electronics Stores	Radioshack Corp	3	Retail	3
722513	Limited-Service Restaurants	Super Burrito	7	Food_Dr	7
238212	Nonresidential Electrical Contractors	Anything Electric LLC	3	Constru	3
453220	Gift, Novelty, and Souvenir Stores	Forever Designs/Sierra Gifts	7	Retail	7
722513	Limited-Service Restaurants	Little Caesars Pizza	25	Food_Dr	25
624110	Child and Youth Services	Amy Garland	3	Other	3
448140	Family Clothing Stores	Boot Barn	7	Retail	7
722513	Limited-Service Restaurants	Paul Schats Bakery	35	Food_Dr	35
238211	Residential Electrical Contractors	Silver State Electric	3	Constru	3
624190	Other Individual and Family Services	Community Pregnancy Ctr of CC	3	Other	3
722511	Full-Service Restaurants	Franciscos Carson City	15	Food_Dr	15
531110	Lessors of Residential Buildings	Griffin House	3	Office_P	3
722513	Limited-Service Restaurants	Arbys Carson City	15	Food_Dr	15
621111	Offices of Physicians, ex. Mental Health	Carson Dermatology Assoc &Skin	15	Medical	15
491110	Postal Service	USPS Carson City Po	85	Other	85

Douglas County/Carson City Regional Travel Demand Model

SIC_CODE	Industry	Trade_Name	Employment	Model_Category	Total_Emp
236115	New Single-Family Housing Construction	Pat Findley Building Contracto	1	Constru	1
531320	Offices of Real Estate Appraisers	Daniel A Leck Inc	3	Office_P	3
621512	Diagnostic Imaging Centers	Nascorp	3	Medical	3
523120	Securities Brokerage	Jones, Edward D & Company	3	Office_P	3
531210	Offices of Real Estate Agents & Brokers	Kellie Roberts Ltd	3	Office_P	3
531210	Offices of Real Estate Agents & Brokers	Realty Executives Nevadas Cho	7	Office_P	7
532111	Passenger Car Rental	Enterprise Leasing Company	7	Other	7
541110	Offices of Lawyers	Handelin Law LLC	3	Office_P	3
541110	Offices of Lawyers	Richard S Staub Attorney	3	Office_P	3
722511	Full-Service Restaurants	Red's Old 395 Grill	75	Food_Dr	75
238321	Residential Painting Contractors	American Pride Painting	3	Constru	3
921130	Public Finance Activities	Deferred Compensation	3	Office_G	3
531120	Lessors of Nonresidential Buildings	Rjs Properties Inc	3	Office_P	3
541219	Other Accounting Services	Ken Brown Ltd	3	Office_P	3
561990	All Other Support Services	Integrated Health Management S	3	Other	3
524210	Insurance Agencies and Brokerages	Janet Staub	3	Office_P	3
541519	Other Computer Related Services	FX Consulting Inc	1	Office_P	1
425120	Wholesale Trade Agents and Brokers	American Casting Company	3	Other	3
721110	Hotels (except Casino Hotels) and Motels	Pioneer Motel	3	Hotel_NG	3
721120	Casino Hotels	Carson Station Hotel Casino	95	Hotel_G	95
921190	Other General Government Support	Historic Preservation	7	Office_G	7
924120	Administration of Conservation Programs	Conservation Districts	3	Office_G	3
924120	Administration of Conservation Programs	Wildlife Department	3	Office_G	3
531311	Residential Property Managers	Henry S Miller Realty Manageme	3	Office_P	3
713290	Other Gambling Industries	Carson Station Race & Sports Book	3	Other	3
238211	Residential Electrical Contractors	Dek Electric Inc	7	Constru	7
531110	Lessors of Residential Buildings	Saliman Manor Apartments	3	Office_P	3
453910	Pet and Pet Supplies Stores	Sierra Le Bone	3	Retail	3
721110	Hotels (except Casino Hotels) and Motels	Plaza Hotel	15	Hotel_NG	15
541611	Administrative Management Consulting Svc	LSM Government Financial Manag	3	Office_P	3
561740	Carpet and Upholstery Cleaning Services	Bruces Carpet Cleaning	3	Other	3
541211	Offices of Certified Public Accountants	John F Gardner CPA Inc	3	Office_P	3
811212	Computer and Office Machine Repair	Debug Computer Inc	15	Retail	15
722410	Drinking Places (Alcoholic Beverages)	Timbers, The	3	Food_Dr	3
236118	Residential Remodelers	Roy Houghton Construction	3	Constru	3
541512	Computer Systems Design Services	RS International Inc	3	Office_P	3

Douglas County/Carson City Regional Travel Demand Model

SIC_CODE	Industry	Trade_Name	Employment	Model_Category	Total_Emp
541613	Marketing Consulting Services	Sales Force Automation Inc	1	Office_P	1
561990	All Other Support Services	Resident Agents of Nevada Inc	3	Other	3
541219	Other Accounting Services	John R Whitesides EA	3	Office_P	3
524292	Third Party Admin of Insurance Funds	Pro Group Captive Management S	7	Office_P	7
524292	Third Party Admin of Insurance Funds	Pro Group Management Inc	45	Office_P	45
541690	Other Technical Consulting Services	PGM Safety Services Llc	15	Office_P	15
447110	Gasoline Stations w/ Convenience Stores	AM-PM #250	15	Retail	15
561330	Professional Employer Organizations	A2Z Staffing LLC	45	Office_P	45
722513	Limited-Service Restaurants	Artisans Cafe, The	3	Food_Dr	3
621210	Offices of Dentists	Dream Dentistry Inc	3	Medical	3
517110	Wired Telecommunications Carriers	Pyramid.Net	3	Office_P	3
453110	Florists	Flower Bucket Florist	3	Retail	3
814110	Private Households	Maud Naroll	3	Other	3
811192	Car Washes	Turbo Car Wash	3	Retail	3
561730	Landscaping Services	Empire Landscape Maintenance	1	Other	1
236118	Residential Remodelers	Tom Peters Construction Inc	7	Constru	7
722410	Drinking Places (Alcoholic Beverages)	Ormsby House Hotel/Casino	7	Food_Dr	7
812910	Pet Care (except Veterinary) Services	A Pawsitive Image Grooming Sal	3	Retail	3
238222	Nonresidential Plumbing/HVAC Contractors	Capital Fire Protection LLC	3	Constru	3
621210	Offices of Dentists	Elizabeth Park DDS	1	Medical	1
621210	Offices of Dentists	Gary C Aglietti Dmd Ltd	3	Medical	3
621210	Offices of Dentists	Park Dental Management Company	15	Medical	15
621210	Offices of Dentists	Sierra Cosmetic Dental Center	7	Medical	7
922140	Correctional Institutions	Department of Corrections	150	Office_G	150
926120	Transportation Program Administration	Department of Motor Vehicles	3	Office_G	3
541110	Offices of Lawyers	Law Office of Steven A Wilson	3	Office_P	3
541820	Public Relations Agencies	Larry W Bennett & Assoc Ltd	1	Office_P	1
447110	Gasoline Stations w/ Convenience Stores	Jacksons Food Stores	7	Retail	7
621610	Home Health Care Services	Accessible Space	7	Other	7
623990	Other Residential Care Facilities	Accessible Space, Inc	7	Other	7
531311	Residential Property Managers	S S Investments Ltd	1	Office_P	1
445310	Beer, Wine, and Liquor Stores	JM Discount Liquor	3	Retail	3
531130	Miniwarehouses and Self-Storage Unit	Safe Storage	3	Office_P	3
923110	Administration of Education Programs	Department of Education	95	Office_G	95
541511	Custom Computer Programming Services	Trinuc LLC	3	Office_P	3
922110	Courts	Judicial Branch	15	Office_G	15

Douglas County/Carson City Regional Travel Demand Model

SIC_CODE	Industry	Trade_Name	Employment	Model_Category	Total_Emp
921190	Other General Government Support	State Library and Archives	15	Office_G	15
812310	Coin-Operated Laundries and Drycleaners	Laundry Lounge Corporation	3	Retail	3
621210	Offices of Dentists	Landmark 7 Inc	1	Medical	1
621210	Offices of Dentists	First Care Dental	7	Medical	7
999999	Unknown Industry	Golden Desert Inc	1	Other	1
813410	Civic and Social Organizations	Carson Aerie 1006 Fraternal Or	3	Office_P	3
621320	Offices of Optometrists	Thomas J Gibbons Od	3	Medical	3
813910	Business Associations	Retail Association of Nevada	7	Office_P	7
531210	Offices of Real Estate Agents & Brokers	Buyers Realty at Tahoe Inc	3	Office_P	3
541511	Custom Computer Programming Services	Service Order Software	1	Office_P	1
523991	Trust, Fiduciary, and Custody Activities	Fiduciary Services of NV LLC	3	Office_P	3
621210	Offices of Dentists	G Larry Leonakis	7	Medical	7
921120	Legislative Bodies	Legislative Counsel Bureau	250	Office_G	250
624410	Child Day Care Services	Nancys House Daycare	3	Other	3
561492	Court Reporting and Stenotype Services	Capitol Reporters	3	Office_P	3
238211	Residential Electrical Contractors	Foothill Electric Co Inc	3	Constru	3
481211	Nonscheduled Air Passenger Chartering	Pegasus Elite Aviation Inc	3	Other	3
512110	Motion Picture and Video Production	Kuzma Inc	1	Office_P	1
517110	Wired Telecommunications Carriers	JB Services Inc	3	Office_P	3
541199	All Other Legal Services	A+ Paralegals Inc	1	Office_P	1
812112	Beauty Salons	Marys About Face & Body Inc	3	Retail	3
541110	Offices of Lawyers	Kaempfer Crowell Renshaw Gronauer &	7	Office_P	7
624190	Other Individual and Family Services	Capital City Circles Initiative	3	Other	3
813990	Other Similar Organizations	Carson Park Condominium Homeow	3	Office_P	3
531210	Offices of Real Estate Agents & Brokers	Sandra K Smith LLC	3	Office_P	3
813910	Business Associations	Nevada League of Cities	3	Office_P	3
722513	Limited-Service Restaurants	Comma Coffee	15	Food_Dr	15
541519	Other Computer Related Services	JFG Systems Inc	7	Office_P	7
924120	Administration of Conservation Programs	Bureau of Reclamation	35	Office_G	35
541990	All Other Professional & Technical Svc	Heath Consultants Inc	3	Office_P	3
561990	All Other Support Services	Resident Agency National Incor	1	Other	1
236118	Residential Remodelers	Kindred Construction Company	3	Constru	3
813910	Business Associations	Nevada Assn of Counties	3	Office_P	3
722511	Full-Service Restaurants	Firkin & Fox	35	Food_Dr	35
561990	All Other Support Services	One Call Locators Ltd	3	Other	3
813910	Business Associations	Sierra Nevada Association of R	3	Office_P	3

Douglas County/Carson City Regional Travel Demand Model

SIC_CODE	Industry	Trade_Name	Employment	Model_Category	Total_Emp
561320	Temporary Help Services	Industrial Staffing Service In	3	Office_P	3
561320	Temporary Help Services	Aureus Radiology LLC	3	Office_P	3
921190	Other General Government Support	Enterprise IT Services	65	Office_G	65
541511	Custom Computer Programming Services	I Q Software Development	1	Office_P	1
454111	Electronic Shopping	Natural Health Consultants Inc	1	Retail	1
561990	All Other Support Services	Nevada Business Center LLC	3	Other	3
524210	Insurance Agencies and Brokerages	Bibee & Associates Inc	3	Office_P	3
541211	Offices of Certified Public Accountants	Mary K Mangione CPA PC	3	Office_P	3
541214	Payroll Services	Sierra Payroll Services	3	Office_P	3
923110	Administration of Education Programs	Public Charter School Authority	3	Office_G	3
923130	Other Human Resource Program Admin	Employment Security Division	7	Office_G	7
923130	Other Human Resource Program Admin	DETR Administrative Services	75	Office_G	75
541512	Computer Systems Design Services	I3Tech Data Solutions Inc	3	Office_P	3
541110	Offices of Lawyers	Badger & Baker Attorneys at Law	3	Office_P	3
541211	Offices of Certified Public Accountants	Allbritten/Slates CPAS LLC	3	Office_P	3
541110	Offices of Lawyers	Peter B Jaquette Attorney	3	Office_P	3
722511	Full-Service Restaurants	Mom & Pops Diner Inc	15	Food_Dr	15
621391	Offices of Podiatrists	Steven R Kubel DPM	3	Medical	3
621420	Outpatient Mental Health Centers	Carson City Comm Counseling Ct	15	Medical	15
453310	Used Merchandise Stores	Hanifins Antiques	3	Retail	3
541211	Offices of Certified Public Accountants	Bullis and Company CPAS LLC	7	Office_P	7
813319	Other Social Advocacy Organizations	Pets of the Homeless	3	Office_P	3
621420	Outpatient Mental Health Centers	Carol J Aalbers PhD LLC	7	Medical	7
722410	Drinking Places (Alcoholic Beverages)	Bella Fiore Wines	3	Food_Dr	3
921190	Other General Government Support	Risk Management Division	7	Office_G	7
524292	Third Party Admin of Insurance Funds	CCMSI	7	Office_P	7
541612	Human Resource Consulting Services	Pooling Resources Inc	7	Office_P	7
561110	Office Administrative Services	Public Agency Risk Mgmt Svcs	7	Office_P	7
531210	Offices of Real Estate Agents & Brokers	Nai Alliance Carson City	3	Office_P	3
238322	Nonresidential Painting Contractors	Adam Roe Painting Inc	1	Constru	1
541211	Offices of Certified Public Accountants	Knapp Cook & Williams Ltd	7	Office_P	7
561990	All Other Support Services	Capitol Corporate Services Inc	3	Other	3
541511	Custom Computer Programming Services	RDM Infinity LLC	3	Office_P	3
921190	Other General Government Support	State Public Works Division	7	Office_G	7
541110	Offices of Lawyers	James J Rankl Attorney at Law	3	Office_P	3
541110	Offices of Lawyers	Wayne S Chimarusti Attorney at	3	Office_P	3

Douglas County/Carson City Regional Travel Demand Model

SIC_CODE	Industry	Trade_Name	Employment	Model_Category	Total_Emp
623312	Homes for the Elderly	Ormsby Heights Residential Car	15	Other	15
541219	Other Accounting Services	Ecstasis LLC	3	Office_P	3
238161	Residential Roofing Contractors	Northern Nevada Roofing Specialist	1	Constru	1
541511	Custom Computer Programming Services	HCLAmerica Inc	7	Office_P	7
711310	Promoters with Facilities	Brewery Arts Center	3	Other	3
541330	Engineering Services	Stanka Consulting Ltd	7	Office_P	7
519120	Libraries and Archives	State Library and Archives	25	Office_G	25
921190	Other General Government Support	Enterprise IT Services	35	Office_G	35
921190	Other General Government Support	Div of Human Resource Mgmt	35	Office_G	35
921190	Other General Government Support	Fleet Services Division	7	Office_G	7
236115	New Single-Family Housing Construction	Coursey Custom Builders Inc	3	Constru	3
924120	Administration of Conservation Programs	Commission on Mineral Resource	15	Office_G	15
926150	Licensing/Regulating Commercial Sectors	Industrial Relations Division	35	Office_G	35
611110	Elementary and Secondary Schools	Carson City School District	1250	School	1250
551114	Managing Offices	Carson City School District	3	Office_P	3
921190	Other General Government Support	State Public Works Division	3	Office_G	3
922130	Legal Counsel and Prosecution	Attorney General's Office	150	Office_G	150
519110	News Syndicates	Associated Press in the State	3	Office_P	3
813910	Business Associations	Nevada Press Association Inc	3	Office_P	3
921110	Executive Offices	Lieutenant Governor's Office	3	Office_G	3
921110	Executive Offices	Governor's Office	15	Office_G	15
921110	Executive Offices	Secretary of State's Office	35	Office_G	35
921130	Public Finance Activities	Department Of Administration	1	Office_G	1
921130	Public Finance Activities	Unclaimed Property	3	Office_G	3
921130	Public Finance Activities	Treasurer's Office	15	Office_G	15
921130	Public Finance Activities	Controller's Office	35	Office_G	35
922120	Police Protection	Capital Police	25	Office_G	25
923110	Administration of Education Programs	Millennium Scholarship	3	Office_G	3
541110	Offices of Lawyers	Taggart & Taggart Ltd	7	Office_P	7
541613	Marketing Consulting Services	Likeacoupon Inc	3	Office_P	3
561110	Office Administrative Services	Capital City Management	3	Office_P	3
561990	All Other Support Services	State Agent & Transfer Syndica	3	Other	3
711510	Independent Artists/Writers/Performers	Greg & Steve Productions Inc	1	Other	1
922120	Police Protection	Highway Patrol	3	Office_G	3
921190	Other General Government Support	Purchasing Division	25	Office_G	25
924120	Administration of Conservation Programs	Wildlife Department	3	Office_G	3

Douglas County/Carson City Regional Travel Demand Model

SIC_CODE	Industry	Trade_Name	Employment	Model_Category	Total_Emp
921110	Executive Offices	Secretary of State's Office	15	Office_G	15
921130	Public Finance Activities	Internal Audits Division	15	Office_G	15
921130	Public Finance Activities	Department of Administration	25	Office_G	25
921190	Other General Government Support	Div of Human Resource Mgmt	25	Office_G	25
921190	Other General Government Support	Administrative Services Division	35	Office_G	35
925120	Urban and Rural Development Admin	State Public Works Division	55	Office_G	55
523120	Securities Brokerage	Jones, Edward D & Company	3	Office_P	3
236220	Commercial Building Construction	Facilities Management Inc	7	Constru	7
531312	Nonresidential Property Managers	Nai Alliance	3	Office_P	3
722515	Snack and Nonalcoholic Beverage Bars	Capital Coffee LLC	3	Food_Dr	3
813930	Labor Unions & Other Labor Organizations	AFSCME Local 4041	3	Office_P	3
621310	Offices of Chiropractors	Kona Chiropractic LLC	3	Medical	3
541110	Offices of Lawyers	Norman J Azevedo Atty at Law	3	Office_P	3
541110	Offices of Lawyers	Allison Whittle Joffe A Profe	7	Office_P	7
541690	Other Technical Consulting Services	Phoenix General & Health Svcs	3	Office_P	3
921110	Executive Offices	Secretary of State's Office	45	Office_G	45
551114	Managing Offices	Services Group Inc	3	Office_P	3
541330	Engineering Services	Turnipseed Engineering Ltd	3	Office_P	3
813312	Environment & Conservation Organizations	Western Resource Advocates	3	Office_P	3
621111	Offices of Physicians, ex. Mental Health	VIP Medical Access	3	Medical	3
922110	Courts	Judicial Branch	150	Office_G	150
926150	Licensing/Regulating Commercial Sectors	Foreclosure Mediation Program	3	Office_G	3
921140	Executive & Legislative Offices Combined	City of Carson City	750	Office_G	750
522110	Commercial Banking	Wells Fargo Bank N A	15	Office_P	15
921110	Executive Offices	Secretary of State's Office	7	Office_G	7
453991	Tobacco Stores	Nevada Vapor Supply	3	Retail	3
561320	Temporary Help Services	Fleet Staff Inc	1	Office_P	1
541110	Offices of Lawyers	Kay Ellen Armstrong Attorney	3	Office_P	3
621210	Offices of Dentists	Redrock Family Dental	7	Medical	7
621340	Offices of Specialty Therapists	Kristin Robison OTR/L	1	Medical	1
814110	Private Households	David A Tack	3	Other	3
531120	Lessors of Nonresidential Buildings	Sheerins Inc	3	Office_P	3
812112	Beauty Salons	Salon Chocolat	3	Retail	3
524210	Insurance Agencies and Brokerages	Meridian Insurance Services	15	Office_P	15
327991	Cut Stone & Stone Product Manufacturing	Stone Tech	3	Goods_P	3
722511	Full-Service Restaurants	Garibaldis Ristorante	7	Food_Dr	7

Douglas County/Carson City Regional Travel Demand Model

SIC_CODE	Industry	Trade_Name	Employment	Model_Category	Total_Emp
813910	Business Associations	Nevada Independent Insurance A	7	Office_P	7
722511	Full-Service Restaurants	High Sierra Brewing Co Inc	1	Food_Dr	1
722410	Drinking Places (Alcoholic Beverages)	Jimmy Gs	15	Food_Dr	15
523910	Miscellaneous Intermediation	BCB Ventures	1	Office_P	1
531120	Lessors of Nonresidential Buildings	V & T Management LLC	7	Office_P	7
541211	Offices of Certified Public Accountants	John C Cowee CPA	3	Office_P	3
522298	All Other Nondeposit Credit Intermediatn	Carson Jewelry & Loan Inc	7	Office_P	7
522310	Mortgage and Nonmortgage Loan Brokers	CTC Financial Inc	3	Office_P	3
454111	Electronic Shopping	Linesupplies Corp	3	Retail	3
561110	Office Administrative Services	Casita Inc	3	Office_P	3
721110	Hotels (except Casino Hotels) and Motels	Stewart Street Inn	3	Hotel_NG	3
531210	Offices of Real Estate Agents & Brokers	Sperry Van Ness/Gold Dust Comm'l	3	Office_P	3
722511	Full-Service Restaurants	Basil, The	7	Food_Dr	7
453991	Tobacco Stores	Carson Cigar Co, The	7	Retail	7
524210	Insurance Agencies and Brokerages	AFLAC	3	Office_P	3
531110	Lessors of Residential Buildings	Liepmann Properties LLC	3	Office_P	3
531210	Offices of Real Estate Agents & Brokers	GCbroker Inc	1	Office_P	1
533110	Lessors, Nonfinancial Intangible Assets	5 LLC	3	Office_P	3
541199	All Other Legal Services	Parasec	3	Office_P	3
541310	Architectural Services	Berger Hannafin Architecture L	3	Office_P	3
562910	Remediation Services	ABS Pathfinder Enterprises	1	Other	1
722511	Full-Service Restaurants	Sassafras	25	Food_Dr	25
541110	Offices of Lawyers	Geoffrey Roullard	3	Office_P	3
541330	Engineering Services	Resource Concepts Inc	45	Office_P	45
425120	Wholesale Trade Agents and Brokers	Rhino Safety Products LLC	1	Other	1
531210	Offices of Real Estate Agents & Brokers	KTW NV Llc	1	Office_P	1
541110	Offices of Lawyers	Rutledge Law Center Ltd	3	Office_P	3
722511	Full-Service Restaurants	KI Management LLC	3	Food_Dr	3
722513	Limited-Service Restaurants	Chicago Express	3	Food_Dr	3
236118	Residential Remodelers	Armor Building Corporation	3	Constru	3
722511	Full-Service Restaurants	Yangs Kitchen	7	Food_Dr	7
238162	Nonresidential Roofing Contractors	Summit American Inc	1	Constru	1
238912	Nonresidential Site Preparation Contrs	Cal-Nevada Precision Blasting	7	Constru	7
524210	Insurance Agencies and Brokerages	Fred Jones Insurance	3	Office_P	3
722410	Drinking Places (Alcoholic Beverages)	Mo & Sluggos Bar And Grill	7	Food_Dr	7
713210	Casinos (except Casino Hotels)	Carson Horseshoe Club	45	Other	45

Douglas County/Carson City Regional Travel Demand Model

SIC_CODE	Industry	Trade_Name	Employment	Model_Category	Total_Emp
722511	Full-Service Restaurants	Mustang Sallies Deuces Grill	3	Food_Dr	3
541110	Offices of Lawyers	Allison, Mackenzie Law Firm	25	Office_P	25
621111	Offices of Physicians, ex. Mental Health	Peter N Costa MD Ltd	3	Medical	3
813920	Professional Organizations	Nevada Justice Association	7	Office_P	7
541410	Interior Design Services	Lofty Expressions Inc	1	Office_P	1
926110	Administration of General Economic Prog	Commission on Tourism	35	Office_G	35
722410	Drinking Places (Alcoholic Beverages)	Old Globe Saloon Inc	3	Food_Dr	3
541219	Other Accounting Services	Physicians Receivables Mgmt LLC	3	Office_P	3
621340	Offices of Specialty Therapists	Hearing Care of Carson City Lt	3	Medical	3
621330	Offices of Mental Health Practitioners	Carson Professional Group	3	Medical	3
541110	Offices of Lawyers	Ernest E Adler Atty at Law	3	Office_P	3
541110	Offices of Lawyers	Robert G Johnston Attorney At	3	Office_P	3
541110	Offices of Lawyers	Charles M Kilpatrick Ltd	7	Office_P	7
541690	Other Technical Consulting Services	Device Concept Inc	1	Office_P	1
713210	Casinos (except Casino Hotels)	Cactus Jacks Senators Club	25	Other	25
531190	Lessors of Other Real Estate Property	Terry Inc	1	Office_P	1
236118	Residential Remodelers	CBM Construction	1	Constru	1
531110	Lessors of Residential Buildings	Senator Apartment LLC	3	Office_P	3
424330	Women's Clothing Merchant Wholesalers	Bani Bands	1	Ware_H	1
522298	All Other Nondeposit Credit Intermediatn	G-Force Enterprizes	3	Office_P	3
541330	Engineering Services	Parcom	1	Office_P	1
561410	Document Preparation Services	Corporate Svcs / Growth Coach	3	Office_P	3
814110	Private Households	Robert C McFadden Jr	3	Other	3
524210	Insurance Agencies and Brokerages	Larry Cross Insurance Services	3	Office_P	3
561492	Court Reporting and Stenotype Services	Sharp Reporting Services	3	Office_P	3
519130	Internet Publishing & Broadcasting and Web Se	Icentric Corporation	1	Office_P	1
541110	Offices of Lawyers	Smith & Harmer Ltd	3	Office_P	3
541712	Research and Development in the Physical, Eng	Upstream Technologies Inc	1	Office_P	1
711130	Musical Groups and Artists	Frazzy Frog Music Inc	1	Other	1
541211	Offices of Certified Public Accountants	Casey Neilon & Associates LLC	15	Office_P	15
713210	Casinos (except Casino Hotels)	Carson City Nugget	250	Other	250
713290	Other Gambling Industries	Carson Nugget Race & Sports Book	3	Other	3
522292	Real Estate Credit	Primelending	7	Office_P	7
541211	Offices of Certified Public Accountants	Kress K Cave CPA	3	Office_P	3
621399	Offices of Misc Health Practitioners	Sierra Acupuncture & Healing A	7	Medical	7
541330	Engineering Services	Sierra Engineering Inc	3	Office_P	3

Douglas County/Carson City Regional Travel Demand Model

SIC_CODE	Industry	Trade_Name	Employment	Model_Category	Total_Emp
923130	Other Human Resource Program Admin	Dept of Health & Human Services	15	Office_G	15
813930	Labor Unions & Other Labor Organizations	AFSCME	15	Office_P	15
621210	Offices of Dentists	Frederick T Young DMD Ltd	7	Medical	7
238392	Other Nonresidential Finishing Contrs	Mke Inc	1	Constru	1
561410	Document Preparation Services	Acacia Business Solutions	3	Office_P	3
425120	Wholesale Trade Agents and Brokers	Encinitas Foliage Imports Inc	3	Other	3
423940	Jewelry Merchant Wholesalers	Northern Nevada Coin	25	Ware_H	25
551114	Managing Offices	Test Equipment Corporation	3	Office_P	3
721110	Hotels (except Casino Hotels) and Motels	Nugget Motel	7	Hotel_NG	7
561720	Janatorial Services	Governor's Office	3	Other	3
922120	Police Protection	Highway Patrol	3	Office_G	3
712110	Museums	Museums and History Division	15	Other	15
561611	Investigation Services	Employer Lynx Inc	15	Office_P	15
621210	Offices of Dentists	Richard L Reich DDS Ltd	7	Medical	7
517110	Wired Telecommunications Carriers	Nevada Bell Telephone Co	7	Office_P	7
531120	Lessors of Nonresidential Buildings	Dgd Development Ltd Partnershi	3	Office_P	3
621210	Offices of Dentists	Capital City Dental Inc	7	Medical	7
447110	Gasoline Stations w/ Convenience Stores	Bobs Texaco Service	7	Retail	7
921190	Other General Government Support	Indian Affairs	15	Office_G	15
924120	Administration of Conservation Programs	Bureau of Land Mgmt	1	Office_G	1
924120	Administration of Conservation Programs	Ofc of the Secretary	3	Office_G	3
924120	Administration of Conservation Programs	US Geological Survey	45	Office_G	45
561720	Janatorial Services	Bona Fide Conglomerate Inc	3	Other	3
923110	Administration of Education Programs	Department of Education	15	Office_G	15
926110	Administration of General Economic Prog	State Energy Office	7	Office_G	7
561320	Temporary Help Services	Sos Staffing Services, Inc.	1	Office_P	1
561320	Temporary Help Services	Sos Staffing Services, Inc.	15	Office_P	15
621111	Offices of Physicians, ex. Mental Health	Bruce Edward Mullen MD	3	Medical	3
624110	Child and Youth Services	Children's Cabinet	3	Other	3
926110	Administration of General Economic Prog	Museums and History Division	3	Office_G	3
238912	Nonresidential Site Preparation Contrs	Tri-County Construction	7	Constru	7
332710	Machine Shops	Polam Precision Machining Inc	15	Goods_P	15
621210	Offices of Dentists	Marc Nelson DMD Family Dentist	15	Medical	15
926110	Administration of General Economic Prog	Nevada Arts Council	7	Office_G	7
812112	Beauty Salons	Platinum Plus	3	Retail	3
323111	Commercial Gravure Printing	We Ink It Llc	3	Goods_P	3

Douglas County/Carson City Regional Travel Demand Model

SIC_CODE	Industry	Trade_Name	Employment	Model_Category	Total_Emp
621310	Offices of Chiropractors	Carson Tahoe Chiropractic	3	Medical	3
484121	General Freight Trucking, Long-Dist TL	TGM	3	Other	3
453998	Store Retailers Not Specified Elsewhere	Awardzone	3	Retail	3
812990	All Other Personal Services	Annie's Bail Bonds/Action Bail	7	Other	7
541110	Offices of Lawyers	Jennifer S Anderson Ltd	3	Office_P	3
541110	Offices of Lawyers	William F Heckman Atty at Law	3	Office_P	3
531210	Offices of Real Estate Agents & Brokers	John Uhart Commercial Real Est	3	Office_P	3
621330	Offices of Mental Health Practitioners	Constance Sheltren Ph D	3	Medical	3
621210	Offices of Dentists	Coombs & Beglin Orthodon	7	Medical	7
621210	Offices of Dentists	Robert W Bauter & Wm J Holmes	15	Medical	15
621320	Offices of Optometrists	Eastern Sierra Eyecare Inc	7	Medical	7
523120	Securities Brokerage	Jones, Edward D & Company	3	Office_P	3
561320	Temporary Help Services	Value Apothecaries Inc	3	Office_P	3
621111	Offices of Physicians, ex. Mental Health	Gail P Krivan MD Ltd	3	Medical	3
621340	Offices of Specialty Therapists	Optimum Physical Therapy	7	Medical	7
621511	Medical Laboratories	Laboratory Corp. of America	3	Medical	3
621511	Medical Laboratories	Quest Diagnostics	3	Medical	3
621111	Offices of Physicians, ex. Mental Health	B Bottenberg DO PC	7	Medical	7
621111	Offices of Physicians, ex. Mental Health	Pinnacle Pain Medicine	7	Medical	7
531110	Lessors of Residential Buildings	Nevada Rural Housing Authority	25	Office_P	25
561720	Janatorial Services	CJS Cleaning Services	1	Other	1
713990	All Other Amusement and Recreation Ind	Carson Swim Sharks Inc	15	Other	15
541110	Offices of Lawyers	Mark A Winter Attorney	3	Office_P	3
524210	Insurance Agencies and Brokerages	State Farm Insurance	3	Office_P	3
524114	Direct Health/Medical Insurance Carriers	Public Employees Benefits Program	35	Office_P	35
924110	Air, Water and Waste Program Admin	Division of Water Resources	75	Office_G	75
924110	Air, Water and Waste Program Admin	Environmental Protection	250	Office_G	250
924120	Administration of Conservation Programs	Natural Heritage	7	Office_G	7
924120	Administration of Conservation Programs	Conservation/Natural Resources	7	Office_G	7
924120	Administration of Conservation Programs	Parks Division	15	Office_G	15
924120	Administration of Conservation Programs	State Lands	15	Office_G	15
926150	Licensing/Regulating Commercial Sectors	Financial Institutions Division	3	Office_G	3
524292	Third Party Admin of Insurance Funds	Healthscope Benefits	3	Office_P	3
722310	Food Service Contractors	Bistro at the Bryan	3	Food_Dr	3
445120	Convenience Stores	Eagle Valley Market	3	Retail	3
721110	Hotels (except Casino Hotels) and Motels	City Center Motel	7	Hotel_NG	7

Douglas County/Carson City Regional Travel Demand Model

SIC_CODE	Industry	Trade_Name	Employment	Model_Category	Total_Emp
713990	All Other Amusement and Recreation Ind	Childrens Museum of Northern N	7	Other	7
621111	Offices of Physicians, ex. Mental Health	Oasis Anaesthesia Inc	1	Medical	1
621111	Offices of Physicians, ex. Mental Health	Bruce H Baldecchi Md A Pc	1	Medical	1
621111	Offices of Physicians, ex. Mental Health	Stephen D Panter Crna Ltd	3	Medical	3
518210	Data Processing and Related Services	Physician Select Mgmt Llc	15	Office_P	15
561110	Office Administrative Services	Groupone Health Source Inc	3	Office_P	3
424950	Paint & Supplies Merchant Wholesalers	Western Coatings Inc	3	Ware_H	3
562111	Solid Waste Collection	Clean Environment Llc	7	Other	7
511120	Periodical Publishers	Vista Publishing Inc	3	Office_P	3
451130	Sewing, Needlework & Piece Goods Stores	Mill End Fabrics Inc of Carson	3	Retail	3
111419	Other Food Crops Grown Under Cover	Greenhouse Project, The	3	Other	3
522130	Credit Unions	Greater Nevada Credit Union	3	Office_P	3
425120	Wholesale Trade Agents and Brokers	Major Development Corp	1	Other	1
541110	Offices of Lawyers	Volunteer Attorneys for Rural	7	Office_P	7
451110	Sporting Goods Stores	Bikesmith, The	3	Retail	3
721110	Hotels (except Casino Hotels) and Motels	Hardman House	15	Hotel_NG	15
531320	Offices of Real Estate Appraisers	Brad H Lencioni Re Appraisal	3	Office_P	3
531320	Offices of Real Estate Appraisers	Nancy W Milligan Appraisal Svc LLC	3	Office_P	3
541219	Other Accounting Services	Wellington Bookkeeping Service	3	Office_P	3
621210	Offices of Dentists	Mountain Dental	7	Medical	7
522110	Commercial Banking	US Bank National Assoc	7	Office_P	7
339113	Surgical Appliance and Supplies Mfg	Orthopro of Carson City Inc	7	Goods_P	7
621111	Offices of Physicians, ex. Mental Health	Arika Gupta Md Inc	3	Medical	3
621391	Offices of Podiatrists	Sean L Lehmann LLC	3	Medical	3
624110	Child and Youth Services	Elaine F Torres	1	Other	1
237210	Land Subdivision	Allegretti Company	3	Constru	3
621111	Offices of Physicians, ex. Mental Health	Timothy J Doyle MD Ltd	3	Medical	3
561431	Private Mail Centers	Carson City Box Store	3	Office_P	3
814110	Private Households	Mary-Jean Jones	3	Other	3
624410	Child Day Care Services	Kinderland Nursery School	7	Other	7
531110	Lessors of Residential Buildings	Sunset Carson City Apartments	3	Office_P	3
447110	Gasoline Stations w/ Convenience Stores	Arco AM/PM	3	Retail	3
811111	General Automotive Repair	Capitol Automotive	7	Retail	7
561720	Janatorial Services	Little John's Janitorial	3	Other	3
621210	Offices of Dentists	Randall I Wright DDS A Pc	3	Medical	3
446110	Pharmacies and Drug Stores	Mikes Pharmacy	15	Retail	15

Douglas County/Carson City Regional Travel Demand Model

SIC_CODE	Industry	Trade_Name	Employment	Model_Category	Total_Emp
621111	Offices of Physicians, ex. Mental Health	Tumbleweed Medical Grp	7	Medical	7
621111	Offices of Physicians, ex. Mental Health	Timothy J King MD Ltd	3	Medical	3
621111	Offices of Physicians, ex. Mental Health	Carson City Spine	3	Medical	3
621111	Offices of Physicians, ex. Mental Health	William Thomas MD Ltd	3	Medical	3
621112	Offices of Mental Health Physicians	C. Brian Sonderegger MD	7	Medical	7
621111	Offices of Physicians, ex. Mental Health	John P Lagios Neurology	3	Medical	3
621210	Offices of Dentists	Clinton L Euse DDS	3	Medical	3
621310	Offices of Chiropractors	Scott D Kipling DC	3	Medical	3
561730	Landscaping Services	Antonucci Lawn And Garden Inc	7	Other	7
722515	Snack and Nonalcoholic Beverage Bars	Azteca Bakery & Playa Azul Res	7	Food_Dr	7
445110	Supermarkets and Other Grocery Stores	Smith's	95	Retail	95
522110	Commercial Banking	US Bank National Assoc	3	Office_P	3
713290	Other Gambling Industries	Golden Gaming LLC	25	Other	25
722513	Limited-Service Restaurants	Jack in the Box	25	Food_Dr	25
813312	Environment & Conservation Organizations	Carson Water Subconservancy Di	7	Office_P	7
423450	Medical Equipment Merchant Wholesalers	Ampian HR Outsourcing Llc	7	Ware_H	7
541110	Offices of Lawyers	Law Office of Mark A Marsh Esq	3	Office_P	3
541110	Offices of Lawyers	Holland & Hart LLP	3	Office_P	3
541110	Offices of Lawyers	Houghton Jones APC	7	Office_P	7
541211	Offices of Certified Public Accountants	Bertrand & Associates, LLC	3	Office_P	3
541211	Offices of Certified Public Accountants	Bertrand & Associates LLC	7	Office_P	7
561510	Travel Agencies	Travel Advantage Network	3	Office_P	3
446191	Food (Health) Supplement Stores	Dubois Health Center	7	Retail	7
722511	Full-Service Restaurants	Cracker Box Restaurant, The	15	Food_Dr	15
445310	Beer, Wine, and Liquor Stores	Ben's Discount Liquor	7	Retail	7
451110	Sporting Goods Stores	Tahoe Dive Center Llc	3	Retail	3
524210	Insurance Agencies and Brokerages	Interstate Insurance Svcs Inc	3	Office_P	3
722513	Limited-Service Restaurants	Viet Pho of Carson	3	Food_Dr	3
722410	Drinking Places (Alcoholic Beverages)	Remedys	3	Food_Dr	3
423940	Jewelry Merchant Wholesalers	Goldmart.Com	7	Ware_H	7
424330	Women's Clothing Merchant Wholesalers	American Clothing Recyclers	3	Ware_H	3
522110	Commercial Banking	Bank of America	15	Office_P	15
541110	Offices of Lawyers	Scarpello & Huss, Ltd	7	Office_P	7
811118	Other Automotive Mechanical Repair	Just Brakes 750	3	Retail	3
524210	Insurance Agencies and Brokerages	Carlos Torres Insurance Agency	3	Office_P	3
561510	Travel Agencies	World Travel Holdings Inc	7	Office_P	7

Douglas County/Carson City Regional Travel Demand Model

SIC_CODE	Industry	Trade_Name	Employment	Model_Category	Total_Emp
561421	Telephone Answering Services	Jenkins Communications & Comst	15	Office_P	15
722511	Full-Service Restaurants	Titos Restaurant Ltd	15	Food_Dr	15
447110	Gasoline Stations w/ Convenience Stores	Foodmart #1	3	Retail	3
922130	Legal Counsel and Prosecution	Attorney for Injured Workers	15	Office_G	15
923130	Other Human Resource Program Admin	Health Care Financing & Policy	35	Office_G	35
926150	Licensing/Regulating Commercial Sectors	Nevada State Board of Optometr	3	Office_G	3
524298	All Other Insurance Related Activities	HRS Erase Inc	3	Office_P	3
541511	Custom Computer Programming Services	Proficient Business Systems In	3	Office_P	3
561410	Document Preparation Services	West Valley Construction Compa	7	Office_P	7
561990	All Other Support Services	GKL Resident Agents/Filings In	3	Other	3
561990	All Other Support Services	GKL Services Group	3	Other	3
561990	All Other Support Services	GKL Corporate Services	7	Other	7
812191	Diet and Weight Reducing Centers	Weight Watchers N America Inv	15	Retail	15
524210	Insurance Agencies and Brokerages	Dennis C Brinson	3	Office_P	3
922110	Courts	Hearings And Appeals Division	15	Office_G	15
923130	Other Human Resource Program Admin	Health Care Financing & Policy	35	Office_G	35
522110	Commercial Banking	Mutual Of Omaha Bank	3	Office_P	3
524113	Direct Life Insurance Carriers	ING Life Insurance & Annuity	3	Office_P	3
814110	Private Households	Helene Dillon	3	Other	3
926130	Utility Regulation and Administration	Public Utilities Commission	65	Office_G	65
923130	Other Human Resource Program Admin	Health Care Financing & Policy	150	Office_G	150
522291	Consumer Lending	USA Cash Services	3	Office_P	3
621111	Offices of Physicians, ex. Mental Health	Merritt W Dunlap MD PC	3	Medical	3
621111	Offices of Physicians, ex. Mental Health	Carson Medical Group	85	Medical	85
621111	Offices of Physicians, ex. Mental Health	Center for Advanced Eye Care	25	Medical	25
621111	Offices of Physicians, ex. Mental Health	Carson Tahoe Endocrinology	3	Medical	3
621210	Offices of Dentists	Modern Endodontics	7	Medical	7
441120	Used Car Dealers	Park Auto Sales	3	Retail	3
722511	Full-Service Restaurants	Adeles Llc	35	Food_Dr	35
541611	Administrative Management Consulting Svc	Hard Rock Nevada Inc	3	Office_P	3
488410	Motor Vehicle Towing	Samaritania Inc	3	Other	3
812990	All Other Personal Services	Massage Therapeutics Inc	3	Other	3
541213	Tax Preparation Services	Sierra Financial	1	Office_P	1
621310	Offices of Chiropractors	Active Chiropractic Health & W	7	Medical	7
511120	Periodical Publishers	Well Being Journal Inc	3	Office_P	3
624410	Child Day Care Services	Robins Nest Daycare	3	Other	3

Douglas County/Carson City Regional Travel Demand Model

SIC_CODE	Industry	Trade_Name	Employment	Model_Category	Total_Emp
561720	Janatorial Services	American Housekeeping	15	Other	15
621310	Offices of Chiropractors	Sierra Nevada Radiology Consul	3	Medical	3
237990	Other Heavy Construction	J.T Thorpe & Son Inc	1	Constru	1
488510	Freight Transportation Arrangement	Ferrari Expressinc	3	Office_P	3
524210	Insurance Agencies and Brokerages	Country Insurance & Financial	3	Office_P	3
561611	Investigation Services	G4s Compliance & Investigation	3	Office_P	3
561720	Janatorial Services	Site Crew Inc	15	Other	15
813410	Civic and Social Organizations	Retired Public Employees of Nv	3	Office_P	3
621210	Offices of Dentists	Carson Dental Designs	1	Medical	1
621210	Offices of Dentists	Ronald West DMD Pc	7	Medical	7
445291	Baked Goods Stores	La Bakery	7	Retail	7
621511	Medical Laboratories	Labcorp	3	Medical	3
624120	Services for the Elderly and Disabled	Going Places	55	Other	55
621210	Offices of Dentists	John J Amorati DDS Inc	7	Medical	7
541330	Engineering Services	David J Gordon Fan Services LI	1	Office_P	1
621111	Offices of Physicians, ex. Mental Health	Carson Tahoe Urgent Care	15	Medical	15
621493	Freestanding Emergency Medical Centers	Western NV Surgical Ctr Inc	7	Medical	7
621111	Offices of Physicians, ex. Mental Health	Michael J Fischer MD Ltd	7	Medical	7
722410	Drinking Places (Alcoholic Beverages)	Tap Shack, The	3	Food_Dr	3
624410	Child Day Care Services	Puff N Stuff Child Care Center	7	Other	7
621111	Offices of Physicians, ex. Mental Health	Daniel L Hasfurther MD Inc A P	3	Medical	3
541219	Other Accounting Services	Ltrh Medical Billing Service	15	Office_P	15
551114	Managing Offices	Carson Tahoe Health System	25	Office_P	25
561720	Janatorial Services	Federal Cleaning Contractors	7	Other	7
621111	Offices of Physicians, ex. Mental Health	Carson Tahoe Physician Clinics	3	Medical	3
622310	Other Hospitals	Carson Tahoe Continuing Care H	75	Medical	75
621340	Offices of Specialty Therapists	Sports Therapy & Rehab	7	Medical	7
621111	Offices of Physicians, ex. Mental Health	Sierra Nevada Nephrology Consultant	3	Medical	3
621210	Offices of Dentists	William G Van Patten Jr DDS LI	15	Medical	15
621320	Offices of Optometrists	Katrina Van Patten OD Ltd	3	Medical	3
722515	Snack and Nonalcoholic Beverage Bars	Starbucks Coffee	15	Food_Dr	15
541213	Tax Preparation Services	H & R Block	1	Office_P	1
561439	Other Business Service Centers	Fedex Office Inc - 0777	7	Office_P	7
812112	Beauty Salons	Team Clips	15	Retail	15
812320	Drycleaning and Laundry Services	Golden Hanger Cleaners	3	Retail	3
446110	Pharmacies and Drug Stores	Walgreens	15	Retail	15

Douglas County/Carson City Regional Travel Demand Model

SIC_CODE	Industry	Trade_Name	Employment	Model_Category	Total_Emp
446110	Pharmacies and Drug Stores	Walgreens	15	Retail	15
532120	Truck, Trailer and RV Rental and Leasing	U-Haul	7	Other	7
811111	General Automotive Repair	G & D Auto	3	Retail	3
453910	Pet and Pet Supplies Stores	Jans Tropics + Elegant Pooche	3	Retail	3
561320	Temporary Help Services	Moonlighting Personnel Mgmt Sv	7	Office_P	7
336310	Motor Vehicle Gasoline Engine and Engine Part	United Engine & Machine Co	15	Goods_P	15
811118	Other Automotive Mechanical Repair	Brake & Alignment Plus	3	Retail	3
453998	Store Retailers Not Specified Elsewhere	Ponderosa Stamp & Engraving	3	Retail	3
522110	Commercial Banking	Wells Fargo Bank N A	15	Office_P	15
445110	Supermarkets and Other Grocery Stores	Los Caporales Supermarkets	15	Retail	15
522291	Consumer Lending	Paycheck Advance	3	Office_P	3
524210	Insurance Agencies and Brokerages	Robert B Bean Agency Inc	3	Office_P	3
532230	Video Tape and Disc Rental	Game Cozy & Movies	3	Other	3
711320	Promoters without Facilities	Nevada Day Inc	1	Other	1
447110	Gasoline Stations w/ Convenience Stores	Jm Gasoline	3	Retail	3
541330	Engineering Services	Harris & Associates	3	Office_P	3
813990	Other Similar Organizations	Sierra View Condominium Assoc	1	Office_P	1
813940	Political Organizations	Western Representation Pac	3	Office_P	3
624410	Child Day Care Services	ABC Learning Center Inc	7	Other	7
561720	Janatorial Services	High Sierra Cleaning LLC	3	Other	3
441310	Automotive Parts and Accessories Stores	Autozone	15	Retail	15
541690	Other Technical Consulting Services	Intertech Services Corporation	3	Office_P	3
621210	Offices of Dentists	Vincent P Dascoli Dds Ltd	7	Medical	7
624190	Other Individual and Family Services	Carson City Alano Club	3	Other	3
522298	All Other Nondeposit Credit Intermediatn	Bestpawn	7	Office_P	7
561730	Landscaping Services	Uinted Construction Services	7	Other	7
561730	Landscaping Services	Tom Ediss Landscape Inc	15	Other	15
722511	Full-Service Restaurants	China East	7	Food_Dr	7
811192	Car Washes	Prestige Auto Wash LLC	25	Retail	25
447110	Gasoline Stations w/ Convenience Stores	Jacksons Food Stores	3	Retail	3
311811	Retail Bakeries	Donuts To Go	3	Goods_P	3
811191	Automotive Oil Change/Lubrication Shops	Jiffy Lube	7	Retail	7
812112	Beauty Salons	Theresa Guimont Inc	1	Retail	1
531311	Residential Property Managers	Carson Catalina Apartments	7	Office_P	7
236115	New Single-Family Housing Construction	North Star Construction	3	Constru	3
811111	General Automotive Repair	Christensen Automotive of Carson	15	Retail	15

Douglas County/Carson City Regional Travel Demand Model

SIC_CODE	Industry	Trade_Name	Employment	Model_Category	Total_Emp
722513	Limited-Service Restaurants	El Pollo Loco	25	Food_Dr	25
531110	Lessors of Residential Buildings	Menlo Manor #1	3	Office_P	3
531120	Lessors of Nonresidential Buildings	Menlo LLC	3	Office_P	3
441310	Automotive Parts and Accessories Stores	Napa Auto/Truck Parts	25	Retail	25
441120	Used Car Dealers	Small Car Motors Inc	7	Retail	7
522220	Sales Financing	SCM Credit Corporation	3	Office_P	3
425120	Wholesale Trade Agents and Brokers	Theta Oilfield Services Inc	3	Other	3
443142	Electronics Stores	AT T Mobility Services LLC	15	Retail	15
541199	All Other Legal Services	Gettechnical Inc	3	Office_P	3
561431	Private Mail Centers	UPS Store, The	3	Office_P	3
722513	Limited-Service Restaurants	US Submarine Base	3	Food_Dr	3
722513	Limited-Service Restaurants	Papa Murphy's Take And Bake Pizza	15	Food_Dr	15
621310	Offices of Chiropractors	Carson Chiropractic Ctn Ltd	3	Medical	3
721110	Hotels (except Casino Hotels) and Motels	Rand Motel	3	Hotel_NG	3
926130	Utility Regulation and Administration	Nevada Board for the Regulatio	3	Office_G	3
511120	Periodical Publishers	Range Magazine	3	Office_P	3
531320	Offices of Real Estate Appraisers	Sam Ward Real Estate Appraiser	3	Office_P	3
541330	Engineering Services	Stephenson Engineering Ltd	1	Office_P	1
452990	All Other General Merchandise Stores	Tractor Supply Company	15	Retail	15
722511	Full-Service Restaurants	Taqueria La Salsa	1	Food_Dr	1
453110	Florists	Carson City Florist	7	Retail	7
541330	Engineering Services	Phoenix Field Services	7	Office_P	7
531210	Offices of Real Estate Agents & Brokers	Carol Marie Vandenberg-Toohey	3	Office_P	3
812112	Beauty Salons	Latinas Beauty Salon	3	Retail	3
448210	Shoe Stores	Red Wing Shoe Store	3	Retail	3
541213	Tax Preparation Services	Jackson Hewitt	3	Office_P	3
722511	Full-Service Restaurants	Panda Kitchen LLC	3	Food_Dr	3
541940	Veterinary Services	Sierra Veterinary Hospital	25	Office_P	25
531210	Offices of Real Estate Agents & Brokers	Century 21 Jim Wilson Realty	1	Office_P	1
522298	All Other Nondeposit Credit Intermediatn	Titlemax of Carson City	3	Office_P	3
522291	Consumer Lending	Moneytree Inc	7	Office_P	7
722513	Limited-Service Restaurants	Carson City Subway #28790	7	Food_Dr	7
532210	Consumer Electronics & Appliances Rental	Rent-A-Center	3	Other	3
443142	Electronics Stores	Geeks of Nevada Inc	3	Retail	3
561320	Temporary Help Services	Westaff	1	Office_P	1
445310	Beer, Wine, and Liquor Stores	Capital City Liquor & Food Mar	3	Retail	3

Douglas County/Carson City Regional Travel Demand Model

SIC_CODE	Industry	Trade_Name	Employment	Model_Category	Total_Emp
713290	Other Gambling Industries	Gold Dust West Race & Sports Book	3	Other	3
721120	Casino Hotels	Gold Dust West Carson City	250	Hotel_G	250
623312	Homes for the Elderly	Eagle Valley Care Center	15	Other	15
443141	Household Appliance Stores	Carson Vacuum & Cleaning Produ	3	Retail	3
523120	Securities Brokerage	Jones, Edward D & Company	3	Office_P	3
451120	Hobby, Toy, and Game Stores	Bead Store, The	3	Retail	3
722515	Snack and Nonalcoholic Beverage Bars	Dunkin Donuts	3	Food_Dr	3
423830	Industrial Machinery Merchant Whsle	Industrial Plastic Valves Co	3	Ware_H	3
922150	Parole Offices and Probation Offices	Parole and Probation	15	Office_G	15
541370	Other Surveying and Mapping Services	Tri-State Surveying	3	Office_P	3
621310	Offices of Chiropractors	Lisa Bray-Getas Ltd	3	Medical	3
624210	Community Food Services	Friends in Service Helping	25	Other	25
722410	Drinking Places (Alcoholic Beverages)	Y-Not Saloon/AJs Coffee Break	3	Food_Dr	3
524210	Insurance Agencies and Brokerages	Nevada Insurance Agency Co.	7	Office_P	7
713290	Other Gambling Industries	Dotty's	7	Other	7
444130	Hardware Stores	True Value Hardware	15	Retail	15
447110	Gasoline Stations w/ Convenience Stores	Carson City Shell	3	Retail	3
236118	Residential Remodelers	MT Construction	1	Constru	1
238212	Nonresidential Electrical Contractors	Sharpline Multimedia LI	1	Constru	1
236115	New Single-Family Housing Construction	D G Hand Construction Co	15	Constru	15
236118	Residential Remodelers	All Sierra Environmental	7	Constru	7
541213	Tax Preparation Services	Executive Tax Services Inc	3	Office_P	3
812210	Funeral Homes and Funeral Services	Autumn Funeral & Cremations	7	Other	7
541613	Marketing Consulting Services	Realty Profit Systems	3	Office_P	3
624190	Other Individual and Family Services	United Latino Community	3	Other	3
813219	Other Grantmaking and Giving Services	Partnership Carson City	7	Other	7
623312	Homes for the Elderly	Carson Plaza	35	Other	35
561730	Landscaping Services	Pyramid Lawn Service Inc	3	Other	3
923110	Administration of Education Programs	Public Charter School Authority	7	Office_G	7
624120	Services for the Elderly and Disabled	Carson City Senior Citizen Ctr	15	Other	15
531110	Lessors of Residential Buildings	Bella Lago LLC	3	Office_P	3
624110	Child and Youth Services	Delma Salazar	3	Other	3
441310	Automotive Parts and Accessories Stores	O'Reilly Auto Parts	15	Retail	15
811111	General Automotive Repair	Carson Servicenter	3	Retail	3
447110	Gasoline Stations w/ Convenience Stores	Golden Gate Petroleum of Nevada	7	Retail	7
721110	Hotels (except Casino Hotels) and Motels	Royal Inn	3	Hotel_NG	3

Douglas County/Carson City Regional Travel Demand Model

SIC_CODE	Industry	Trade_Name	Employment	Model_Category	Total_Emp
541990	All Other Professional & Technical Svc	Search Group Inc	3	Office_P	3
623312	Homes for the Elderly	The Lodge	65	Other	65
447110	Gasoline Stations w/ Convenience Stores	Arco AM/PM #82340	15	Retail	15
441320	Tire Dealers	Tires Plus	15	Retail	15
238222	Nonresidential Plumbing/HVAC Contractors	Moritz Western Heating & Air C	3	Constru	3
541511	Custom Computer Programming Services	Eureka Design Group	3	Office_P	3
532291	Home Health Equipment Rental	Sierra Oxygen Service	7	Other	7
621111	Offices of Physicians, ex. Mental Health	Mountain Medical	3	Medical	3
621111	Offices of Physicians, ex. Mental Health	Mountain Medical Associate	15	Medical	15
424950	Paint & Supplies Merchant Wholesalers	T & H Auto Paints Inc.	7	Ware_H	7
441310	Automotive Parts and Accessories Stores	Unique Sounds & Auto Accessori	3	Retail	3
445120	Convenience Stores	Video Centro Mini Mart	15	Retail	15
811111	General Automotive Repair	Sunrise Automotive Inc	3	Retail	3
551114	Managing Offices	Sierra Center for Foot Surgery	3	Office_P	3
621391	Offices of Podiatrists	Sierra Podiatry Center LLP	15	Medical	15
444220	Nursery, Garden & Farm Supply Stores	Bensons Feed & Tack	7	Retail	7
531210	Offices of Real Estate Agents & Brokers	Nevada Premier Properties LLC	15	Office_P	15
813990	Other Similar Organizations	Park Terrace East Condominium	3	Office_P	3
238331	Residential Flooring Contractors	M and L Hardwood Flooring LLC	3	Constru	3
238161	Residential Roofing Contractors	East Fork Roofing	7	Constru	7
541511	Custom Computer Programming Services	Sawcor Inc	1	Office_P	1
561320	Temporary Help Services	Asereth Medical Services Inc	1	Office_P	1
561431	Private Mail Centers	Carson Mail Depot	3	Office_P	3
561990	All Other Support Services	Nevada Business Services	3	Other	3
441310	Automotive Parts and Accessories Stores	TSA Custom Car & Truck	3	Retail	3
811111	General Automotive Repair	Marios Auto Repair	3	Retail	3
623110	Nursing Care Facilities	Carson Nursing & Rehabilitation Ctr	75	Other	75
238911	Residential Site Preparation Contractors	Millard Realty & Construction	15	Constru	15
441120	Used Car Dealers	Experience Cars	7	Retail	7
814110	Private Households	Ron Krehbiel	1	Other	1
454111	Electronic Shopping	Ovitaminpro	3	Retail	3
722515	Snack and Nonalcoholic Beverage Bars	Carson Coffee	3	Food_Dr	3
445110	Supermarkets and Other Grocery Stores	Dollar General	7	Retail	7
531130	Miniwarehouses and Self-Storage Unit	Stor & Lock	3	Office_P	3
238911	Residential Site Preparation Contractors	JLW Holdings Llc	3	Constru	3
811113	Automotive Transmission Repair	AAMCO Transmissions	3	Retail	3

Douglas County/Carson City Regional Travel Demand Model

SIC_CODE	Industry	Trade_Name	Employment	Model_Category	Total_Emp
443141	Household Appliance Stores	Valley Appliance	7	Retail	7
454111	Electronic Shopping	Velocity Publishing Inc	3	Retail	3
454111	Electronic Shopping	Bellissimo Inc	3	Retail	3
523930	Investment Advice	Ameriprise Financial Services, Inc	3	Office_P	3
524210	Insurance Agencies and Brokerages	Jewels Benefits Incorporated	3	Office_P	3
541219	Other Accounting Services	Swartz Bookkeeping & Tax	3	Office_P	3
541511	Custom Computer Programming Services	Software & Engineering Associates	3	Office_P	3
541611	Administrative Management Consulting Svc	Sox Consulting Firm LLC	1	Office_P	1
551114	Managing Offices	Environmental Potentials	3	Office_P	3
551114	Managing Offices	Andrew M Martin Co NV Inc	3	Office_P	3
561320	Temporary Help Services	Labor Finders	35	Office_P	35
561612	Security Guards and Patrol Services	International Defense Corp	1	Other	1
561990	All Other Support Services	Val-U-Corp Services Inc	1	Other	1
624310	Vocational Rehabilitation Services	Ormsby Arc-Ormsby Industries	15	Other	15
531311	Residential Property Managers	Foothill Gardens	3	Office_P	3
531110	Lessors of Residential Buildings	Warren Properties Inc	3	Office_P	3
722513	Limited-Service Restaurants	Taco Bell	35	Food_Dr	35
722511	Full-Service Restaurants	China Chef	3	Food_Dr	3
443142	Electronics Stores	Radioshack Corp	3	Retail	3
445110	Supermarkets and Other Grocery Stores	Carson City Grocery Outlet	25	Retail	25
812310	Coin-Operated Laundries and Drycleaners	Wash Tubs & Tubbys	3	Retail	3
722513	Limited-Service Restaurants	Pizza Factory of Carson City	15	Food_Dr	15
445110	Supermarkets and Other Grocery Stores	Save Mart Supermarkets	55	Retail	55
722513	Limited-Service Restaurants	Domino's Pizza	25	Food_Dr	25
814110	Private Households	Matthew Lucksinger	3	Other	3
811111	General Automotive Repair	G M G Foreign Auto	3	Retail	3
722513	Limited-Service Restaurants	Dairy Queen	15	Food_Dr	15
236115	New Single-Family Housing Construction	Eureka Builders Inc	7	Constru	7
441228	Motorcycle, ATV, and All Other Motor Vehicle	Adventure Motostuff LLC	1	Retail	1
522291	Consumer Lending	Advance America Cash	3	Office_P	3
541213	Tax Preparation Services	Jackson Hewitt	1	Office_P	1
713290	Other Gambling Industries	Dotty's	7	Other	7
448190	Other Clothing Stores	Adam & Eve	7	Retail	7
524210	Insurance Agencies and Brokerages	L A Chamberlain Agency	3	Office_P	3
722511	Full-Service Restaurants	El Aguila Real Inc	7	Food_Dr	7
722511	Full-Service Restaurants	KEI Corporation	15	Food_Dr	15

Douglas County/Carson City Regional Travel Demand Model

SIC_CODE	Industry	Trade_Name	Employment	Model_Category	Total_Emp
446110	Pharmacies and Drug Stores	Medcare Pharmacy	15	Retail	15
446110	Pharmacies and Drug Stores	CVS Rx Services Inc	3	Retail	3
446110	Pharmacies and Drug Stores	Longs Drug Stores California	15	Retail	15
238992	All Other Nonresidential Trade Contrs	RG Construction	7	Constru	7
441120	Used Car Dealers	Capital Auto Sales Inc	3	Retail	3
238321	Residential Painting Contractors	Tru Coverage Painting	3	Constru	3
812112	Beauty Salons	Mj Salon Inc	3	Retail	3
624410	Child Day Care Services	Little Tikes Too	7	Other	7
721110	Hotels (except Casino Hotels) and Motels	Carson Inn	3	Hotel_NG	3
441120	Used Car Dealers	Country Auto Sales	1	Retail	1
236118	Residential Remodelers	Lake Side Construction	3	Constru	3
447110	Gasoline Stations w/ Convenience Stores	Country Store / Smoke Shop	7	Retail	7
541690	Other Technical Consulting Services	Mahoney & Associates Consulting	3	Office_P	3
238142	Nonresidential Masonry Contractors	Mountain Masonry	1	Constru	1
541420	Industrial Design Services	Design Identity Group	3	Office_P	3
923140	Administration of Veterans' Affairs	Veterans Employment and Training Se	3	Office_G	3
624310	Vocational Rehabilitation Services	Carson Join	7	Other	7
923130	Other Human Resource Program Admin	Employment Security Division	15	Office_G	15
923130	Other Human Resource Program Admin	Rehabilitation Division	7	Office_G	7
561320	Temporary Help Services	Manpower Temporary Services	150	Office_P	150
923130	Other Human Resource Program Admin	Employment Security Division	150	Office_G	150
926110	Administration of General Economic Prog	DETR Administrative Services	25	Office_G	25
522291	Consumer Lending	Maverick Finance	3	Office_P	3
531190	Lessors of Other Real Estate Property	Silver State Mobile Home Park	3	Office_P	3
522291	Consumer Lending	Loan Max	3	Office_P	3
238311	Residential Drywall Contractors	SE Drywall	15	Constru	15
519120	Libraries and Archives	General Services	3	Office_G	3
923130	Other Human Resource Program Admin	Employment Security Division	15	Office_G	15
721110	Hotels (except Casino Hotels) and Motels	Phillips Motel	3	Hotel_NG	3
624110	Child and Youth Services	Boys & Girls Club of Western N	55	Other	55
713210	Casinos (except Casino Hotels)	Jackpot Crossing Casino	35	Other	35
561730	Landscaping Services	Steve Pecorilla Hydroseeding	1	Other	1
238991	All Other Residential Trade Constructors	Curbit	1	Constru	1
811219	Other Electronic Equipment Repair	Accuray Incorporated	3	Retail	3
311830	Tortilla Manufacturing	Sierra Tortillas	3	Goods_P	3
331491	Nonferrous, ex. Copper/Aluminum, Shaping	United States Welding Corporat	35	Goods_P	35

Douglas County/Carson City Regional Travel Demand Model

SIC_CODE	Industry	Trade_Name	Employment	Model_Category	Total_Emp
423920	Toy and Hobby Goods Merchant Wholesalers	Lovevo Inc	3	Ware_H	3
424210	Druggists' Goods Merchant Wholesalers	Cynergy LLC	3	Ware_H	3
813319	Other Social Advocacy Organizations	NV Public Health Foundation Inc	15	Office_P	15
446110	Pharmacies and Drug Stores	CVS Rx Services Inc	3	Retail	3
446110	Pharmacies and Drug Stores	Longs Drug Stores California	15	Retail	15
441310	Automotive Parts and Accessories Stores	NC Auto Parts, LLC	7	Retail	7
453310	Used Merchandise Stores	Goodwill Industries of Northern Nv	35	Retail	35
541511	Custom Computer Programming Services	EDU2000 America Inc	3	Office_P	3
519130	Internet Publishing & Broadcasting and Web Se	Concrete Equipment Zone LLC	3	Office_P	3
444210	Outdoor Power Equipment Stores	Carson Small Engines	3	Retail	3
522291	Consumer Lending	Paycheck Advance	3	Office_P	3
621320	Offices of Optometrists	Pritchett Eye Care	7	Medical	7
561730	Landscaping Services	Countryside Lawn Service	3	Other	3
238991	All Other Residential Trade Constructors	Finest Fence LLC	3	Constru	3
238211	Residential Electrical Contractors	All Sierra Electrical Llc	1	Constru	1
621310	Offices of Chiropractors	Advanced Chiropractic #1	3	Medical	3
811118	Other Automotive Mechanical Repair	Action Frame & Automotive	3	Retail	3
541191	Title Abstract and Settlement Offices	First Centennial	3	Office_P	3
524210	Insurance Agencies and Brokerages	Marilyn Lewis State Farm Insur	7	Office_P	7
812112	Beauty Salons	Hairline, The	3	Retail	3
813920	Professional Organizations	Nevada Primary Care Associatio	15	Office_P	15
524210	Insurance Agencies and Brokerages	James R Gray Insurance	3	Office_P	3
541191	Title Abstract and Settlement Offices	Fidelity National Mgmt Servic	15	Office_P	15
541310	Architechtrual Services	J P Copoulos Architect	3	Office_P	3
621210	Offices of Dentists	Carson City Family Dentistry	7	Medical	7
722513	Limited-Service Restaurants	Subway 10368	7	Food_Dr	7
624120	Services for the Elderly and Disabled	Going Places	25	Other	25
522291	Consumer Lending	Your Credit	3	Office_P	3
517110	Wired Telecommunications Carriers	Charter Communications	25	Office_P	25
722410	Drinking Places (Alcoholic Beverages)	Crossroads Lounge	7	Food_Dr	7
445110	Supermarkets and Other Grocery Stores	El Torito	3	Retail	3
812310	Coin-Operated Laundries and Drycleaners	P & L Launderlandlion Cleaners	3	Retail	3
621991	Blood and Organ Banks	United Blood Service	7	Medical	7
812111	Barber Shops	Capital Barber Shop	1	Retail	1
445310	Beer, Wine, and Liquor Stores	Ez Market	3	Retail	3
812320	Drycleaning and Laundry Services	Winnie Center Cleaners	3	Retail	3

Douglas County/Carson City Regional Travel Demand Model

SIC_CODE	Industry	Trade_Name	Employment	Model_Category	Total_Emp
624120	Services for the Elderly and Disabled	Home Instead Senior Care	55	Other	55
524210	Insurance Agencies and Brokerages	Allstate Insurance	3	Office_P	3
812112	Beauty Salons	Paradise and Spear Me	7	Retail	7
444210	Outdoor Power Equipment Stores	Nevada Power Products, Inc.	3	Retail	3
531110	Lessors of Residential Buildings	University Heights Llc	7	Office_P	7
522298	All Other Nondeposit Credit Intermediatn	Clear Creek Storage Facility	3	Office_P	3
238141	Residential Masonry Contractors	Great Basin Masonry Inc	3	Constru	3
236118	Residential Remodelers	OR Home Craftmanship	3	Constru	3
551114	Managing Offices	Mcdonald's	7	Office_P	7
722513	Limited-Service Restaurants	Mcdonald's	35	Food_Dr	35
522291	Consumer Lending	Quik Cash	3	Office_P	3
541213	Tax Preparation Services	Liberty Tax	1	Office_P	1
551114	Managing Offices	Maklaf Operations Inc	7	Office_P	7
541820	Public Relations Agencies	TMT Worldwide Inc	3	Office_P	3
561110	Office Administrative Services	JLK Enterprises	3	Office_P	3
522110	Commercial Banking	Wells Fargo Bank N A	3	Office_P	3
522298	All Other Nondeposit Credit Intermediatn	Superpawn	7	Office_P	7
237110	Water and Sewer System Construction	Canyon Creek Construction	1	Constru	1
425120	Wholesale Trade Agents and Brokers	MFB Corp	3	Other	3
484121	General Freight Trucking, Long-Dist TL	Coast to Coast Freight Movers	3	Other	3
541611	Administrative Management Consulting Svc	Quale Incorporated	1	Office_P	1
541613	Marketing Consulting Services	Trichem Inc	3	Office_P	3
561110	Office Administrative Services	Barretto Pacific Corporation	3	Office_P	3
621310	Offices of Chiropractors	Carson Valley Chiropractic Ltd	3	Medical	3
447110	Gasoline Stations w/ Convenience Stores	7-Eleven #2236-32303a	7	Retail	7
713210	Casinos (except Casino Hotels)	Slotworld Inc	85	Other	85
713290	Other Gambling Industries	Leroy's Horse & Sports Place	3	Other	3
811420	Reupholstery and Furniture Repair	Johnnys Upholstery	3	Retail	3
541611	Administrative Management Consulting Svc	Colleen Crum Management Servic	3	Office_P	3
447110	Gasoline Stations w/ Convenience Stores	Eagle Gas	3	Retail	3
238211	Residential Electrical Contractors	Tesco Controls Inc	3	Constru	3
811122	Automotive Glass Replacement Shops	Sun King Window Tinting	3	Retail	3
311612	Meat Processed from Carcasses	Sausage Factory Inc	15	Goods_P	15
444190	Other Building Material Dealers	Consolidated Electrical Distributor	3	Retail	3
238221	Residential Plumbing/HVAC Contractors	Acme Heating & Air Conditionin	3	Constru	3
811111	General Automotive Repair	Valley Wagon	3	Retail	3

Douglas County/Carson City Regional Travel Demand Model

SIC_CODE	Industry	Trade_Name	Employment	Model_Category	Total_Emp
524292	Third Party Admin of Insurance Funds	Arthur J Gallagher Service Company	3	Office_P	3
236115	New Single-Family Housing Construction	John Anderson Construction, Inc	3	Constru	3
446199	All Other Health & Personal Care Stores	Mobility Sales LLC	1	Retail	1
621310	Offices of Chiropractors	Hamtak Chiropractic Health Ctn	3	Medical	3
451120	Hobby, Toy, and Game Stores	Hobbytown USA	1	Retail	1
811121	Automotive Body and Interior Repair	Preferred Auto Body	7	Retail	7
561612	Security Guards and Patrol Services	Capital City Patrol & Transit	3	Other	3
811121	Automotive Body and Interior Repair	A-Ok Upholstery	3	Retail	3
443142	Electronics Stores	Computer Crew of Carson City	1	Retail	1
624410	Child Day Care Services	Shelly Bellies Childcare	3	Other	3
624410	Child Day Care Services	Educare Dei Montessori	7	Other	7
722513	Limited-Service Restaurants	Jimmy Johns	25	Food_Dr	25
623312	Homes for the Elderly	Whispering Heights	7	Other	7
441320	Tire Dealers	Big O Tire Store #64	15	Retail	15
811121	Automotive Body and Interior Repair	Vintage Class Motorcars, Inc	15	Retail	15
442210	Floor Covering Stores	Atkins House of Carpet Inc	7	Retail	7
722511	Full-Service Restaurants	Pizza Hut	25	Food_Dr	25
812310	Coin-Operated Laundries and Drycleaners	Economy Wash N Dry	3	Retail	3
531190	Lessors of Other Real Estate Property	Safari Mobile Home Park	3	Office_P	3
722511	Full-Service Restaurants	Pho Country	7	Food_Dr	7
423830	Industrial Machinery Merchant Whsle	A-L Sierra Welding Products	7	Ware_H	7
238111	Residential Poured Foundation Contractor	Burson Custom Concrete	7	Constru	7
238221	Residential Plumbing/HVAC Contractors	Precision Plumbing & Heating	7	Constru	7
524126	Direct Property and Casualty Insurers	State Farm Fire & Casualty Company	3	Office_P	3
561320	Temporary Help Services	Employees Co of Nevada Inc	3	Office_P	3
561720	Janatorial Services	Cocos Janitorial Service	3	Other	3
238911	Residential Site Preparation Contractors	MNW Construction, Llc	3	Constru	3
722513	Limited-Service Restaurants	Kentucky Fried Chicken	15	Food_Dr	15
923130	Other Human Resource Program Admin	Rehabilitation Division	85	Office_G	85
238191	Other Residential Exterior Contractors	Great Basin Deck & Shade	15	Constru	15
238292	Other Nonresidential Equipment Contrs	Sundance Service	7	Constru	7
561730	Landscaping Services	Landscape Maintenance Services	7	Other	7
811111	General Automotive Repair	Jigsaw Auto	3	Retail	3
236220	Commercial Building Construction	Gwinn Construction Inc-Nevada	1	Constru	1
236220	Commercial Building Construction	Severn International Inc	3	Constru	3
425120	Wholesale Trade Agents and Brokers	Natural Reflections Inc	3	Other	3

Douglas County/Carson City Regional Travel Demand Model

SIC_CODE	Industry	Trade_Name	Employment	Model_Category	Total_Emp
519130	Internet Publishing & Broadcasting and Web Se	Womens Online Media & Education Net	3	Office_P	3
541511	Custom Computer Programming Services	Arc System	1	Office_P	1
541611	Administrative Management Consulting Svc	ALCC Inc	1	Office_P	1
541611	Administrative Management Consulting Svc	Western Pacific Inc	3	Office_P	3
561990	All Other Support Services	Goldrea USA Inc	3	Other	3
561990	All Other Support Services	Laughlin Associates Inc	25	Other	25
441120	Used Car Dealers	Exclusive Auto Sales	1	Retail	1
561720	Janatorial Services	Exec Ceiling & Window Cleaning	3	Other	3
454111	Electronic Shopping	Ganeshaspice.Com LLC	3	Retail	3
541219	Other Accounting Services	Accounting Solutions LLC	3	Office_P	3
491110	Postal Service	USPS Car-Ormsby Sta	3	Other	3
238991	All Other Residential Trade Constructors	Timberline Pools & Spas Inc	3	Constru	3
452990	All Other General Merchandise Stores	Dollar Tree	25	Retail	25
485999	All Other Ground Passenger Transport	MV Contract Transportation Inc	15	Other	15
624120	Services for the Elderly and Disabled	Nevada Rural Counties RSVP Prg	45	Other	45
624190	Other Individual and Family Services	Ron Wood Family Resource Cente	15	Other	15
334418	Printed Circuit Assemblies	HYTEK Microsystems Inc	35	Goods_P	35
624110	Child and Youth Services	Sharon E Riggs	3	Other	3
924120	Administration of Conservation Programs	Bureau of Land Mgmt	150	Office_G	150
541940	Veterinary Services	D O C S Veterinary Hospital	15	Office_P	15
561622	Locksmiths	Alpine Lock Inc	3	Other	3
325910	Printing Ink Manufacturing	Taiyo America Inc	35	Goods_P	35
532291	Home Health Equipment Rental	Pacific Pulmonary Services	3	Other	3
623210	Residential Mental Retardation Facility	Mentor Management	15	Other	15
236115	New Single-Family Housing Construction	John Anderson Construction Inc	3	Constru	3
236220	Commercial Building Construction	Project One	1	Constru	1
541219	Other Accounting Services	Sky High Sports LLC	7	Office_P	7
531190	Lessors of Other Real Estate Property	Lone Mountain Mobile Home Comm	3	Office_P	3
444130	Hardware Stores	Harbor Freight Tools	15	Retail	15
621210	Offices of Dentists	P Chris Kleintjes DDS Ltd	1	Medical	1
621210	Offices of Dentists	Lone Mountain Family Dentistry	7	Medical	7
561720	Janatorial Services	Sun West Building Services of	7	Other	7
238151	Residential Glass/Glazing Contractors	Nevada Glass Service	7	Constru	7
441320	Tire Dealers	Allied Tire and Automotive Ser	3	Retail	3
444190	Other Building Material Dealers	Carson Masonry & Steel Supply	15	Retail	15
423720	Plumbing Goods Merchant Wholesalers	Afton Medical LLC	3	Ware_H	3

Douglas County/Carson City Regional Travel Demand Model

SIC_CODE	Industry	Trade_Name	Employment	Model_Category	Total_Emp
811121	Automotive Body and Interior Repair	Master Auto Body	3	Retail	3
551114	Managing Offices	Art Wilson Co.	7	Office_P	7
551114	Managing Offices	Capital Sanitation-Ops	3	Office_P	3
562212	Solid Waste Landfill	Capital Sanitation	45	Other	45
541110	Offices of Lawyers	Dyer Lawrence Penrose Flaherty	7	Office_P	7
441210	Recreational Vehicle Dealers	Silver State	7	Retail	7
454390	Other Direct Selling Establishments	Silver State Water & Coffee Serv.	7	Retail	7
238152	Nonresidential Glass/Glazing Contractors	Capital Glass	35	Constru	35
811111	General Automotive Repair	Nevada Auto Repair	3	Retail	3
623312	Homes for the Elderly	Mtn Springs Assisted Living	35	Other	35
621512	Diagnostic Imaging Centers	Great Basin Imaging	15	Medical	15
621512	Diagnostic Imaging Centers	Tahoe Carson Radiology Ltd	15	Medical	15
621610	Home Health Care Services	Quality Health Care Corp.	15	Other	15
531190	Lessors of Other Real Estate Property	Marchand Enterprises Mobile Ho	3	Office_P	3
561730	Landscaping Services	Montoya Landscape Maintenance	3	Other	3
541613	Marketing Consulting Services	Fun Kitty Inc	1	Office_P	1
446199	All Other Health & Personal Care Stores	Sierra Nevada Hearing Aid Cent	3	Retail	3
621111	Offices of Physicians, ex. Mental Health	Roger Rogalski MD CHTD	3	Medical	3
621111	Offices of Physicians, ex. Mental Health	Sierra Nevada Surgical Associa	7	Medical	7
621111	Offices of Physicians, ex. Mental Health	Sierra Nevada ENT Assoc	15	Medical	15
621111	Offices of Physicians, ex. Mental Health	Eagle Medical Center	25	Medical	25
621210	Offices of Dentists	Jack I Newman DDS	7	Medical	7
621320	Offices of Optometrists	See Center, The	3	Medical	3
621340	Offices of Specialty Therapists	High Desert Therapists Inc	7	Medical	7
624190	Other Individual and Family Services	Sierra Counseling & Neurothera	3	Other	3
334220	Broadcast & Wireless Communication Equip	Triangle Labs Inc	15	Goods_P	15
237310	Highway, Street, and Bridge Construction	Brown Brothers Const Inc	3	Constru	3
332710	Machine Shops	Owens Precision Inc	55	Goods_P	55
238161	Residential Roofing Contractors	N R C Roofing & Waterproofing	7	Constru	7
238321	Residential Painting Contractors	Precise Painting	3	Constru	3
339116	Dental Laboratories	Grover Dental Lab	3	Goods_P	3
531190	Lessors of Other Real Estate Property	Villa Sierra Mobile Home Park	3	Office_P	3
611210	Junior Colleges	Western Nevada College	550	School	550
541330	Engineering Services	Rasner Consulting Inc	3	Office_P	3
811191	Automotive Oil Change/Lubrication Shops	Jiffy Lube	7	Retail	7
541219	Other Accounting Services	Water Inc	3	Office_P	3

Douglas County/Carson City Regional Travel Demand Model

SIC_CODE	Industry	Trade_Name	Employment	Model_Category	Total_Emp
238131	Residential Framing Contractors	Jim Weninger Construction	3	Constru	3
722310	Food Service Contractors	Lifted Cafe	1	Food_Dr	1
531110	Lessors of Residential Buildings	Sierra Springs Aparatments	3	Office_P	3
811310	Commercial Machinery Repair/Maintenance	Sonda Foods, Inc	7	Retail	7
488410	Motor Vehicle Towing	Carson City Towing Inc	15	Other	15
522110	Commercial Banking	Bank of the West	7	Office_P	7
336214	Travel Trailer and Camper Manufacturing	Fireventllc	3	Goods_P	3
811121	Automotive Body and Interior Repair	Rene Contreras	1	Retail	1
451211	Book Stores	Wnc Bookstore	3	Retail	3
921130	Public Finance Activities	Public Employees Retiremnt Sys	65	Office_G	65
441210	Recreational Vehicle Dealers	Carson City RV	7	Retail	7
621111	Offices of Physicians, ex. Mental Health	Nevada Heart Institute	3	Medical	3
923130	Other Human Resource Program Admin	Dept of Health and Human Resources	3	Office_G	3
541211	Offices of Certified Public Accountants	Martin Jones & Associates	3	Office_P	3
541511	Custom Computer Programming Services	Apex Computing Inc	15	Office_P	15
561320	Temporary Help Services	Kelly Temporary Services	45	Office_P	45
621610	Home Health Care Services	Gentiva Certified Healthcare	45	Other	45
523120	Securities Brokerage	Jones, Edward D & Company	3	Office_P	3
621320	Offices of Optometrists	Stephen S Palazzolo Od	7	Medical	7
621340	Offices of Specialty Therapists	Nanci Campbell Aud	3	Medical	3
926110	Administration of General Economic Prog	Commission on Economic Development	15	Office_G	15
541110	Offices of Lawyers	Mahe Law Ltd	3	Office_P	3
921110	Executive Offices	Ethics Commission	7	Office_G	7
541511	Custom Computer Programming Services	MIS 2000	3	Office_P	3
541990	All Other Professional & Technical Svc	Nevada State EB 5 Regional Center	3	Office_P	3
621111	Offices of Physicians, ex. Mental Health	Rowes Skin Cancer Institute O	3	Medical	3
621111	Offices of Physicians, ex. Mental Health	Daniel Robertson MD	3	Medical	3
621111	Offices of Physicians, ex. Mental Health	Kent W Gabriel MD PC	7	Medical	7
813910	Business Associations	Western Nevada Development District	3	Office_P	3
813910	Business Associations	Northern NV Development Author	7	Office_P	7
454111	Electronic Shopping	1 Professional Skin Care LLC	1	Retail	1
236220	Commercial Building Construction	Dynamic Diversified Development	7	Constru	7
524210	Insurance Agencies and Brokerages	Abowd & Rose Financial Group L	15	Office_P	15
524292	Third Party Admin of Insurance Funds	Associated Risk Management Inc	25	Office_P	25
541211	Offices of Certified Public Accountants	Steele & Associates LLC	7	Office_P	7
621111	Offices of Physicians, ex. Mental Health	Hak-Sun Bak PLLC	3	Medical	3

Douglas County/Carson City Regional Travel Demand Model

SIC_CODE	Industry	Trade_Name	Employment	Model_Category	Total_Emp
621111	Offices of Physicians, ex. Mental Health	Northern Nevada Anesthesia Associa	7	Medical	7
621340	Offices of Specialty Therapists	Carson Physical Therapy	7	Medical	7
561730	Landscaping Services	Pecorilla Hydroseeding	1	Other	1
425120	Wholesale Trade Agents and Brokers	Kjm Semiconductor Inc	3	Other	3
524210	Insurance Agencies and Brokerages	Jeff Brooks Insurance Agency L	3	Office_P	3
541219	Other Accounting Services	Elite Bookkeeping & Tax Serv	3	Office_P	3
541611	Administrative Management Consulting Svc	American Corporate Enterprises	3	Office_P	3
541618	Other Management Consulting Services	Digital Access Inc	1	Office_P	1
541910	Marketing Research & Public Opinion Poll	Petrini Advisors Team Inc	3	Office_P	3
561110	Office Administrative Services	Total Management Systems Inc	3	Office_P	3
811192	Car Washes	A+ Custom Detail	3	Retail	3
531311	Residential Property Managers	Capital Property Services LLC	3	Office_P	3
541191	Title Abstract and Settlement Offices	Stewart Title	3	Office_P	3
924110	Air, Water and Waste Program Admin	Environmental Protection Agency	3	Office_G	3
519120	Libraries and Archives	General Services	75	Office_G	75
921190	Other General Government Support	Enterprise IT Services	25	Office_G	25
621210	Offices of Dentists	Advanced Dentistry by Design	15	Medical	15
446199	All Other Health & Personal Care Stores	Hanger Prosthetics & Orthotics, Inc	1	Retail	1
531110	Lessors of Residential Buildings	Sierra Madre Apartments	3	Office_P	3
441228	Motorcycle, ATV, and All Other Motor Vehicle	Carson City Harley Davidson	35	Retail	35
484230	Other Specialized Trucking, Long-Dist	Jkl Secure Freight Lines	15	Other	15
811490	Other Household Goods Repair/Maintenance	Carson-Tahoe Marine Inc	3	Retail	3
423830	Industrial Machinery Merchant Whsle	Carson Underground Inc	15	Ware_H	15
326199	All Other Plastics Product Manufacturing	Carson Hi-Tech Inc	7	Goods_P	7
332710	Machine Shops	G & S Grinding Co Inc	1	Goods_P	1
332999	Miscellaneous Fabricated Metal Products	Excab Inc	3	Goods_P	3
484210	Used Household and Office Goods Moving	Carson Valley Movers	7	Other	7
423830	Industrial Machinery Merchant Whsle	Hydraulic/Industrial Srvs Inc	7	Ware_H	7
624120	Services for the Elderly and Disabled	Dungarvin Nevada Llc	35	Other	35
447110	Gasoline Stations w/ Convenience Stores	Quik Stop Markets	7	Retail	7
561320	Temporary Help Services	Spherion Staffing Llc	35	Office_P	35
722511	Full-Service Restaurants	Z Bistro	3	Food_Dr	3
236220	Commercial Building Construction	Metcalf Builders Inc	3	Constru	3
561990	All Other Support Services	Registered Agent Inc	3	Other	3
713940	Fitness and Recreational Sports Centers	Kaia F.I.T	3	Other	3
561320	Temporary Help Services	Cariant Health Partners Inc	1	Office_P	1

Douglas County/Carson City Regional Travel Demand Model

SIC_CODE	Industry	Trade_Name	Employment	Model_Category	Total_Emp
561720	Janatorial Services	Ormsby Post Acure Rehab	15	Other	15
621340	Offices of Specialty Therapists	Therapeutic Resources Inc	3	Medical	3
621340	Offices of Specialty Therapists	Evergreen CC Health & Rehab Ct	15	Medical	15
623110	Nursing Care Facilities	Evergreen CC Health & Rehab Ct	150	Other	150
722511	Full-Service Restaurants	Villa Basque Deli	7	Food_Dr	7
621492	Kidney Dialysis Centers	Dialysis Clinic Inc	35	Medical	35
811219	Other Electronic Equipment Repair	Datagate Systems LLC	3	Retail	3
335313	Switchgear and Switchboard Apparatus	Ametherm Inc	55	Goods_P	55
721110	Hotels (except Casino Hotels) and Motels	Days Inn Carson City	7	Hotel_NG	7
531120	Lessors of Nonresidential Buildings	Caramella Ballardini Investmen	1	Office_P	1
425120	Wholesale Trade Agents and Brokers	Texas Pneumatic Tools Inc	3	Other	3
611519	Other Technical and Trade Schools	Bodhi Tree Center For Healing	7	School	7
811111	General Automotive Repair	Carson City Automotive	7	Retail	7
238912	Nonresidential Site Preparation Contrs	Rapid Construction Co	15	Constru	15
423610	Wiring & Equipment Merchant Wholesalers	Rexel Pacific	3	Ware_H	3
484220	Other Specialized Trucking, Local	Gavco Distribution Inc	15	Other	15
424210	Druggists' Goods Merchant Wholesalers	Pure Ground Ingredients Inc	15	Ware_H	15
722410	Drinking Places (Alcoholic Beverages)	Eds Dog House	3	Food_Dr	3
236118	Residential Remodelers	Robert Rumbaugh Construction I	1	Constru	1
624110	Child and Youth Services	Donna Ganoe	1	Other	1
485310	Taxi Service	Capitol Cab Co	7	Other	7
423720	Plumbing Goods Merchant Wholesalers	Carson Valley Supply Inc	3	Ware_H	3
541110	Offices of Lawyers	Law Office of Wayne M Pressel	3	Office_P	3
541611	Administrative Management Consulting Svc	NFA Consulting Inc	3	Office_P	3
541690	Other Technical Consulting Services	Aqua Hydrogeologic Cons LLC	1	Office_P	1
423990	All Other Durable Goods Merchant Whsle	Washoe Valley Farrier Supply	3	Ware_H	3
454111	Electronic Shopping	Sweatsedo	3	Retail	3
722511	Full-Service Restaurants	La Posada Real	15	Food_Dr	15
323111	Commercial Gravure Printing	Comstock Printers	1	Goods_P	1
424490	Other Grocery Product Merchant Whsle	L & M Distributing	3	Ware_H	3
561730	Landscaping Services	Green Lizard Landscape LLC	3	Other	3
423450	Medical Equipment Merchant Wholesalers	Alta Diagnostics Inc	3	Ware_H	3
425120	Wholesale Trade Agents and Brokers	United AG Services	7	Other	7
484220	Other Specialized Trucking, Local	United AG Trucking LLC	3	Other	3
561730	Landscaping Services	Battle Born Tree Service LLC	1	Other	1
423710	Hardware Merchant Wholesalers	Fastenal Co	3	Ware_H	3

Douglas County/Carson City Regional Travel Demand Model

SIC_CODE	Industry	Trade_Name	Employment	Model_Category	Total_Emp
722511	Full-Service Restaurants	Spoke Bar & Grill, The	7	Food_Dr	7
441320	Tire Dealers	Tires for You	3	Retail	3
454113	Mail-Order Houses	Image Perspectives	3	Retail	3
493110	General Warehousing and Storage	Namics Technologies Inc	3	Ware_H	3
722513	Limited-Service Restaurants	Brugos Pizza Co	7	Food_Dr	7
541330	Engineering Services	Brown And Caldwell Constructors	3	Office_P	3
541330	Engineering Services	Brown & Caldwell	15	Office_P	15
441320	Tire Dealers	Les Schwab Tire Center	15	Retail	15
423710	Hardware Merchant Wholesalers	Top Notch Distributors of Nv	35	Ware_H	35
531110	Lessors of Residential Buildings	Modoco LLC	3	Office_P	3
424490	Other Grocery Product Merchant Whsle	Bimbo Bakeries	15	Ware_H	15
722515	Snack and Nonalcoholic Beverage Bars	Starbucks Coffee	15	Food_Dr	15
238221	Residential Plumbing/HVAC Contractors	Cavallero Heating & Air Cond	85	Constru	85
236220	Commercial Building Construction	Tri-Quest Builders LLC	1	Constru	1
531210	Offices of Real Estate Agents & Brokers	Valley Realty & Management	7	Office_P	7
621340	Offices of Specialty Therapists	Ascent Sports Therapy LLC	3	Medical	3
621492	Kidney Dialysis Centers	RTC - W	15	Medical	15
621511	Medical Laboratories	Laboratory Corp of America	3	Medical	3
532412	Other Heavy Machinery Rental and Leasing	United Rentals Northwest, Inc	7	Other	7
713940	Fitness and Recreational Sports Centers	Eagle Fitness Carson LLC	7	Other	7
443142	Electronics Stores	Ensignal	3	Retail	3
446120	Cosmetic and Beauty Supply Stores	Sally Beauty Supply	7	Retail	7
722511	Full-Service Restaurants	Golden Dragon Restaurant Inc	3	Food_Dr	3
722513	Limited-Service Restaurants	Dickeys Barbecue Pit	7	Food_Dr	7
722515	Snack and Nonalcoholic Beverage Bars	Yogo Frozen Yogurt & Sweet Tre	7	Food_Dr	7
812112	Beauty Salons	Great Clips	7	Retail	7
444110	Home Centers	The Home Depot	95	Retail	95
811219	Other Electronic Equipment Repair	Diamond Surgical Products Inc	3	Retail	3
541613	Marketing Consulting Services	3D Marketing	1	Office_P	1
451120	Hobby, Toy, and Game Stores	Gamestop	7	Retail	7
493110	General Warehousing and Storage	Quality Merchandising Inc	3	Ware_H	3
531311	Residential Property Managers	Alta Royal Vista LLC	3	Office_P	3
541330	Engineering Services	HW Lochner Inc	1	Office_P	1
423850	Service Industry Goods Merchant Whsle	Tahoe Supply Co LLC	25	Ware_H	25
713290	Other Gambling Industries	Dotty's	7	Other	7
444120	Paint and Wallpaper Stores	Kelly-Moore Paint Company, Inc	7	Retail	7

Douglas County/Carson City Regional Travel Demand Model

SIC_CODE	Industry	Trade_Name	Employment	Model_Category	Total_Emp
722513	Limited-Service Restaurants	Mcdonald's	25	Food_Dr	25
923120	Administration of Public Health Programs	Aging and Disability Services	7	Office_G	7
236220	Commercial Building Construction	Shaheen Beauchamp Builders LLC	15	Constru	15
532291	Home Health Equipment Rental	Lincare Inc	15	Other	15
561410	Document Preparation Services	Foxwood Almanor LLC	3	Office_P	3
519130	Internet Publishing & Broadcasting and Web Se	Chargerback.Com	3	Office_P	3
524210	Insurance Agencies and Brokerages	Alpine Insurance Associates	7	Office_P	7
541211	Offices of Certified Public Accountants	Colodny Fields LLP	3	Office_P	3
541820	Public Relations Agencies	Price Target Media Inc	1	Office_P	1
452910	Warehouse Clubs and Supercenters	Wal-Mart Supercenter	250	Super_C	250
541213	Tax Preparation Services	Jackson Hewitt	1	Office_P	1
621320	Offices of Optometrists	Hemmer Eye Care LLC	3	Medical	3
621399	Offices of Misc Health Practitioners	The Clinic at Walmart	3	Medical	3
722513	Limited-Service Restaurants	Mcdonald's	15	Food_Dr	15
812112	Beauty Salons	Smart Style	3	Retail	3
541940	Veterinary Services	Timberline Animal Hospital	3	Office_P	3
443142	Electronics Stores	Spring Mobile	3	Retail	3
522110	Commercial Banking	US Bank National Assoc	7	Office_P	7
623312	Homes for the Elderly	Sierra Place Senior Living	45	Other	45
713940	Fitness and Recreational Sports Centers	Fitness 1440	15	Other	15
238212	Nonresidential Electrical Contractors	Smith Electric	7	Constru	7
238212	Nonresidential Electrical Contractors	Conway Communications Inc	15	Constru	15
532210	Consumer Electronics & Appliances Rental	Aarons Sales & Lease	7	Other	7
238992	All Other Nonresidential Trade Contrs	Artistic Fence Co., Inc.	15	Constru	15
923130	Other Human Resource Program Admin	Aging Services Division	85	Office_G	85
811111	General Automotive Repair	Presto Auto Electric	3	Retail	3
531110	Lessors of Residential Buildings	Imperial Apartments	3	Office_P	3
551114	Managing Offices	Nevada Health Centers, Inc.	35	Office_P	35
814110	Private Households	Kimberly Brune	1	Other	1
722515	Snack and Nonalcoholic Beverage Bars	Sugar Pine Willows Inc	3	Food_Dr	3
813211	Grantmaking Foundations	Criminal Justice Assistance	7	Other	7
236118	Residential Remodelers	Josh Burau Construction	1	Constru	1
332710	Machine Shops	C.A.S Industries	3	Goods_P	3
335999	Miscellaneous Electrical Equipment	Insight Mfg Systems Inc	15	Goods_P	15
423990	All Other Durable Goods Merchant Whsle	Barnes Firearms	3	Ware_H	3
424990	Other Nondurable Goods Merchant Whsle	Angel Americas LLC	3	Ware_H	3

Douglas County/Carson City Regional Travel Demand Model

SIC_CODE	Industry	Trade_Name	Employment	Model_Category	Total_Emp
488190	Other Support Activities, Air Transport	American Warbirds	1	Other	1
531130	Miniwarehouses and Self-Storage Unit	Hobo Hot Springs LLC	3	Office_P	3
541512	Computer Systems Design Services	Axiom Consulting Group	3	Office_P	3
611620	Sports and Recreation Instruction	Silver State Gymnastics Acad	7	School	7
621111	Offices of Physicians, ex. Mental Health	Sierra Family Health Center	25	Medical	25
713990	All Other Amusement and Recreation Ind	Great Basin Sports LLC	1	Other	1
531110	Lessors of Residential Buildings	Encore EMS Ltd	1	Office_P	1
444190	Other Building Material Dealers	Dri Supply	7	Retail	7
541211	Offices of Certified Public Accountants	Freeman & Williams CPA	15	Office_P	15
621111	Offices of Physicians, ex. Mental Health	Nevada Occupational Health Cen	15	Medical	15
488410	Motor Vehicle Towing	Capital Towing Inc	7	Other	7
238161	Residential Roofing Contractors	Don James Roofing	7	Constru	7
336510	Railroad Rolling Stock Manufacturing	Westinghouse Airbrake Company	35	Goods_P	35
811111	General Automotive Repair	Carson Truck & Auto Repair	3	Retail	3
238222	Nonresidential Plumbing/HVAC Contractors	All American Aire Inc	3	Constru	3
518210	Data Processing and Related Services	Landmark Pavers Inc	1	Office_P	1
522291	Consumer Lending	Dollar Loan Center	3	Office_P	3
722513	Limited-Service Restaurants	Round Table Pizza	25	Food_Dr	25
522110	Commercial Banking	Nevada State Bank	7	Office_P	7
722511	Full-Service Restaurants	Joanies Creekside Cafe & Catering	15	Food_Dr	15
447110	Gasoline Stations w/ Convenience Stores	Maverik Country Stores Inc	15	Retail	15
541511	Custom Computer Programming Services	Neotech Solutions Inc	1	Office_P	1
541511	Custom Computer Programming Services	Hewlett Packard Co	3	Office_P	3
541512	Computer Systems Design Services	Precision Technologies Corp	1	Office_P	1
926130	Utility Regulation and Administration	Nuclear Projects Office	3	Office_G	3
531320	Offices of Real Estate Appraisers	Lee B Smith & Associates	3	Office_P	3
541511	Custom Computer Programming Services	Advanced Data Systems Inc	15	Office_P	15
325412	Pharmaceutical Preparation Manufacturing	VRP Manufacturing LLC	75	Goods_P	75
424210	Druggists' Goods Merchant Wholesalers	VRP Brand, LLC	3	Ware_H	3
522110	Commercial Banking	City National Bank	7	Office_P	7
923130	Other Human Resource Program Admin	Division of Welfare & Supportive Svc	250	Office_G	250
541512	Computer Systems Design Services	Itek Solutions Inc	1	Office_P	1
561440	Collection Agencies	Children's Cabinet Inc	3	Office_P	3
921130	Public Finance Activities	Department of Taxation	150	Office_G	150
921190	Other General Government Support	State Public Works Division	3	Office_G	3
334310	Audio and Visual Equipment Manufacturing	Wisdom Audio Corporation	15	Goods_P	15

Douglas County/Carson City Regional Travel Demand Model

SIC_CODE	Industry	Trade_Name	Employment	Model_Category	Total_Emp
532291	Home Health Equipment Rental	Vitalcare Health Services, Inc.	3	Other	3
926150	Licensing/Regulating Commercial Sectors	Insurance Division	75	Office_G	75
522110	Commercial Banking	First Independent Bank Of Nevada	7	Office_P	7
926150	Licensing/Regulating Commercial Sectors	Business and Industry	35	Office_G	35
424690	Other Chemical Merchant Wholesalers	Global Aqua Solutions LLC	1	Ware_H	1
523920	Portfolio Management	Wealth Strategies by Bayliss &	3	Office_P	3
541211	Offices of Certified Public Accountants	Bayliss & Associates LLC	7	Office_P	7
999999	Unknown Industry	Natrona Management LLC	3	Other	3
922130	Legal Counsel and Prosecution	Judicial Discipline Commission	3	Office_G	3
926150	Licensing/Regulating Commercial Sectors	Attorney General's Office	3	Office_G	3
722515	Snack and Nonalcoholic Beverage Bars	Starbucks Coffee	15	Food_Dr	15
722513	Limited-Service Restaurants	Burger King	25	Food_Dr	25
722513	Limited-Service Restaurants	Sonic Drive-In	35	Food_Dr	35
926110	Administration of General Economic Prog	Gaming Control Board	95	Office_G	95
541511	Custom Computer Programming Services	CNET	3	Office_P	3
425120	Wholesale Trade Agents and Brokers	Sterling Air Finance	3	Other	3
488190	Other Support Activities, Air Transport	Carson Aviation Services LLC	7	Other	7
488119	Other Airport Operations	Carson City Airport Authority	3	Other	3
722511	Full-Service Restaurants	Bully's Sports Bar & Grill	25	Food_Dr	25
441120	Used Car Dealers	Super Sport Motors	1	Retail	1
621210	Offices of Dentists	Mark D Funke DDS	3	Medical	3
812112	Beauty Salons	Bella Salon Spa Inc	15	Retail	15
812199	Other Personal Care Services	B Medical Spa/Merle Norman Cos	3	Retail	3
722513	Limited-Service Restaurants	Del Taco	25	Food_Dr	25
339114	Dental Equipment and Supplies Mfg	Wykle Research	7	Goods_P	7
339940	Office Supplies (except Paper) Manufacturing	Walbuck Ltd	3	Goods_P	3
524210	Insurance Agencies and Brokerages	American Family/Kadee Mason	3	Office_P	3
541110	Offices of Lawyers	Michael Suglia Ltd	3	Office_P	3
541110	Offices of Lawyers	Gerald Madison Ltd	3	Office_P	3
624120	Services for the Elderly and Disabled	Interim Homestyles Services	65	Other	65
621111	Offices of Physicians, ex. Mental Health	Physicians Surgery Center of N	15	Medical	15
621111	Offices of Physicians, ex. Mental Health	Sierra Nevada Eye Center Ltd	15	Medical	15
541330	Engineering Services	Lumos & Associates, Inc.	25	Office_P	25
522298	All Other Nondeposit Credit Intermediatn	Capitol City Loan	15	Office_P	15
238141	Residential Masonry Contractors	Mc Masonry	7	Constru	7
922120	Police Protection	Highway Patrol	3	Office_G	3

Douglas County/Carson City Regional Travel Demand Model

SIC_CODE	Industry	Trade_Name	Employment	Model_Category	Total_Emp
541940	Veterinary Services	Lone Mountain Veterinary Inc	25	Office_P	25
531311	Residential Property Managers	Parkway Terraces	7	Office_P	7
541690	Other Technical Consulting Services	Statistical Research Inc	1	Office_P	1
623312	Homes for the Elderly	Amy's Eden Senior Care, LLC	7	Other	7
541330	Engineering Services	Moog Inc	3	Office_P	3
551114	Managing Offices	NV Land and Resource Holdings	15	Office_P	15
531311	Residential Property Managers	Parkway Plaza	7	Office_P	7
624110	Child and Youth Services	Adrienne Tolbert	3	Other	3
445110	Supermarkets and Other Grocery Stores	Save Mart Supermarkets	55	Retail	55
238211	Residential Electrical Contractors	Eagle Valley Electric	1	Constru	1
238211	Residential Electrical Contractors	Eagle Valley Electric	3	Constru	3
551114	Managing Offices	Catseye Holdings LLC	3	Office_P	3
561710	Exterminating and Pest Control Services	Catseye Pest Control	3	Other	3
621111	Offices of Physicians, ex. Mental Health	Nevada Center Inc	15	Medical	15
611610	Fine Arts Schools	Positive Energy	3	School	3
811490	Other Household Goods Repair/Maintenance	Kryptonite Marine LLP	7	Retail	7
525920	Trusts, Estates, and Agency Accounts	Estate of Maurice M Weikel	3	Office_P	3
561730	Landscaping Services	Black Pine Construction	7	Other	7
713910	Golf Courses and Country Clubs	Silver Oak Golf	25	Other	25
236115	New Single-Family Housing Construction	Ridgeline Development LLC	15	Constru	15
238151	Residential Glass/Glazing Contractors	Glass Guru of Carson City, The	3	Constru	3
423930	Recyclable Material Merchant Wholesalers	Eagle Recycling Inc	1	Ware_H	1
611110	Elementary and Secondary Schools	Silver State Charter School	35	School	35
722513	Limited-Service Restaurants	Port of Subs #69	7	Food_Dr	7
423120	New Motor Vehicle Part Merchant Whsle	440 Source Inc	7	Ware_H	7
522291	Consumer Lending	Check N' Go	3	Office_P	3
713210	Casinos (except Casino Hotels)	Comstock Casino	45	Other	45
713290	Other Gambling Industries	Le Roy's Horse & Sports Place	3	Other	3
722511	Full-Service Restaurants	Juans Mexican Grill	15	Food_Dr	15
238111	Residential Poured Foundation Contractor	Burrows Brothers Concrete	7	Constru	7
811121	Automotive Body and Interior Repair	Straight-N-Paint	3	Retail	3
314999	All Other Textile Product Mills	National Award and Trophy	3	Goods_P	3
454111	Electronic Shopping	K9 Medicinals Inc	3	Retail	3
722511	Full-Service Restaurants	Glen Eagles	25	Food_Dr	25
492110	Couriers	Fedex	25	Other	25
722511	Full-Service Restaurants	Micasa Too	1	Food_Dr	1

Douglas County/Carson City Regional Travel Demand Model

SIC_CODE	Industry	Trade_Name	Employment	Model_Category	Total_Emp
722511	Full-Service Restaurants	Micasa Too	15	Food_Dr	15
333243	Sawmill, Woodworking, and Paper Machinery Man	Oliver Machine Products Inc	3	Goods_P	3
441228	Motorcycle, ATV, and All Other Motor Vehicle	Carson Trailer & Auto Sales LLC	3	Retail	3
713940	Fitness and Recreational Sports Centers	Carson Hot Springs	7	Other	7
922150	Parole Offices and Probation Offices	Parole and Probation	55	Office_G	55
238291	Other Residential Equipment Contractors	Linkus Enterprises	15	Constru	15
922150	Parole Offices and Probation Offices	Parole Board	15	Office_G	15
923130	Other Human Resource Program Admin	Child and Family Division	35	Office_G	35
333611	Turbine Generator & Generator Set Units	Langson Energy Inc	1	Goods_P	1
922120	Police Protection	Department of Public Safety	3	Office_G	3
925110	Administration of Housing Programs	Housing Division	15	Office_G	15
926150	Licensing/Regulating Commercial Sectors	Manufactured Housing Division	7	Office_G	7
541330	Engineering Services	Pinpoint Services Group LLC	3	Office_P	3
541330	Engineering Services	Pinpoint Services Inc	7	Office_P	7
623210	Residential Mental Retardation Facility	Chrysalis	45	Other	45
624120	Services for the Elderly and Disabled	Aging and Disability Services	25	Other	25
624120	Services for the Elderly and Disabled	Public and Behavioral Health	45	Other	45
811111	General Automotive Repair	Dana Bordas Automotive	3	Retail	3
523120	Securities Brokerage	Jones, Edward D & Company	3	Office_P	3
424690	Other Chemical Merchant Wholesalers	Airgas NCN, Inc.	3	Ware_H	3
522310	Mortgage and Nonmortgage Loan Brokers	Sierra Financial Mortgage LLC	3	Office_P	3
523920	Portfolio Management	Sierra Financial Advisors LLC	3	Office_P	3
541211	Offices of Certified Public Accountants	Kbca LLC	7	Office_P	7
443141	Household Appliance Stores	Sears Retail Dealer	7	Retail	7
621111	Offices of Physicians, ex. Mental Health	Skin Cancer and Dermatology	15	Medical	15
238292	Other Nonresidential Equipment Contrs	Industrial Logistics Services	15	Constru	15
522220	Sales Financing	Harley-David Financial Svcs	35	Office_P	35
722310	Food Service Contractors	Foodies Catering	3	Food_Dr	3
423610	Wiring & Equipment Merchant Wholesalers	Wedco, Inc.	7	Ware_H	7
541611	Administrative Management Consulting Svc	Franchise World Headquarters L	3	Office_P	3
531311	Residential Property Managers	Dolphin Bay	3	Office_P	3
236118	Residential Remodelers	Lopiccolo Construction	7	Constru	7
454113	Mail-Order Houses	Concours Parts & Accessories	7	Retail	7
336412	Aircraft Engine and Engine Parts	Chromalloy Nevada	150	Goods_P	150
424490	Other Grocery Product Merchant Whsle	Farmer Brothers Company	15	Ware_H	15

Douglas County/Carson City Regional Travel Demand Model

SIC_CODE	Industry	Trade_Name	Employment	Model_Category	Total_Emp
518210	Data Processing and Related Services	Technowledge Networks Inc	3	Office_P	3
333241	Food Product Machinery Manufacturing	San Franciscan Roaster Company	7	Goods_P	7
326122	Plastics Pipe and Pipe Fitting Mfg	LSP Products Group	45	Goods_P	45
611519	Other Technical and Trade Schools	I-Car	3	School	3
423910	Sporting Good Merchant Wholesalers	Kdsko LLC	3	Ware_H	3
541330	Engineering Services	Geocon Consultants Inc	1	Office_P	1
923120	Administration of Public Health Programs	Public and Behavioral Health	65	Office_G	65
923130	Other Human Resource Program Admin	Divsion of Welfare & Supportive Svc	3	Office_G	3
923130	Other Human Resource Program Admin	Health Care Financing & Policy	3	Office_G	3
923130	Other Human Resource Program Admin	Dept of Health and Human Resources	25	Office_G	25
923130	Other Human Resource Program Admin	Child and Family Division	85	Office_G	85
621111	Offices of Physicians, ex. Mental Health	Ted K Matuszewski MD PC	3	Medical	3
561730	Landscaping Services	Jose's Lawn Maintenance	3	Other	3
923120	Administration of Public Health Programs	Public and Behavioral Health	150	Office_G	150
522220	Sales Financing	Eaglemark Savings Bank	75	Office_P	75
522220	Sales Financing	Harley-Davidson Credit Corp	150	Office_P	150
524210	Insurance Agencies and Brokerages	Harley-Davidson Insurance Svcs	7	Office_P	7
522292	Real Estate Credit	Greater Nevada Mortgage Services	1	Office_P	1
713910	Golf Courses and Country Clubs	Eagle Valley Golf Course	45	Other	45
713990	All Other Amusement and Recreation Ind	Capital City Gun Club	3	Other	3
332722	Bolts, Nuts, Screws, Rivets, and Washers	Click Bond Inc	350	Goods_P	350
561740	Carpet and Upholstery Cleaning Services	Doing It Right Carpet Cleaning	3	Other	3
336411	Aircraft Manufacturing	Shadetree Aviation	3	Goods_P	3
624190	Other Individual and Family Services	Sierra Nevada Child and Adoles	1	Other	1
814110	Private Households	Jorge H Perez-Cardona	3	Other	3
337110	Wood Kitchen Cabinets and Countertops	Top Shop, The	3	Goods_P	3
339910	Jewelry and Silverware Manufacturing	Comstock Heritage	7	Goods_P	7
446120	Cosmetic and Beauty Supply Stores	Saloncentric	3	Retail	3
484210	Used Household and Office Goods Moving	High Desert Relocation LLC	3	Other	3
332999	Miscellaneous Fabricated Metal Products	Mustang Manufacturing Inc	15	Goods_P	15
321911	Wood Window and Door Manufacturing	Carson Door LLC	3	Goods_P	3
423830	Industrial Machinery Merchant Whsle	Eze-Lap Diamond	15	Ware_H	15
445110	Supermarkets and Other Grocery Stores	Save Mart Supermarkets	45	Retail	45
447110	Gasoline Stations w/ Convenience Stores	AM/PM 83213	7	Retail	7
522320	Financial Transaction Process/Clearing	Eccogen	1	Office_P	1
331512	Steel Investment Foundries	PCC Structurals Carson City	250	Goods_P	250

Douglas County/Carson City Regional Travel Demand Model

SIC_CODE	Industry	Trade_Name	Employment	Model_Category	Total_Emp
551114	Managing Offices	Precision Castparts Co	3	Office_P	3
621493	Freestanding Emergency Medical Centers	Nevada Endoscopy Management	45	Medical	45
621111	Offices of Physicians, ex. Mental Health	Carson Surgical Group	15	Medical	15
621111	Offices of Physicians, ex. Mental Health	Carson Urologists Ltd Cunningh	35	Medical	35
621511	Medical Laboratories	Our Lab	1	Medical	1
326199	All Other Plastics Product Manufacturing	Impact International Inc	15	Goods_P	15
621111	Offices of Physicians, ex. Mental Health	Capitol Surgery	3	Medical	3
621111	Offices of Physicians, ex. Mental Health	Capitol Urology Inc	7	Medical	7
621210	Offices of Dentists	Michael G Almaraz DDS Ltd	15	Medical	15
481211	Nonscheduled Air Passenger Chartering	Maverick Aviation	1	Other	1
481211	Nonscheduled Air Passenger Chartering	EI Aero Service Inc.	15	Other	15
611512	Flight Training	Bristow Academy Inc	3	School	3
238221	Residential Plumbing/HVAC Contractors	R & S Heating & Appliance	3	Constru	3
561720	Janatorial Services	Spring Cleaning Inc	3	Other	3
531190	Lessors of Other Real Estate Property	Cottonwood Mobile Home Pk Inc	3	Office_P	3
721110	Hotels (except Casino Hotels) and Motels	Hampton Inn & Suites Carson Ci	25	Hotel_NG	25
561730	Landscaping Services	Green Thumb Lawn Service	3	Other	3
332431	Metal Can Manufacturing	Allcan West LLC	3	Goods_P	3
334310	Audio and Visual Equipment Manufacturing	BG Radia Corporation	15	Goods_P	15
423120	New Motor Vehicle Part Merchant Whsle	IBS of Western Nevada	15	Ware_H	15
425120	Wholesale Trade Agents and Brokers	Wholesale and Retail Battery S	3	Other	3
333999	Miscellaneous General Purpose Machinery	Plasma Etch Inc	25	Goods_P	25
111411	Mushroom Production	Aloha Medicinals Inc	35	Goods_P	35
332999	Miscellaneous Fabricated Metal Products	Duro Manufacturing Inc	25	Goods_P	25
311812	Commercial Bakeries	Insight Industries Inc	15	Goods_P	15
334515	Electricity & Signal Testing Instruments	R E Dixon Inc	7	Goods_P	7
333996	Fluid Power Pump and Motor Manufacturing	Rice Hydro Inc	15	Goods_P	15
336413	Other Aircraft Parts and Equipment	NAFCO USA LLC	25	Goods_P	25
441110	New Car Dealers	Michael Hohl Honda-Subaru	95	Retail	95
334111	Electronic Computer Manufacturing	Cubix Corporation	15	Goods_P	15
622310	Other Hospitals	Sierra Surgery & Imaging LLC	150	Medical	150
454310	Fuel Dealers	Amerigas Propane, Inc.	7	Retail	7
442210	Floor Covering Stores	Sierra Floor Coverings Inc	7	Retail	7
327991	Cut Stone & Stone Product Manufacturing	Perfection Connection Marble A	15	Goods_P	15
326113	Nonpackaging Plastics Film and Sheet	ESP West LLC	7	Goods_P	7
333511	Industrial Mold Manufacturing	High Desert Tool & Mold Mfg LLC	7	Goods_P	7

Douglas County/Carson City Regional Travel Demand Model

SIC_CODE	Industry	Trade_Name	Employment	Model_Category	Total_Emp
333999	Miscellaneous General Purpose Machinery	Cinc Industries Inc	15	Goods_P	15
238221	Residential Plumbing/HVAC Contractors	Jims Plumbing & Heating	3	Constru	3
236115	New Single-Family Housing Construction	Golden Bear Construction Co	3	Constru	3
423720	Plumbing Goods Merchant Wholesalers	Sea Group Industries	3	Ware_H	3
454113	Mail-Order Houses	Golden State Parts	1	Retail	1
326199	All Other Plastics Product Manufacturing	Mattox Machine and Molding Inc	3	Goods_P	3
447110	Gasoline Stations w/ Convenience Stores	Terribles	7	Retail	7
424720	Other Petroleum Merchant Wholesalers	Carson Valley Oil Company	7	Ware_H	7
561720	Janatorial Services	Sierra Carpet Cleaning	7	Other	7
722513	Limited-Service Restaurants	Taqueria Uruapan	3	Food_Dr	3
531120	Lessors of Nonresidential Buildings	Tri-Star Inc	3	Office_P	3
551114	Managing Offices	Veriflo	3	Office_P	3
541620	Environmental Consulting Services	Environ	3	Office_P	3
811121	Automotive Body and Interior Repair	Auto Graphics	3	Retail	3
621111	Offices of Physicians, ex. Mental Health	Carson Tahoe Cardiology, LLC	35	Medical	35
621111	Offices of Physicians, ex. Mental Health	Carson Medical Group	35	Medical	35
621210	Offices of Dentists	James L Pincock MD DMD	3	Medical	3
213114	Support Activities for Metal Mining	OR Exploration Services Inc	3	Other	3
335314	Relay & Industrial Control Manufacturing	Western Servo Design Inc	3	Goods_P	3
484220	Other Specialized Trucking, Local	Cinderlite Trucking Corp	45	Other	45
999999	Unknown Industry	Alphabio Inc	3	Other	3
332911	Industrial Valve Manufacturing	Aquasyn California LLC	15	Goods_P	15
333994	Industrial Process Furnaces and Ovens	Cress Mfg Company Inc	15	Goods_P	15
333612	Speed Changer, Drive, and Gear Mfg	C.G.I. Inc	75	Goods_P	75
336310	Motor Vehicle Gasoline Engine and Engine Part	Dura-Bond Bearing Company	65	Goods_P	65
326291	Mechanical Rubber Product Manufacturing	Redco	35	Goods_P	35
332919	Other Metal Valves and Pipe Fittings	Cabletec Mfg Corp	7	Goods_P	7
332119	Metal Crown, Closure, and Other Metal Stampin	Custom Stamping Inc	25	Goods_P	25
327331	Concrete Block and Brick Manufacturing	Basalite Block Carson City	45	Goods_P	45
238991	All Other Residential Trade Constructors	Jacoboni Plastering & Tile	7	Constru	7
323111	Commercial Gravure Printing	Monarch Direct LLC	3	Goods_P	3
332919	Other Metal Valves and Pipe Fittings	US Coupler Inc	7	Goods_P	7
423420	Office Equipment Merchant Wholesalers	Calculated Industries Inc	35	Ware_H	35
541720	Social Science/Humanities Research	Nuveen Investments	3	Office_P	3
454310	Fuel Dealers	Campora Propane Nevada	7	Retail	7
561720	Janatorial Services	Pro-5 Industrial Services	7	Other	7

Douglas County/Carson City Regional Travel Demand Model

SIC_CODE	Industry	Trade_Name	Employment	Model_Category	Total_Emp
336390	Other Motor Vehicle Parts Manufacturing	T & D Machine Products Inc	65	Goods_P	65
336310	Motor Vehicle Gasoline Engine and Engine Part	Bill Miller Engineering Ltd	25	Goods_P	25
711219	Other Spectator Sports	Bill Miller Racing LLC	3	Other	3
623210	Residential Mental Retardation Facility	Eagle Valley Childrens Home	85	Other	85
621111	Offices of Physicians, ex. Mental Health	Carson Tahoe Cancer Center	7	Medical	7
621111	Offices of Physicians, ex. Mental Health	Radiation Oncology Associates	15	Medical	15
334515	Electricity & Signal Testing Instruments	Micromanipulator Company LLC,T	15	Goods_P	15
488410	Motor Vehicle Towing	Cal-Neva Transport & Tow Inc	3	Other	3
336510	Railroad Rolling Stock Manufacturing	Graham White Manufacturing Co	15	Goods_P	15
333515	Machine Tool Cutters and Accessories	Sierra Mold Corporation	3	Goods_P	3
423830	Industrial Machinery Merchant Whsle	Screen Printing Superstore	1	Ware_H	1
454111	Electronic Shopping	Blank Athletics	15	Retail	15
236220	Commercial Building Construction	Hunt Group Inc	3	Constru	3
518210	Data Processing and Related Services	Carson Tahoe Physician Hospita	3	Office_P	3
541219	Other Accounting Services	Sierra Physician Management In	3	Office_P	3
551114	Managing Offices	Carson Tahoe Health System	85	Office_P	85
561320	Temporary Help Services	Delta Flex Partners Llc	3	Office_P	3
561440	Collection Agencies	Resolution Consulting Inc	7	Office_P	7
621111	Offices of Physicians, ex. Mental Health	Clinton M Erickson MD PC	3	Medical	3
621111	Offices of Physicians, ex. Mental Health	Carson-Tahoe Pathology Inc	3	Medical	3
621111	Offices of Physicians, ex. Mental Health	Carson Tahoe Urgent Care Assoc	3	Medical	3
621111	Offices of Physicians, ex. Mental Health	Lake Tahoe Regional Hospitalis	25	Medical	25
622110	General Medical and Surgical Hospitals	Carson Tahoe Hospital	1250	Medical	1250
238111	Residential Poured Foundation Contractor	Centerpoint Concrete Pumping	3	Constru	3
321918	Other Millwork (including Flooring)	Complete Millwork Services Inc	150	Goods_P	150
323111	Commercial Gravure Printing	Digital Wood Graphics LLC	3	Goods_P	3
531110	Lessors of Residential Buildings	Heartland Realty Investors Inc	7	Office_P	7
332994	Small Arms Manufacturing	Omega Powersports LLC	1	Goods_P	1
238321	Residential Painting Contractors	C & C Painting, Llc	3	Constru	3
541214	Payroll Services	Sunopta Companies Inc	3	Office_P	3
311340	Nonchocolate Confectionery Manufacturing	Sunopta Grains and Foods Inc	65	Goods_P	65
332311	Prefabricated Metal Building & Component	American Buildings Company	150	Goods_P	150
484230	Other Specialized Trucking, Long-Dist	ABC Transportation Inc	3	Other	3
332710	Machine Shops	Specialty Honing Llc	3	Goods_P	3
337215	Showcases, Partition, Shelving & Lockers	Acrafab Inc	3	Goods_P	3
524210	Insurance Agencies and Brokerages	Anderson Resource Associates	1	Office_P	1

Douglas County/Carson City Regional Travel Demand Model

SIC_CODE	Industry	Trade_Name	Employment	Model_Category	Total_Emp
541712	Research and Development in the Physical, Eng	Electrical Density Gauge	1	Office_P	1
541712	Research and Development in the Physical, Eng	Greatbatch Ltd	3	Office_P	3
561730	Landscaping Services	Cutting Edge Lawn and Landscap	3	Other	3
238912	Nonresidential Site Preparation Contrs	Als Excavating & Grading Inc	7	Constru	7
333991	Power-Driven Handtool Manufacturing	Jiffy Air Tool Inc	55	Goods_P	55
236118	Residential Remodelers	Sierra Design Construction LLC	7	Constru	7
238221	Residential Plumbing/HVAC Contractors	Sierra Design Heating & Air Co	3	Constru	3
333514	Special Tools, Dies, Jigs, and Fixtures	Ameriken Die Supply Inc	25	Goods_P	25
488410	Motor Vehicle Towing	Valley Towing	7	Other	7
488410	Motor Vehicle Towing	Silver State Towing	15	Other	15
541611	Administrative Management Consulting Svc	Ritter Consulting Associates I	1	Office_P	1
238211	Residential Electrical Contractors	Sierra Nevada Electric Llc	7	Constru	7
334118	Computer Terminal and Other Computer Peripher	Carson Mfg Inc	15	Goods_P	15
561990	All Other Support Services	Browns River Marotti Co	7	Other	7
333993	Packaging Machinery Manufacturing	Beverage Technologies Inc	3	Goods_P	3
811310	Commercial Machinery Repair/Maintenance	Commercial Grinding Ltd	3	Retail	3
511210	Software Publishers	Wireless Generation Inc	3	Office_P	3
332312	Fabricated Structural Metal Mfg	AAA Mfg Inc	7	Goods_P	7
334416	Electronic Coils, Transformer & Inductor	Eclipse Nanomed LLC	3	Goods_P	3
326220	Rubber and Plastics Hoses and Belting	DYC Supply Co	1	Goods_P	1
238212	Nonresidential Electrical Contractors	Briggs Electric Inc	55	Constru	55
339950	Sign Manufacturing	Tischler Plastics	15	Goods_P	15
423140	Used Motor Vehicle Part Merchant Whsle	Pick-N-Pull	15	Ware_H	15
314999	All Other Textile Product Mills	Team Sports Ink	25	Goods_P	25
337110	Wood Kitchen Cabinets and Countertops	Thomas Built Cabinets	3	Goods_P	3
336413	Other Aircraft Parts and Equipment	Specline Nevada Inc	65	Goods_P	65
811122	Automotive Glass Replacement Shops	Low Price Auto Glass	3	Retail	3
339950	Sign Manufacturing	Custom Sign & Crane	7	Goods_P	7
311812	Commercial Bakeries	Nature's Bakery	150	Goods_P	150
423840	Industrial Supplies Merchant Wholesalers	Western Tool & Supply Co	7	Ware_H	7
331313	Alumina Refining and Primary Aluminum Product	MC-21 Inc	1	Goods_P	1
332216	Saw Blade and Handtool Manufacturing	MTG Inc	7	Goods_P	7
321918	Other Millwork (including Flooring)	B & C Cabinet & Millwork Inc	35	Goods_P	35
334416	Electronic Coils, Transformer & Inductor	Circuit Functions Inc	15	Goods_P	15
334513	Industrial Process Variable Instruments	Universal Analyzers Inc	45	Goods_P	45

Douglas County/Carson City Regional Travel Demand Model

SIC_CODE	Industry	Trade_Name	Employment	Model_Category	Total_Emp
551114	Managing Offices	Obcorp LLC	3	Office_P	3
561422	Telemarketing Bureaus	Fluke Biomedical/Networks/Elec	1	Office_P	1
238221	Residential Plumbing/HVAC Contractors	Abc Heating & Sheet Metal	15	Constru	15
236220	Commercial Building Construction	Paul Brooks General Contractor	7	Constru	7
423120	New Motor Vehicle Part Merchant Whsle	Classic Automotive Specialties	3	Ware_H	3
511130	Book Publishers	Change Companies, The	25	Office_P	25
611710	Educational Support Services	Train for Change Inc	1	School	1
721211	RV Parks and Campgrounds	Comstock Cntry RV Resort Llc	3	Other	3
441320	Tire Dealers	Carson Used Tire & Wheel	3	Retail	3
238221	Residential Plumbing/HVAC Contractors	Hart Plumbing Services Inc	3	Constru	3
721110	Hotels (except Casino Hotels) and Motels	Silver Queen Inn	3	Hotel_NG	3
323111	Commercial Gravure Printing	Parker Album Company	3	Goods_P	3
561790	Other Services to Buildings & Dwellings	Uni-Steam LLC	3	Other	3
238321	Residential Painting Contractors	Clays Custom Painting & Drywal	1	Constru	1
531130	Miniwarehouses and Self-Storage Unit	Baron's RV & Boat Storage	3	Office_P	3
531190	Lessors of Other Real Estate Property	Carson Highlands	3	Office_P	3
484220	Other Specialized Trucking, Local	Pierce Fire	1	Other	1
238191	Other Residential Exterior Contractors	Paramount Iron & Handrail Inc	7	Constru	7
451110	Sporting Goods Stores	Carson Armory	3	Retail	3
238212	Nonresidential Electrical Contractors	Creekside Electrical Contracto	7	Constru	7
624110	Child and Youth Services	Roberta K Simon	3	Other	3
541611	Administrative Management Consulting Svc	Ryan and Ryan Mktg Inc	3	Office_P	3
811111	General Automotive Repair	Amigo Auto Repair	3	Retail	3
531130	Miniwarehouses and Self-Storage Unit	All American Self Storage LLC	3	Office_P	3
339113	Surgical Appliance and Supplies Mfg	Ultra Prosthetics & Orthotics	3	Goods_P	3
238341	Residential Tile/Terrazzo Contractors	Majestic Marble & Tile	25	Constru	25
332721	Precision Turned Product Manufacturing	Underwood & Sons Corp	7	Goods_P	7
337212	Custom Architectural Woodwork & Millwork	Silver State Millwork LLC	3	Goods_P	3
332722	Bolts, Nuts, Screws, Rivets, and Washers	Mettec	7	Goods_P	7
238352	Nonresidential Finish Carpentry Contrs	BW Cabinets and Doors Inc	3	Constru	3
332994	Small Arms Manufacturing	KKM Precision Inc	7	Goods_P	7
333993	Packaging Machinery Manufacturing	Pegasus Food Machinery Corp	3	Goods_P	3
238911	Residential Site Preparation Contractors	Fereira Construction	1	Constru	1
814110	Private Households	Holly and Michael Song	1	Other	1
532411	Transportation Equipment Rental/Leasing	Aero Leasing	3	Other	3
238171	Residential Siding Contractors	Beautiful Homes	3	Constru	3

Douglas County/Carson City Regional Travel Demand Model

SIC_CODE	Industry	Trade_Name	Employment	Model_Category	Total_Emp
237120	Oil and Gas Pipeline Construction	Maverick Engineering	3	Constru	3
238311	Residential Drywall Contractors	Advanced Drywall Repair	3	Constru	3
213114	Support Activities for Metal Mining	Globalmin LLC	1	Other	1
236220	Commercial Building Construction	Northern Sierra Const Inc	3	Constru	3
236220	Commercial Building Construction	Bison Construction	15	Constru	15
541618	Other Management Consulting Services	Cleanroom Mgt Assoc Inc	3	Office_P	3
813910	Business Associations	Northamerican Transportation	3	Office_P	3
531120	Lessors of Nonresidential Buildings	Fallon Old Town LLC	3	Office_P	3
541690	Other Technical Consulting Services	Caadys Inc	3	Office_P	3
236220	Commercial Building Construction	Coker Development-Nev Inc	3	Constru	3

Appendix D

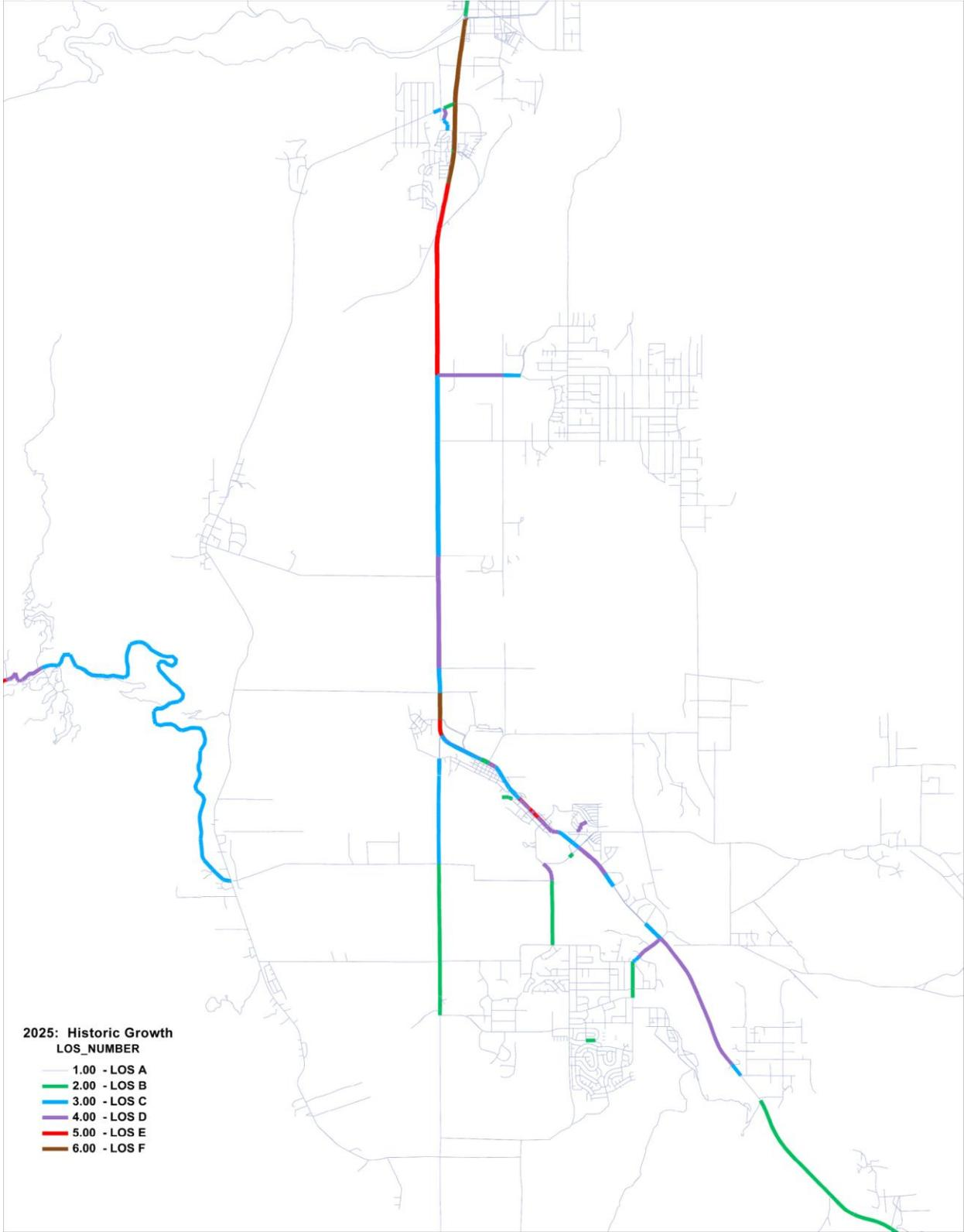



APPENDIX B

**V&T Railroad Right-of-Way Maps and
Selected Plan Sheets from the
Carson & Eagle Valley Railroad Route
Alignment Concepts Report**

Appendix B: V&T Railroad Right-of-Way Maps and Selected Plan Sheets from the Carson & Eagle Valley Railroad Route Alignment Concepts Report

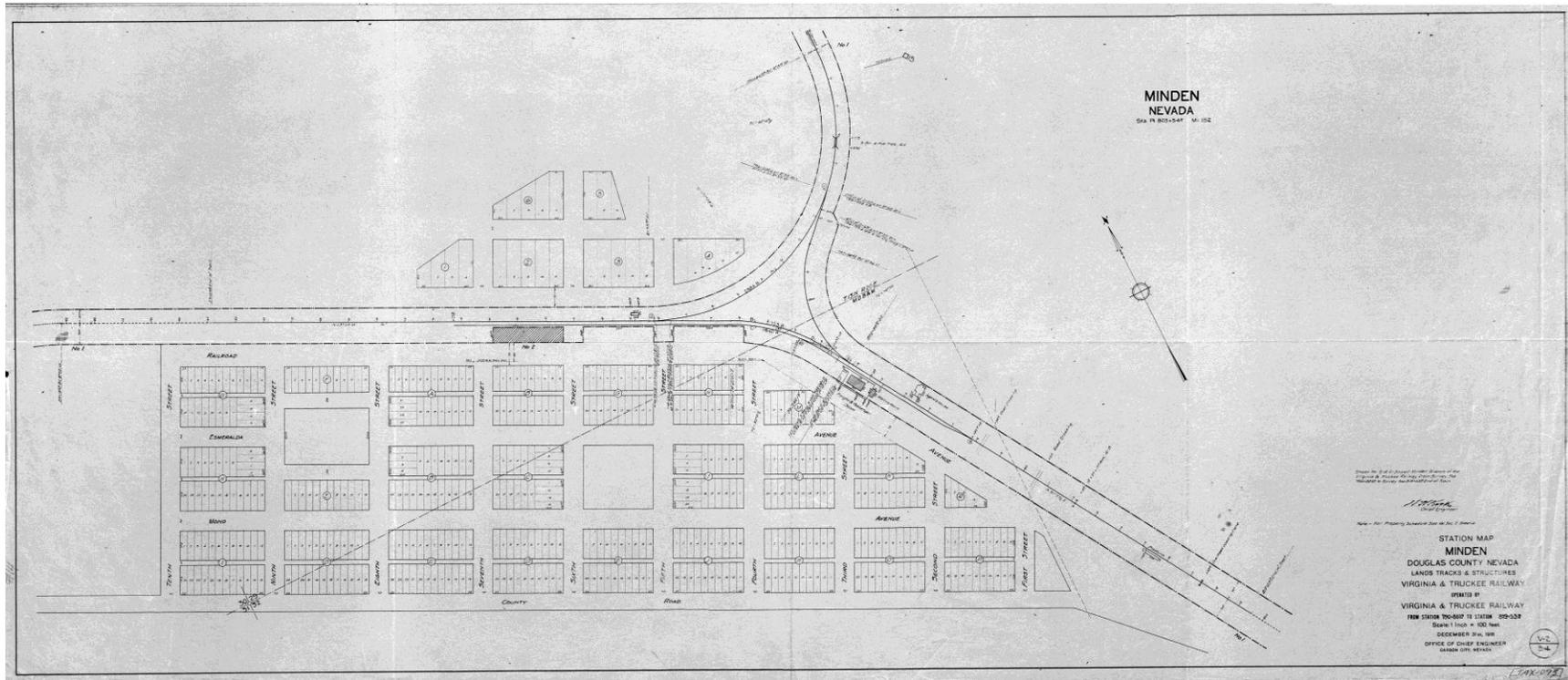

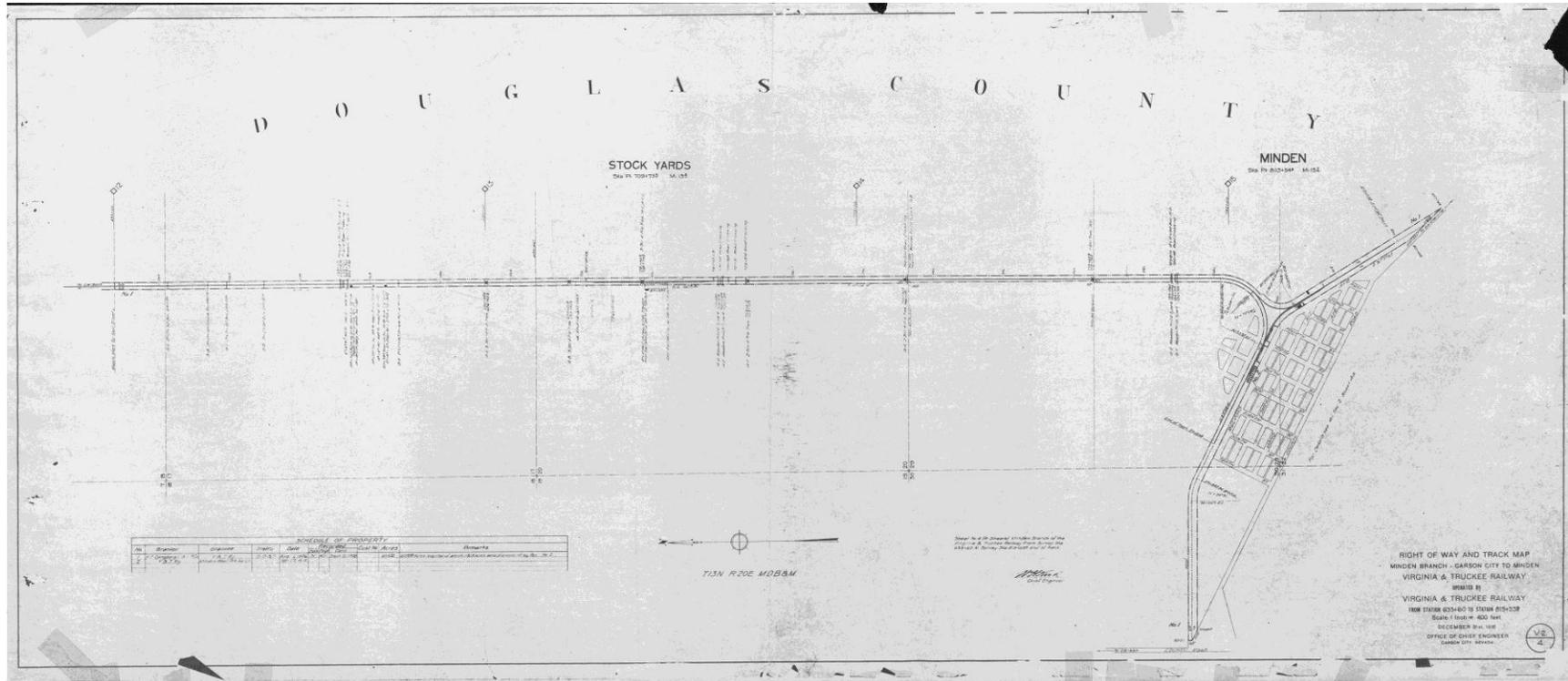

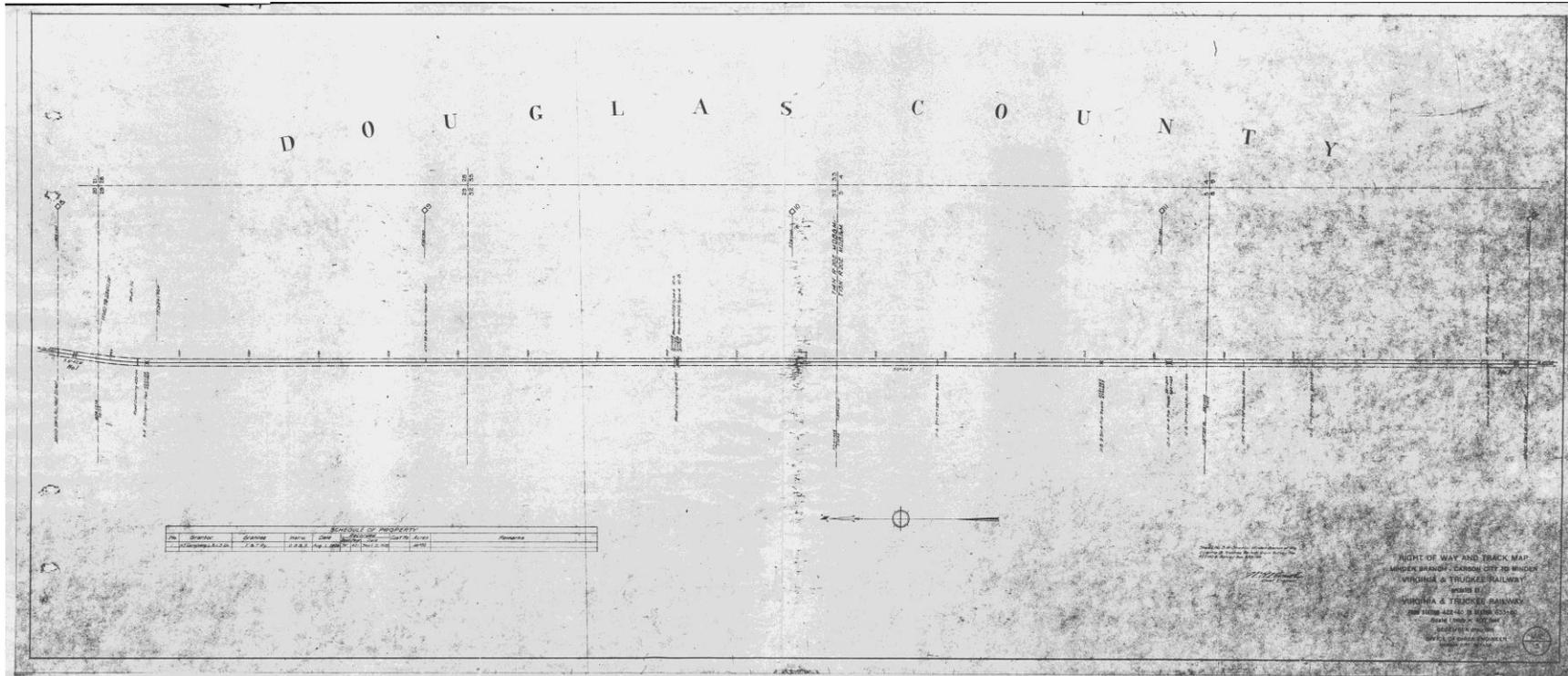

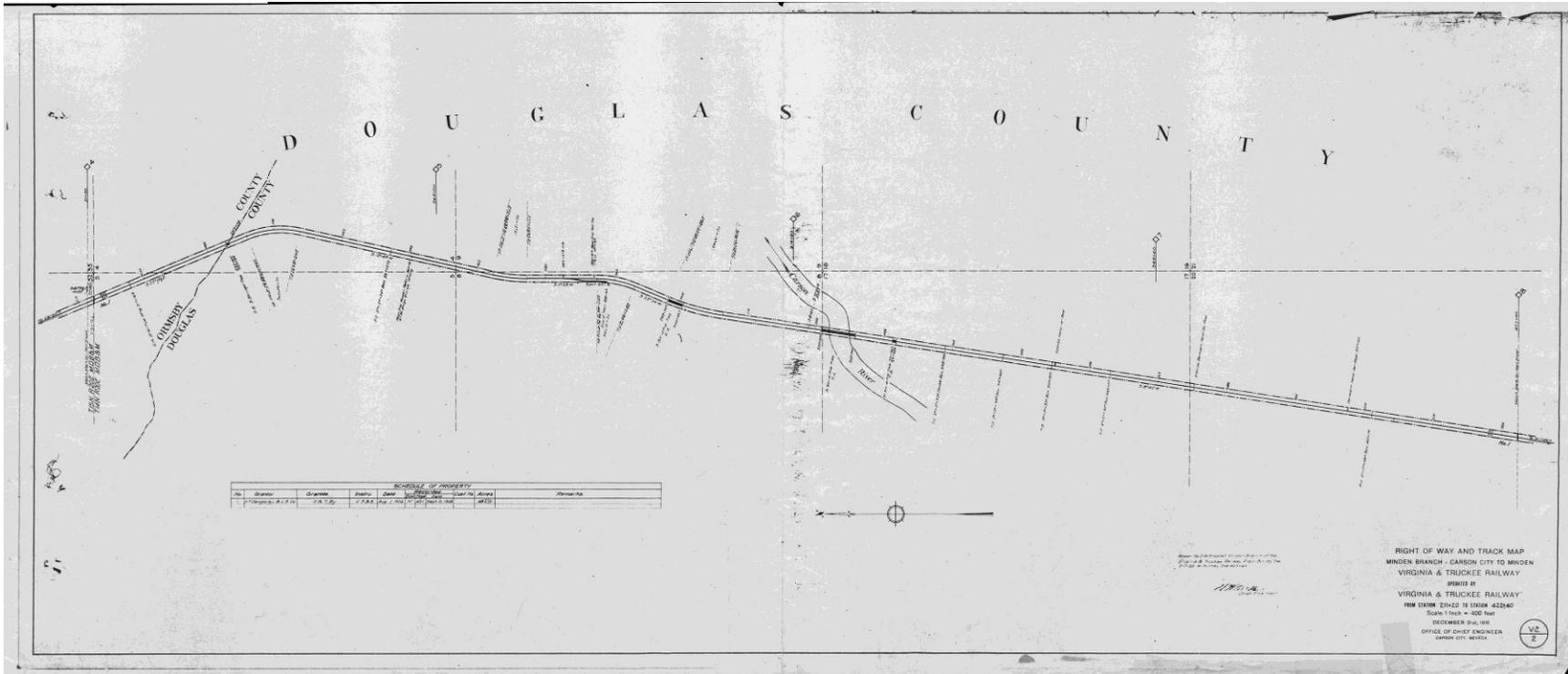

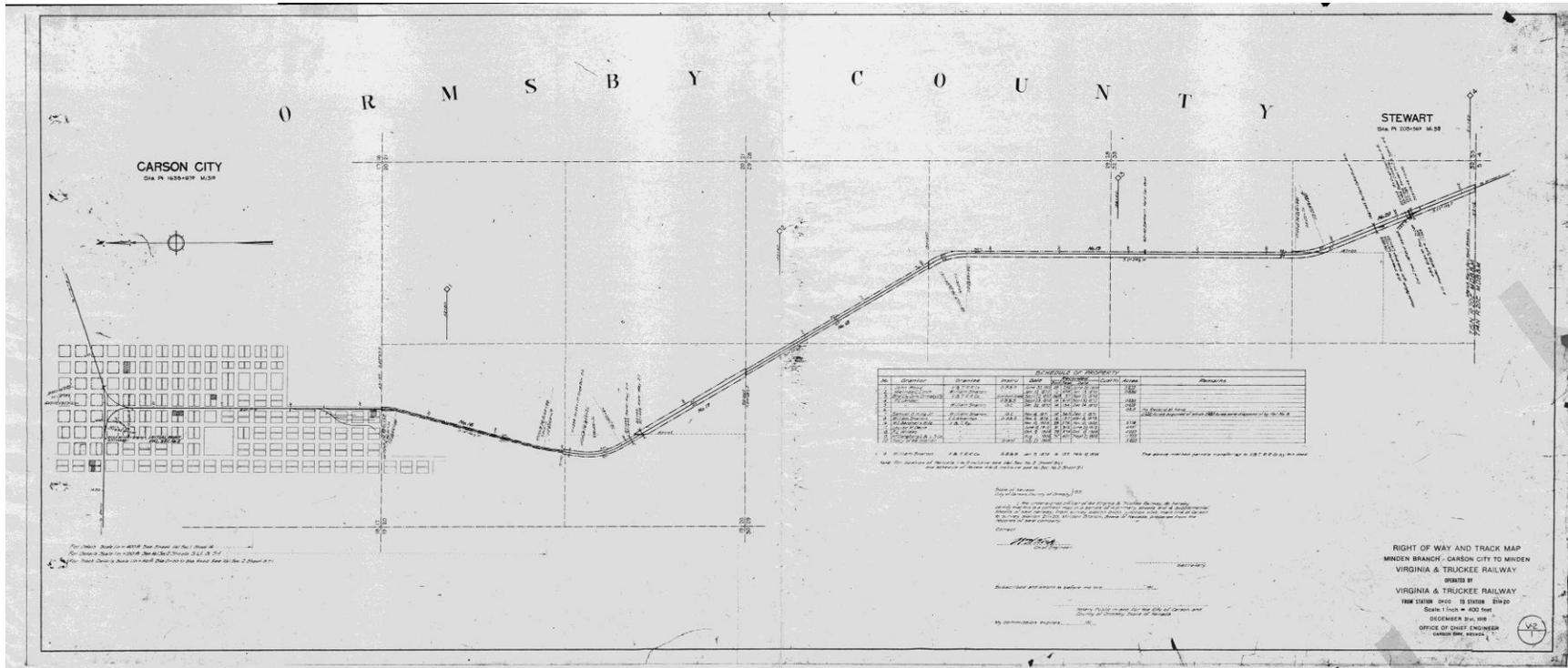

Carson Valley & Eagle Valley Railroad Route Alignment Concepts

A Conceptual Analysis of Possible Passenger Rail Routes in the
Carson & Eagle Valleys, Nevada
Final Report
June, 2015



PREPARED FOR



BENTLY ENTERPRISES LLC
1597 ESERALDA AVENUE
MINDEN, NV 89423



DOUGLAS COUNTY, NEVADA
1594 ESERALDA AVENUE
MINDEN, NV 89423



CARSON CITY, NEVADA
CITY HALL
201 NORTH CARSON STREET
CARSON CITY, NV 89701

PREPARED BY



CARSON CITY OFFICE LOCATION:
3476 EXECUTIVE POINTE WAY, SUITE 12
CARSON CITY, NV 89706
PHONE: (775) 882.5630
FAX: (775) 885.7282



Vision Rail Carson & Douglas 2030?

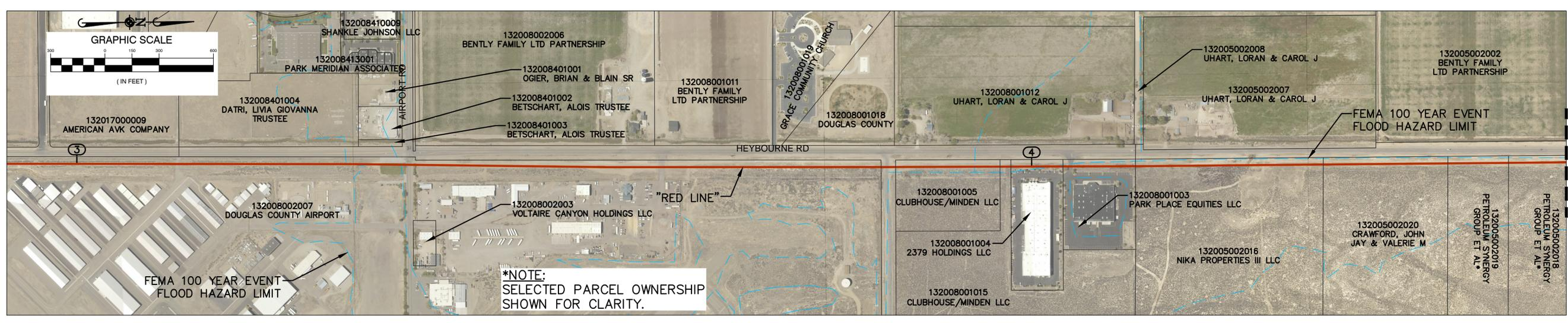
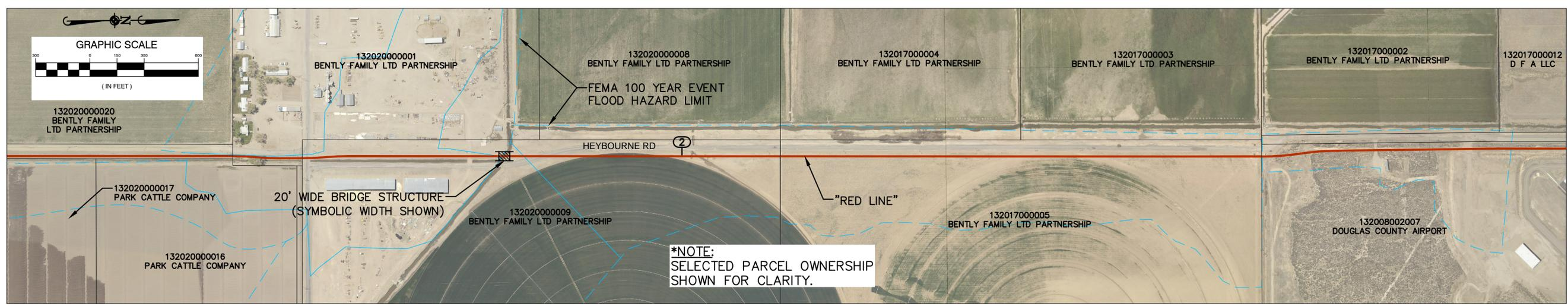
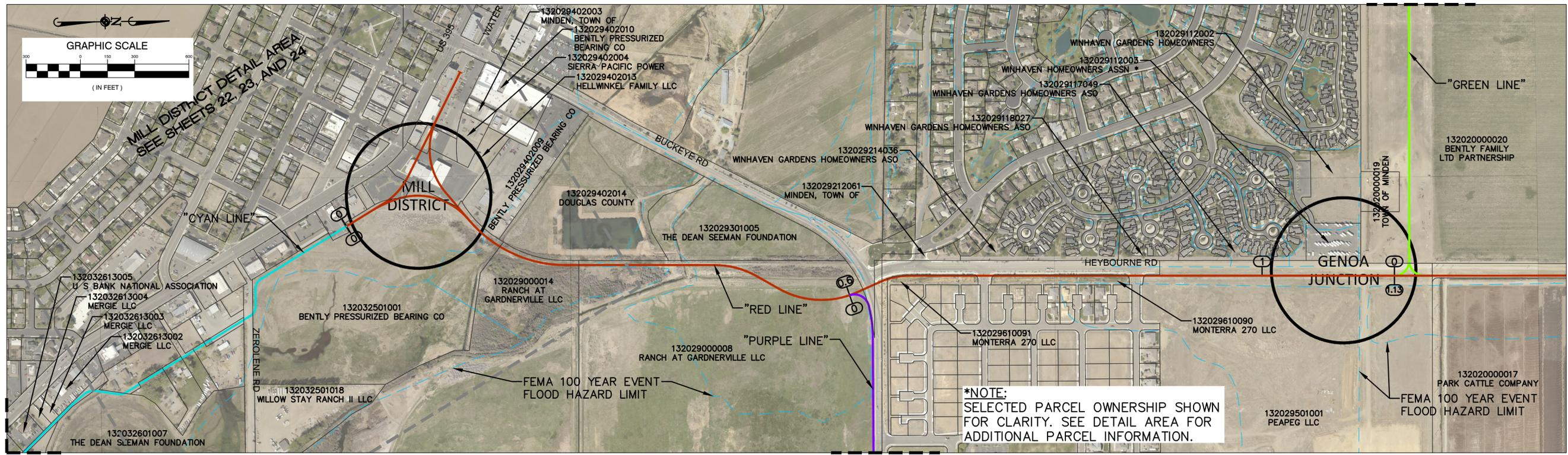

NO.	DATE	REVISIONS	CHECKED BY	DRAWN BY	MSK	KLD

Manhard
CONSULTING LTD

3478 Eschscholtz Pkwy, Suite 100, Carson City, NV 89706 | Tel: (775) 885-7888 | www.manhard.com
Civil Engineers • Surveyors • Water Resources Engineers • Water & Wastewater Engineers
Construction Management • Environmental Sciences • Landscape Architecture

CARSON & EAGLE VALLEY RAILROAD ROUTE CONCEPTS
DOUGLAS COUNTY, NV & CARSON CITY, NV
RED LINE



PROJ. MGR.:	KLD
PROJ. ASSOC.:	SWT
DRAWN BY:	SWT
CHECKED BY:	KLD
DATE:	NOV. 2014
SCALE:	AS SHOWN

SHEET
7 OF **24**

VTDONV

PRELIMINARY

SEE SHEET 8

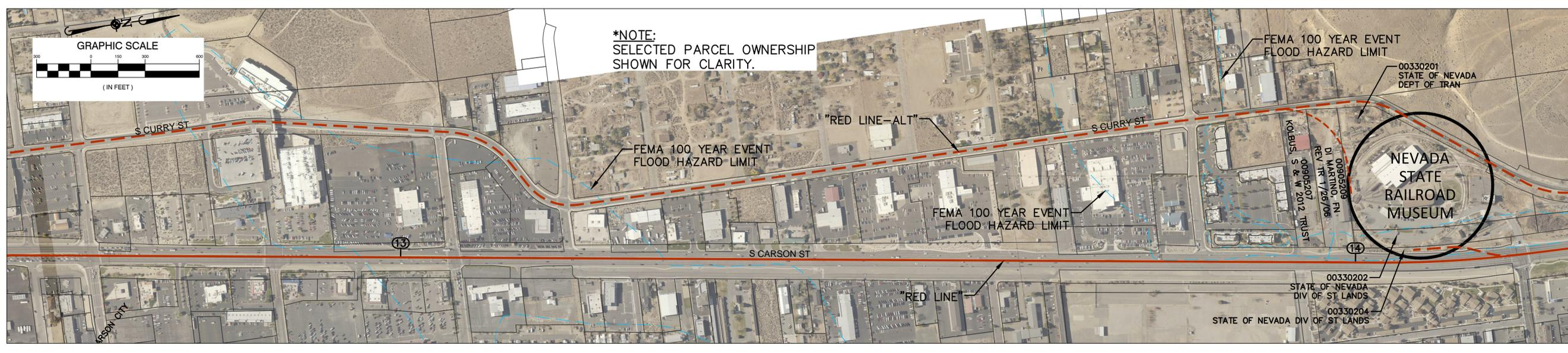
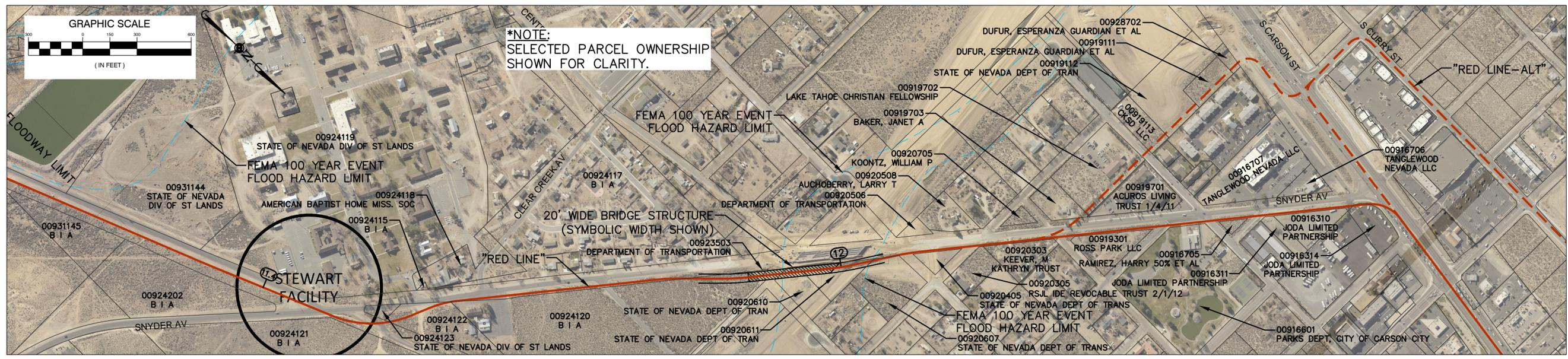
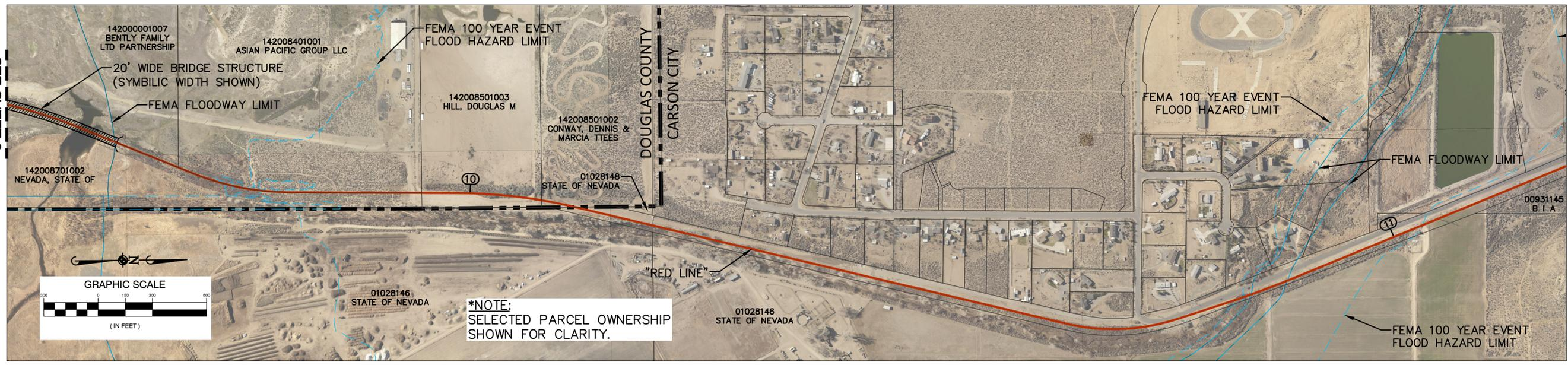

SEE SHEET 10

NO.	DATE	REVISIONS	CHECKED BY

Manhard
CONSULTING LTD

3478 Eschscholtz Pkwy, Suite 100, Carson City, NV 89706 tel: (775) 885-8833 fax: (775) 885-7888 www.manhard.com
Civil Engineers - Surveyors - Water Resources Engineers - Water & Wastewater Engineers
Construction Managers - Environmental Scientists - Landscape Architects - Planners

CARSON & EAGLE VALLEY RAILROAD ROUTE CONCEPTS
DOUGLAS COUNTY, NV & CARSON CITY, NV
RED LINE

PROJ MGR.: KLD
PROJ ASSOC.: SWT
DRAWN BY: SWT
CHECKED BY: KLD
DATE: NOV. 2014
SCALE: AS SHOWN

SEAL: KENNETH L. DORR
Exp: 12/31/14
CIVIL
No. 8035

November 12, 2014 - 17:12 Dwg Name: P:\VTD\CNV\Arch\Email_Downloads\Plan_Sect\Plan_Sheets.dwg Updated By: S\slamon



APPENDIX C

Douglas County Transportation Plan Draft Comments



2017 Douglas County Transportation Plan

Comments Received Regarding the Draft Transportation Plan and Final Disposition

1. **Comment:** Page 80, Airport Master Plan is not on County website. It is on Airport website www.mindentahoeairport.com. I would like to send you the jpg of our actual logo and an updated airport layout map. What about State plan for traffic light at airport road?

Author: Bobbi Thompson, Minden-Tahoe Airport Manager, in writing at public meeting on 10/20/16.

Response: Language on page 80 was revised to indicate that the Airport Master Plan is available on the Minden-Tahoe Airport website, and that the Douglas County website contains a link to the Minden-Tahoe Airport website. NDOT staff has indicated that they are currently pursuing right-of-way for improvements at the US 395/Airport Road intersection, and that they intend to advertise the project for construction in 2017.
2. **Comment:** NDOT is going to piddle around with all their "counts" instead of solving the truck problem with the bypass. The current bypass route is in the wrong location. Follow the pioneers and bridge where they did, go behind Hot Springs Mountain and go along the Pine Nut foothills to the other side of Ruhenstroth. It will require minimum impact to Douglas County.

Author: Jim Madsen, Douglas County Planning Commissioner, in writing at public meeting on 10/20/16.

Response: This comment appears to be similar to Commissioner Penzel's comment, listed as #5 below. This information was included in the packets for the Planning Commission and the Board of County Commissioners for their consideration on November 8 and December 1, 2016 respectively. No change was made to the draft Transportation Plan in response to this comment.
3. **Comment:** Not sure if one of you can answer this, but I was wondering why the pictures on page 9 and 10 of the plan are labeling it "Carson Valley" and showing Carson City and Lake Tahoe?

Author: Coleen Thran-Zepeda, Development Coordinator for Douglas County, via email on 10/20/16 to Mimi Moss.

Response: The titles of figures 2.1, 2.2 and 2.3 were revised to include Carson City and Lake Tahoe.
4. **Comment:** Page 83 of the Transportation Plan states: *On December 3, 2015, the Board of Commissioners approved Ordinance No. 2015-1446, increasing its county option motor vehicle fuel tax from \$0.04 to \$0.09 per gallon on gasoline and gasohol (NRS*

373.030). On that date, the Board also approved Ordinance 2015-1445, which imposed an additional \$0.25 sales tax with an effective date of April 1, 2016. It is expected to generate \$1,500,000 annually for infrastructure use, including a portion for road maintenance and road construction projects.

I think this statement is false: "On that date, the Board also approved Ordinance 2015-1445, which imposed an additional \$0.25 sales tax with an effective date of April 1, 2016".

Author: Steven Thaler, Douglas County Commissioner via email to Mimi Moss on 10/19/16.

Response: The statement is false. The language on page 83 was revised to indicate that Ordinance 2015-1445 failed on its second reading on December 3, 2015.

5. **Comment:** Barry Penzel submitted a map showing an alternate alignment for the Eastside Bypass entirely on BLM land in Douglas County, along with an explanation of the route.

Author: Barry Penzel, Douglas County Commissioner to Erik Nilssen.

Response: This information was included in the packets for the Planning Commission and the Board of County Commissioners for their consideration on November 8 and December 1, 2016 respectively. No change was made to the draft Transportation Plan in response to this comment. (See also comment #7.)

6. **Comment:** Eugene Russell suggested a change in the alignment of the Eastside Bypass that would move it away from his home on Fish Springs Road via email correspondence with Erik Nilssen, County Engineer.

Author: Eugene Russell, a Douglas County resident via email to Eric Nilssen.

Response: This information was included in the packets for the Planning Commission and the Board of County Commissioners for their consideration on November 8 and December 1, 2016 respectively. No change was made to the draft Transportation Plan in response to this comment.

7. **Comment:** Barry Penzel stated he wants to convince the RTC to change the alignment of the future Eastside Bypass. He suggested that the bypass connect to US 395 south of Gardnerville near the China Springs Road intersection with the highway. Connecting at this point would facilitate an alignment that could be entirely on federal land, without crossing any private or BIA lands. He stated that the road could be funded by constructing it as a toll road.

Author: Barry Penzel, Douglas County Commissioner verbally at the RTC meeting on 10/26/16.

Response: The alignment for the Eastside Bypass shown in the Draft Plan connects to US 395 at the point where the future East Ranchos Connection meets the highway. This alignment provides a direct route from the Ranchos to the Eastside Bypass. The alternate alignment, proposed by Mr. Penzel, is attached. If the alternate alignment is implemented, vehicles leaving the Ranchos via the East Ranchos Connection would need to drive south on US 395 to access the Bypass. Additionally, the alternate alignment is approximately 6 miles longer, increasing the estimated cost by \$96 million. No change was made to the draft Transportation Plan in response to this comment.

8. **Comment:** Keith Ruben, representing the Dean Seeman Foundation, requested that the future Ironwood Drive Extension east of the East Minden Village Loop removed from the Plan. He is not opposed to having a local road at this location that would connect to Buckeye Road. However he does not feel that the road should be classified as a collector, especially since it is not needed to maintain acceptable levels of service through the 2040 planning horizon.

Author: Keith Ruben of RO Anderson Engineering verbally and in writing at the RTC meeting on 10/26/16.

Response: The Ironwood Drive Extension has been an adopted element of the Master Plan since the 1996 Transportation Plan. It connects two major collectors; the existing Ironwood Drive segment to the west, and Heybourne Road to the east which will be constructed as part of the road improvements for The Ranch at Gardnerville. The Ironwood Drive Extension provides an alternate route parallel to U.S. 395 in downtown Minden that would assist with relief of traffic congestion in that area. The right-of-way width requirement for a collector is 80 feet, verses 60 feet for a local road. Designation of this road segment as a local road is not appropriate. No change was made to the draft Transportation Plan in response to this comment. (See also comment #13.)

9. **Comment:** Nancy McDermid wants a statement in the updated plan that the Westside Bypass is not feasible due to flood plain and view shed issues, and the potential for a conservation easement that would conflict with the future roadway alignment.

Author: Nancy McDermid, RTC Vice Chair, verbally at the RTC meeting on 10/26/16.

Response: The Westside Bypass is not needed to maintain acceptable levels of service through the planning horizon of 2040. However, it is identified as a needed project in the 2007 report "*U.S. 395 Southern Sierra Corridor Study*", a current NDOT document. Also, it identifies a new road alignment. Accordingly, it remains in the updated Plan in the category "*Projects Needed for Alternate Local and Regional Access*". If constructed it would pass through existing AO and AE floodplains. It would also pass through the North-South Carson Valley View Corridor and the East-West Carson Valley View Corridor

as defined in the Douglas County Open Space and Agricultural Lands Preservation Implementation Plan, 2007. The elevation of the roadbed, if constructed, would not likely have a significant impact on views. No change was made to the draft Transportation Plan in response to this comment.

10. **Comment:** Gregg Lynn questioned the statement that all of the vested allocations would be built out by 2025 under the 1.39% Historic Growth Rate for population.

Author: Greg Lynn, RTC Chair, verbally at the RTC meeting on 10/26/16.

Response: Beginning with an estimated 2015 population of 49,800 and using a growth rate of 1.39% compounded annually for 10 years yields an estimated 2025 population of 57,200. This is a net increase in population of 7,400 persons. At 2.39 persons per household on average, this population increase equates to 3,100 new households. The total number of vested allocations from table 2.5 is 3,114. This indicates that, at a growth rate of 1.39% annually, nearly all of the anticipated growth between 2015 and 2025 could be accommodated by the tentatively approved subdivisions in the Minden/Gardnerville and Topaz Lake areas. However, development would not be restricted to these vested subdivisions. No change was made to the draft Transportation Plan in response to this comment.

11. **Comment:** Jo Etta Brown asked whether the updated Transportation Plan contains recommendations for future transit services. She also asked about the status of the transit services provided by the Tahoe Transportation District.

Author: Jo Etta Brown, Planning Commissioner, verbally at the 11/8/16 meeting of the Planning Commission.

Response: Chapter 5, the Public Transportation Element of the updated Transportation Plan recommends that the County prepare a short-range transit plan within the next three years to determine the logistics of implementing improved local transit services. Issues to be considered include expanding service hours and service areas, connecting rural communities, increasing frequency of demand-responsive services, developing transit system goals and objectives, developing a comprehensive transit financial plan, and preserving a transit corridor along the former V&T Railroad right-of-way. Regarding changes to the transit services provided by the Tahoe Transportation District (TTD), effective October 2, 2016 transit route 19x was suspended and routes 19x, 20x and 23 were modified. It is the nature of transit systems to be always changing. Section 5.1.3 BlueGo Transit Service contains a link to the BlueGo website where the current transit schedule can be found. No change was made to the draft Transportation Plan in response to this comment.

12. **Comment:** A question was raised about the source of future traffic that is driving the need to widen Dresslerville Lane and Riverview Drive from two lanes to four lanes.
Author: Planning Commission member, verbally at the 11/8/16 meeting of the Planning Commission.
Response: The Land Use Element of the Master Plan identifies several receiving areas within the Gardnerville Ranchos Community Plan. Two of the largest of those receiving areas are located immediately adjacent to Long Valley Road/Dresslerville Road on the east side of the road and adjacent to the existing development on the south side of the Ranchos. Completion of Muller Parkway, needed to address level of service deficiencies downtown, will make the Dresslerville Road/Riverview Drive connection more attractive to traffic leaving and returning to the Gardnerville Ranchos. No change was made to the draft Transportation Plan in response to this comment.
13. **Comment:** There were suggestions that the functional classification for Ironwood Drive Extension be downgraded from a Major Collector to a local road.
Author: Two County Commissioners and several members of the public, verbally at the 12/1/16 meeting of the Board of County Commissioners.
Response: The Board of County Commissioners took no action regarding the Draft Transportation Plan at the meeting. The Board continued the item so that it could be heard by the next Board, after seating two new Board members in January 2017. A special meeting of the new Board was held July 17, 2017 to review the functional classification of Ironwood Drive. At the meeting Parsons recommended that Ironwood Drive Extension be designated as Not an Emergency Access Route. Those in attendance who had previously wanted a change in the functional classification were in agreement with this recommendation. Language has been added to the Transportation Plan under section 4.7 Emergency Access Routes and Flooding that reads "*Ironwood Drive Extension is specifically designated as not an Emergency Access Route.*"

FOR INTERNAL USE ONLY: NOT FOR PUBLICATION OR DISTRIBUTION

Map Elements

- By-Pass Corridor

Land Ownership

- Other Lands

Common

- Private
- BIA
- BLM
- USGS Contours
- 911 Addressed Locations

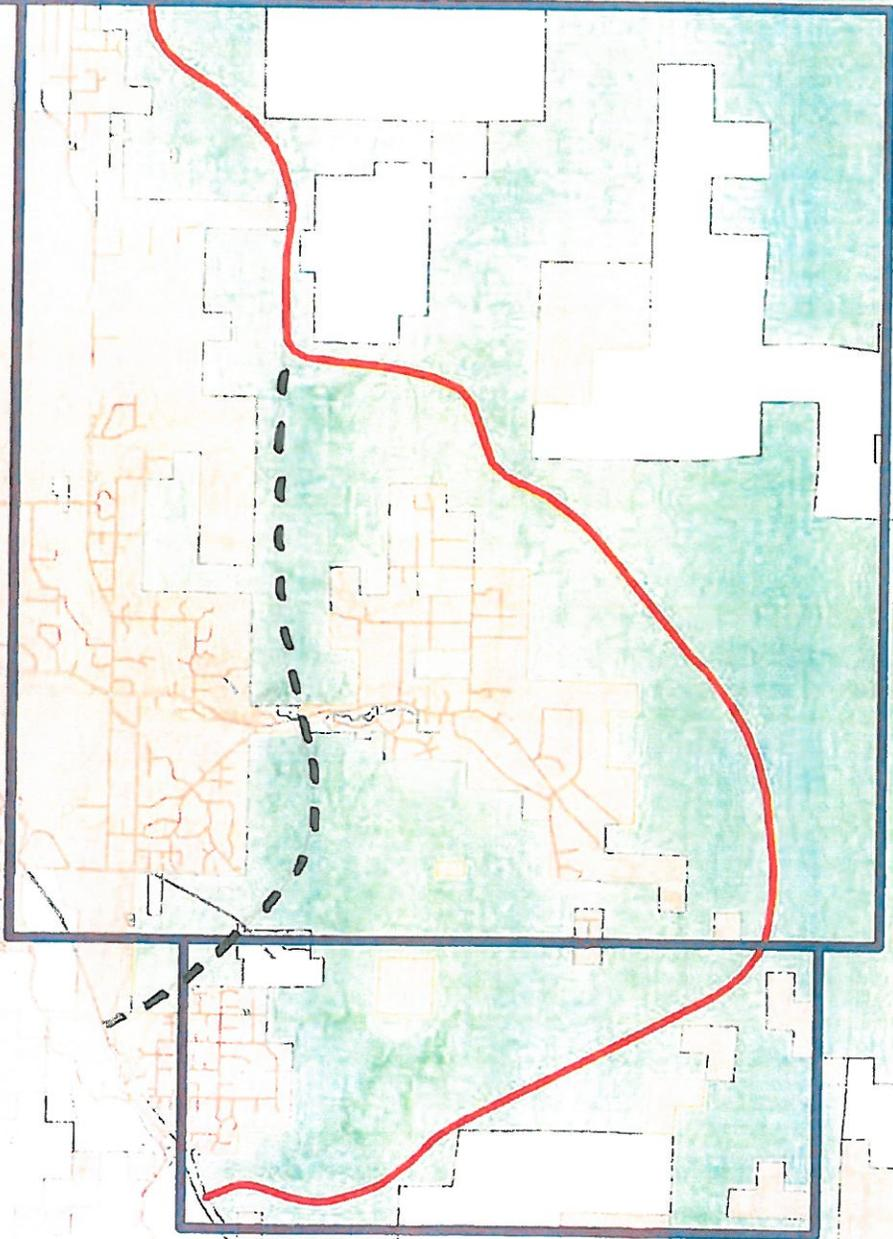



APPENDIX D

Complete Streets Policy Statement

Douglas County RTC



DOUGLAS COUNTY MASTER PLAN
2017 Douglas County Transportation Plan



PUBLIC WORKS

1120 Airport Rd., Bldg. F-2, Minden, Nevada 89423

Carl Ruschmeyer, P.E.
DIRECTOR

775-783-6480
775-782-6266

website: www.douglascountynv.gov

Water/Sewer Utility
Road Maintenance
Bldg. & Fleet Services

Douglas County Complete Street Policy Statement

Policy Statement: In the County of Douglas, Nevada, Complete Streets are designed, operated, maintained and enforced to provide safety and accessibility for ALL users of our roadways, including pedestrians, bicyclists, motorists and transit users of all ages and abilities. By adopting this Complete Street Policy, the Douglas County Regional Transportation Commission not only expects but recognizes:

1. All project proposals should strive to make the existing street network safer and better for all motorists, transit users, bicyclists and pedestrians.
2. The importance of routine planning, design, connectivity, operation, maintenance and enforcement of streets to be safe for travelers of all ages and abilities, regardless of mode.
3. All projects requiring approval from the County (public and private) including all new development proposals, infrastructure, and roadway maintenance projects should be designed as Complete Streets.
4. To provide context sensitive, aesthetic improvements for new and existing roadways that best meet the needs and desires of the community.
5. Site contextual design and engineering of complete streets solutions consistent with current best practices and from nationally recognized standards.

Definition: Complete Streets are streets intended for everyone's use. Complete Streets are designed and operated to enable safe access and comfortable accommodations for all users of all ages and abilities including pedestrians, bicyclists, transit riders, and motorists. As an added benefit, Complete Streets support economic development and enhances the visual experience for users.

In addition to accommodating motorists on the roadway, Complete Streets focuses on the needs of travelers outside that group, those with disabilities, and those who travel by transit, bicycle, or on foot, and who have oftentimes been overlooked in the transportation planning process. Many neighborhoods lack safe places to walk or bicycle. Access to key community resources such as parks, shops grocery stores, and schools, is often limited to automobile traffic.

Complete Streets is about safety and efficiency as well. Many people are injured or killed each year while walking or bicycling and frequently the constructed environment is a contributing factor. Though the County has historically had relatively few accidents involving pedestrians and bicyclists, they have occurred and there is always room for improvement. In terms of efficiency, improvements can be made to the transit infrastructure to better accommodate the movement of buses and ease the transition between modes of travel. Complete Streets seeks to develop integrated, connected networks of streets that are safe and accessible for all people. Complete Streets makes active transportation such as

walking and bicycling more convenient; provides increased access to employment centers, commerce, and educational institutions; and allows more traveling options so that transportation is less of a financial burden. Complete Streets also improve the quality of life in the community by enhancing the aesthetic environment. The term "Complete Streets" means much more than the physical changes to a community's streets. Complete Streets means changing transportation planning, design, maintenance, and funding decisions. A Complete Streets policy ensures that, from the start, projects are planned and designed to meet the needs of every community member, regardless of their age, ability, or how they travel. Doing so allows a community to save money by getting the design right the first time and avoiding costly retrofits, accommodating more people by improving options for those that may be limited by existing mode choices, and creating an environment where every resident can travel safely and conveniently. Complete Streets provides a better quality of life, often through measurable environmental benefits, and can spur economic development.

All Users/Modes: The need for streets that are designed, built, and operated to accommodate pedestrians and bicyclists as legitimate users of the transportation system, in addition to motorized users, cannot be understated. However, this policy must be applied to take into consideration not only various modes, but the needs of the individual and unique users across those modes. Infrastructure improvements must consider the needs of families, youth and the elderly, those with varying physical abilities, diversity of income levels, and cultural identity and values.

Improvements should also accommodate a variety of users within specific modes. For example, where appropriate, accommodations for motorized vehicles include motorcycles, freight, and buses to name a few. In addition to pedestrians and bicyclists, improvements should consider skateboards, strollers, wheelchairs and other means of active transportation. Consideration should be given not only to the types of individual modes, but the ease of transition between them. Oftentimes, people rely on multiple modes to reach their destination which, at a minimum, generally requires some amount of walking.

All Projects/Phases: This policy must apply to all phases of a project from the initial planning, through design, and during construction. Once a project is constructed, the planned maintenance and operations of facilities should be viewed in light of this policy. Whether the project is of new construction or retrofitted, large or small in scope, Complete Streets should be an aspect of the project at all stages. The entire right-of-way, and not just the roadway, should be included in the focus on any project.

Funding may be an obstacle to implementing projects and achieving the desired outcome. This policy recognizes that it may not always be feasible to construct an entire project at one point in time that is entirely inclusive of Complete Streets goals. However, it is intended that a continued effort and commitment will be demonstrated to achieve Complete Streets incrementally through a series of smaller improvements when this is the case.

Exceptions: There may be certain exceptions to implementing Complete Streets on a small number of projects. However, each project should be carefully evaluated and have documented justification as to why it is not feasible or practical to implement all Complete Streets measures. The following is a list of a

few possible exceptions or situations that may prevent the implementation of Complete Streets measures.

1. Accommodation is not necessary on corridors where specific users are prohibited, such as interstate freeways.
2. The cost of accommodation is excessively disproportionate to the need and potential benefit of the probable use. A cost-benefit analysis should be applied to reach this determination in situations where there is not a clear benefit.
3. A documented absence of current and future need. The existing and planned population, employment densities, traffic volumes, or level of transit service around a particular roadway is so low that future expected users of the roadway will not include pedestrians, public transportation, freight vehicles, or bicyclists.
4. The project involves only ordinary maintenance activities designed to keep assets in acceptable condition, such as cleaning, sealing, spot repairs, patching and surface treatments, such as micro-surfacing.

Network: Projects should be implemented so as to establish connectivity within the existing street network. Developing connections to existing pedestrian and bicycle facilities whenever possible is encouraged and will improve the overall safety and accessibility to those that are dependent on those modes. Complete Streets concepts should be applied to private developments where feasible to eliminate “islands” with no connection to the outside network. The private sector should be held to Douglas County standards and to the essence of Complete Streets concepts for proposed developments to ensure that the intent of this policy carries through approved site plans and the entire development process.

Jurisdiction: This policy applies to all Douglas County-funded projects as well as privately funded projects or developments within Douglas County. To the greatest extent possible, County staff will work with Towns, State and Tribal entities to encourage them to implement Complete Streets concepts on projects within their respective jurisdictions.

Design Recommendations: Douglas County will attempt to utilize the best and latest design standards available and will refer to those nationally accepted standards when implementing projects. The following is a list of sources that provide nationally recognized standards:

- The National Complete Streets Coalition – <http://CompleteStreets.org>
- The National Association of City Transportation Officials (NACTO) Urban Bikeway Design Guide – <http://nacto.org/cities-for-cycling/design-guide/>
- American Association of State Highway and Transportation Officials (AASHTO) Guide for the Development of Bicycle Facilities – https://bookstore.transportation.org/collection_detail.aspx?ID=116
- Public ROW Accessibility Guidelines (PROWAG) – <http://www.accessboard.gov/guidelines-and-standards/streets-sidewalks/public-rightsofway/background/revise-draft-guidelines>
- Federal Highway Administration (FHWA) <http://safety.fhwa.dot.gov>

- Douglas County 2014 Bicycle Plan
<http://www.douglascountynv.gov/documentcenter/view/3936>

Context Sensitivity: Above all, flexibility must be retained when choosing design standards for various elements of a project, realizing that not all standards lend themselves to a “one size fits all” approach. Innovative practices should be researched and considered where appropriate. Public input should be sought from residents and non-residents alike that will be directly affected by a proposed project. A design that might be appropriate for one area of the community may not be acceptable in a different area. The underlying concept behind Complete Streets is to design for the needs of the users of the roadway.

ADOPTED ON THIS 19 day of January, 2016, by the Douglas County Regional Transportation Commission.

Carl Ruschmeyer, P.E. Director of Public Works



Greg Lynn, Chairman, Douglas County Regional Transportation Commission



Nancy McDermid, Douglas County Regional Transportation Commission



Bobby Wartgow, Douglas County Regional Transportation Commission



PARSONS

3480 GS Richards Boulevard, Suite 202
Carson City, Nevada 89703
Tel: (775) 885-8571
www.parsons.com